

USPAS Project Discussion

Tom Peterson and John Weisend

June 2019

USPAS Project Statement

- A new proton linear accelerator (The Buckytron) is being built to provide high energy protons to a target that produces neutrons via the spallation process. The bulk of the accelerator consists of Niobium superconducting RF cavities operating in saturated helium baths at 1.8 K.
 - Six cavities are contained within one cryomodule.
 - A total of 40 cryomodules are required.
 - In addition to the cavities, each cryomodule also contains a 40 K thermal radiation shield.
 - Each cavity has a coaxial coupler to bring the RF energy into the cavity.
 - Each coupler has a 20 W load at 40 K and a 1 W load at 1.8 K.

Buckytron description – pg 2

- Each cryomodule is 8 m in length and 0.75 m in diameter.
- Between each cryomodule is a 3 m long warm (300 K) section that contains magnets and beam instrumentation.
- When operating, the RF energy deposits 7 W into the 1.8 K space per cryomodule.
- The total deposited by the proton beam into the 1.8 K space is 10 W.
- The linac is contained in a 10 m diameter tunnel located 20 m below the surface.

Project goal

- Based on this information, design the cryogenics system for the accelerator. The cryogenic system includes: The cryomodule, the refrigeration plant or plants and the distribution system if needed to tie the refrigeration plant(s) to the cryomodules as needed. Include in this design:
 - A list of information you will need from other groups in the accelerator project
 - Definition of requirements for both the cryomodule and the cryogenics system

Conceptual design elements

- A conceptual design for the cryogenics system should include:
 - A conceptual design of the cryomodule including an estimated heat leak
 - A high level Piping & Instrumentation Diagram (P&ID) for the cryogenics system
 - A conceptual design for any distribution system including pipe sizes, estimated heat leaks, pressure drops and required valves
 - Number and size of cryogenic refrigeration plants. These do not have to be designed but will be procured from a commercial vendor

Conceptual design elements – pg2

- Build safety into the conceptual design; include relief valves as needed Consider impact of venting on oxygen deficiency hazards
- Assume that all subsystems associated with the superconducting RF system including the cavity design itself, power supplies, control, and power coupler design are provided by other groups.

Bonus topics

- Discuss how the system will handle possible operating modes including cool down and warm up
- Consider standby (cold but no beam or RF energy present), lower heat loads and flow rates
- Describe any prototyping or testing you feel would be required
- Describe design alternatives considered

Options, examples

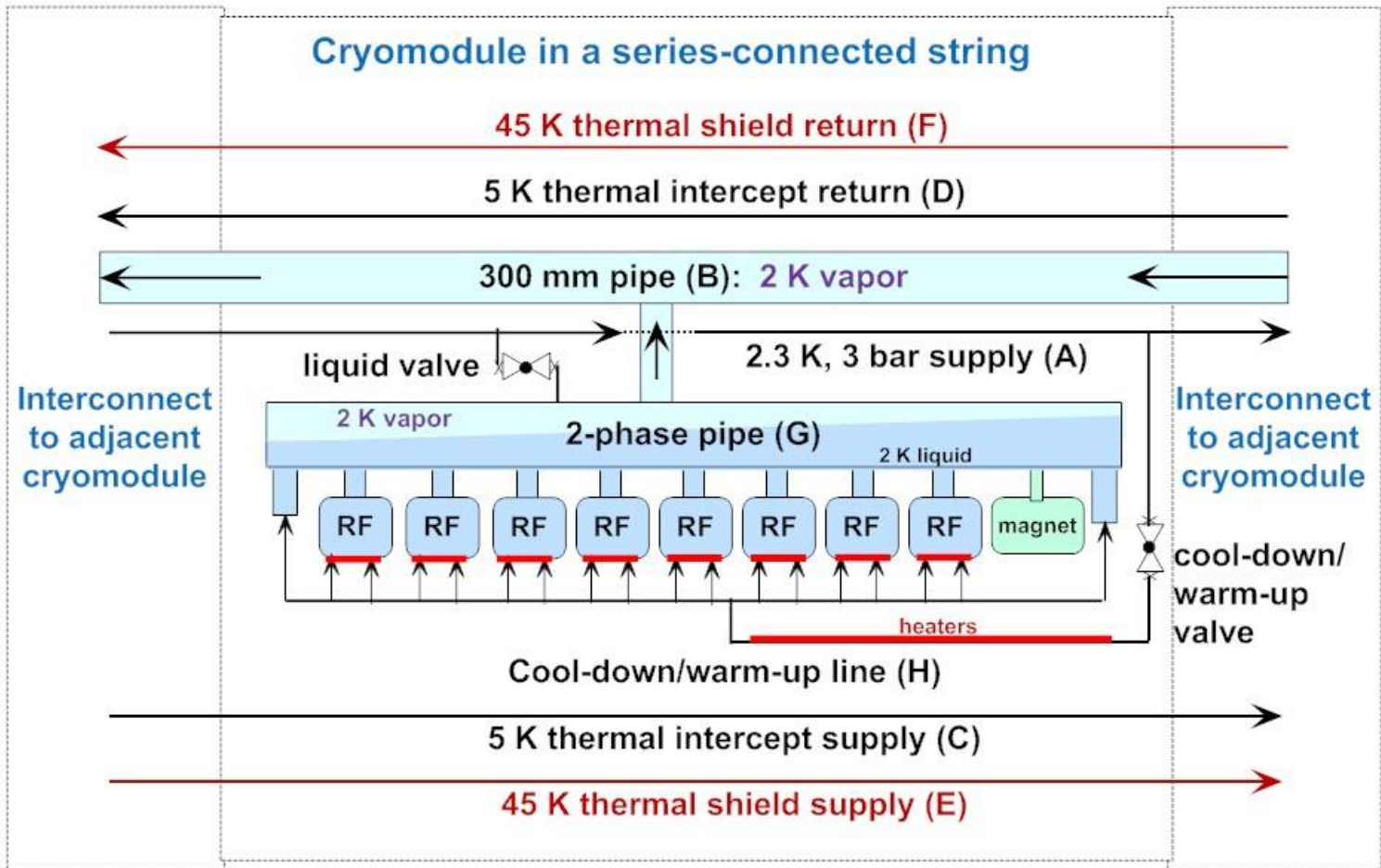

3.9 GHz cryomodule section

Pipes same as for 1.3 GHz

50 K thermal shield return (F)

5 K thermal intercept return (D)

Warmup/Cooldown (H, not shown)

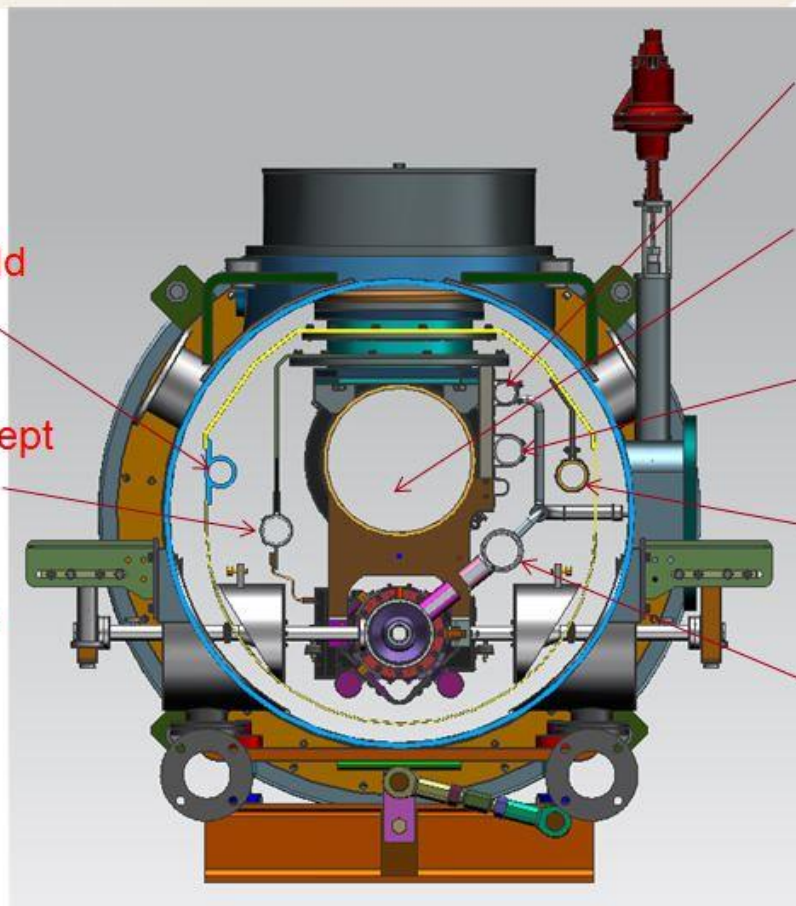

2.2K Helium supply pipe (A)

Helium gas return (B)

5 K thermal intercept supply (C)

50 K thermal shield supply (E)

2-Phase helium pipe (G)

Peterson, LCLS-II Cryomodule Design, 18 April 2016

50

LCLS-II cryomodule cryogenic circuits

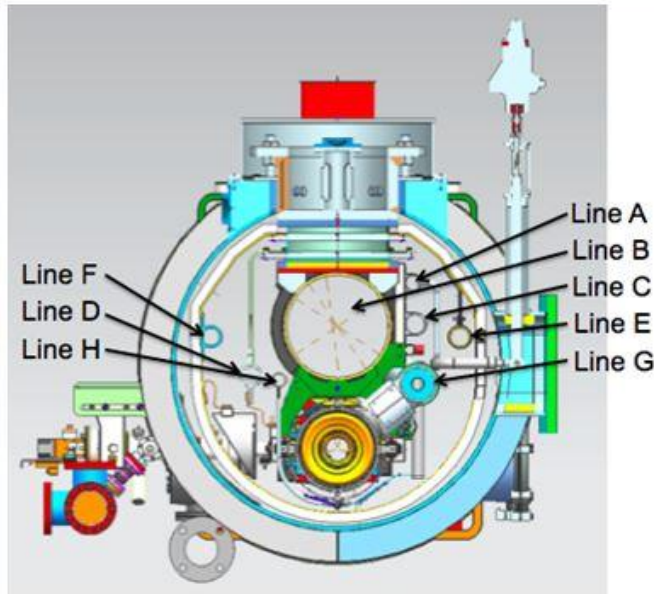

Circuit (Line)

- A. 2.4 K subcooled supply
- B. Helium gas return pipe (HGRP)
- C. Low temperature intercept supply
- D. Low temperature intercept return
- E. High temperature shield supply
- F. High temperature shield return
- G. 2-phase pipe
- H. Warm-up/cool-down line

Operating Parameters	A	B	C	D	E	F	G	H
Pressure, [bar]	3	0.031	3.2	2.5	3.7	2.7	0.031	3
Temperature, K	2.4	2.0	5.5	8.0*	35	55	2.0	2.0

*Line D returns 1.3 bar, 7.5 K to cryogenic plant after expansion valve

Helium vessel styles

"Closed" versus "open" helium vessels

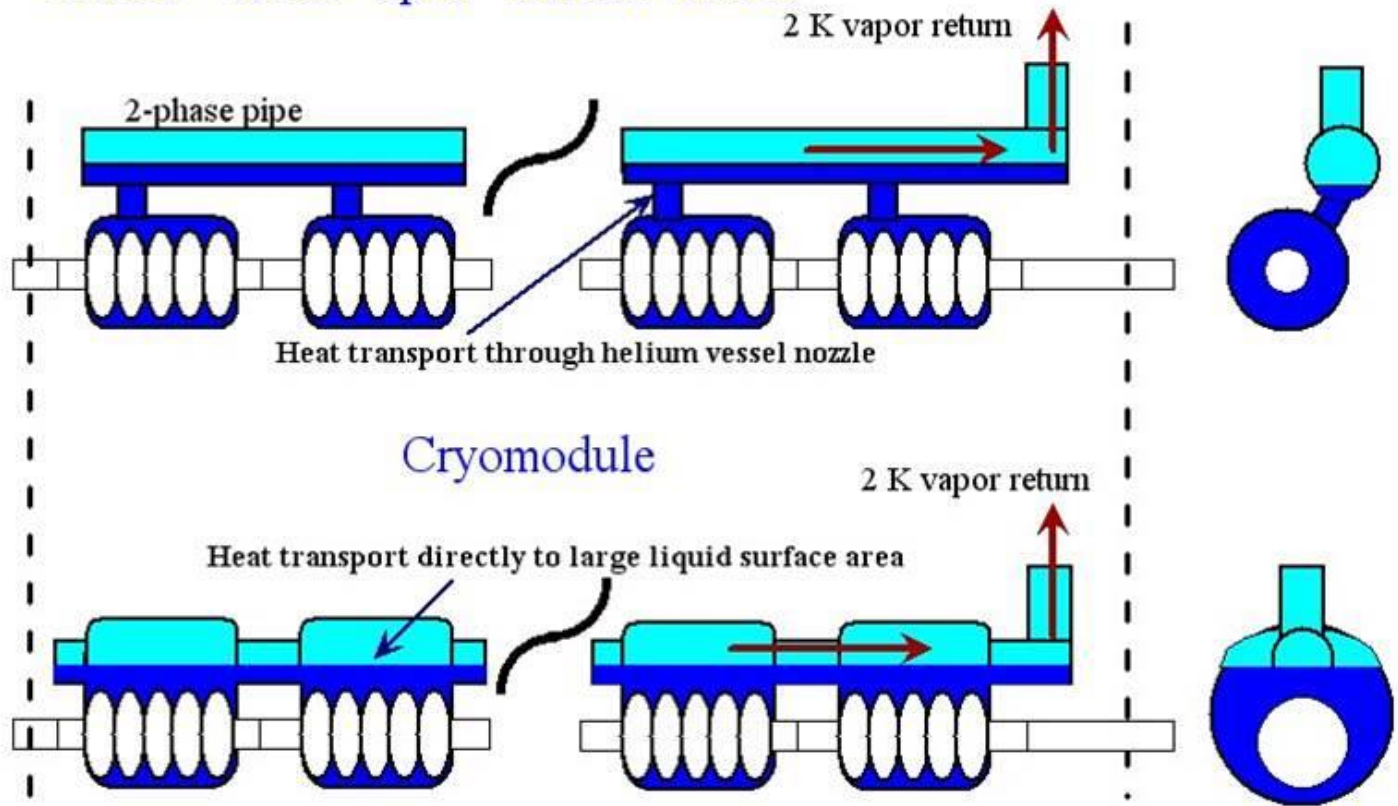

ESS distribution system

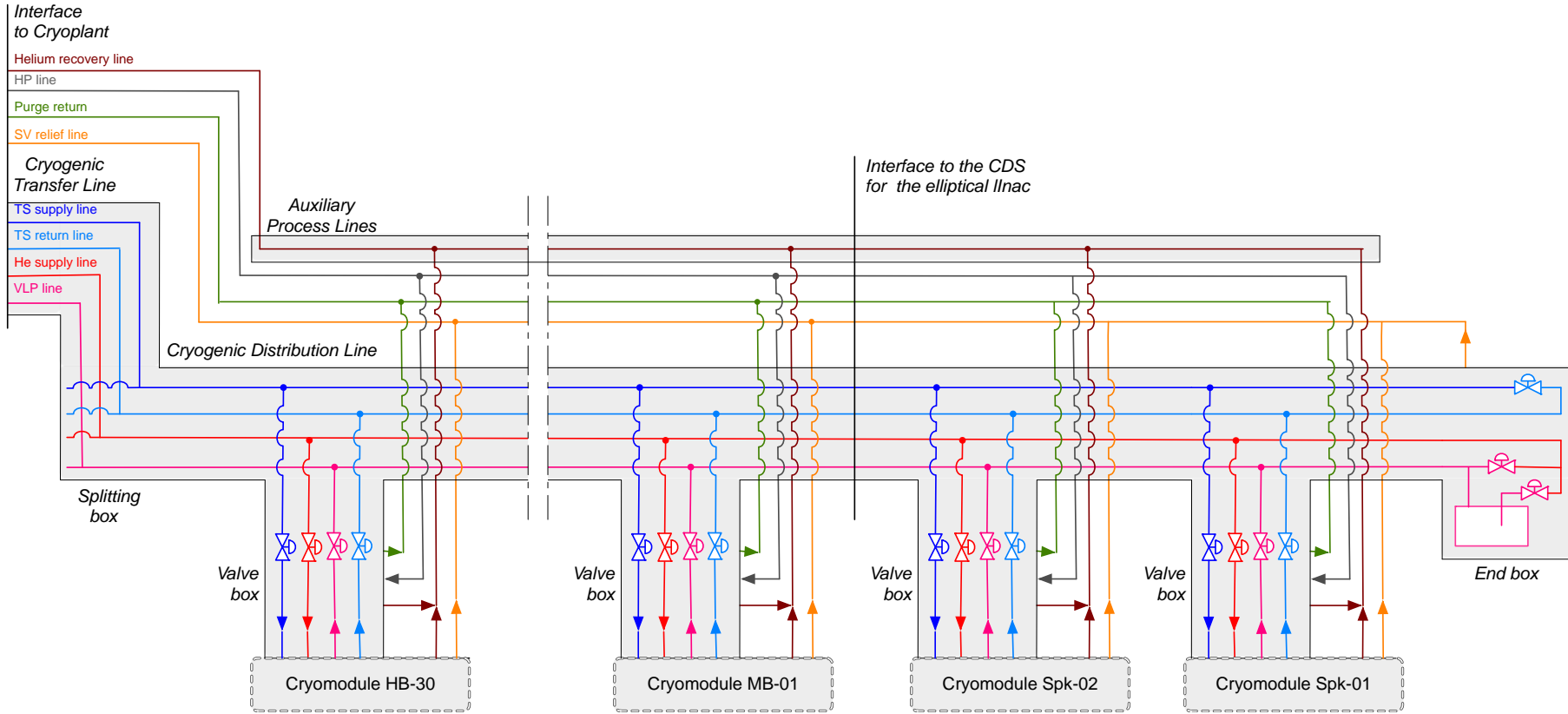

FRIB linac folded layout

Cryomodule Scope Reduction of Two Cryomodules as Results of Folding Segment Optimization

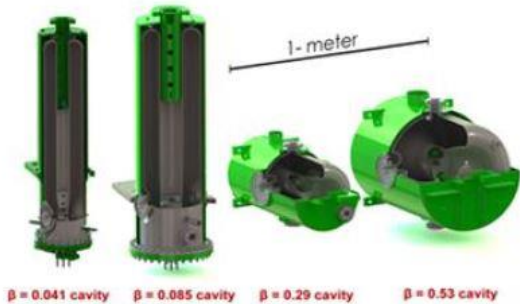
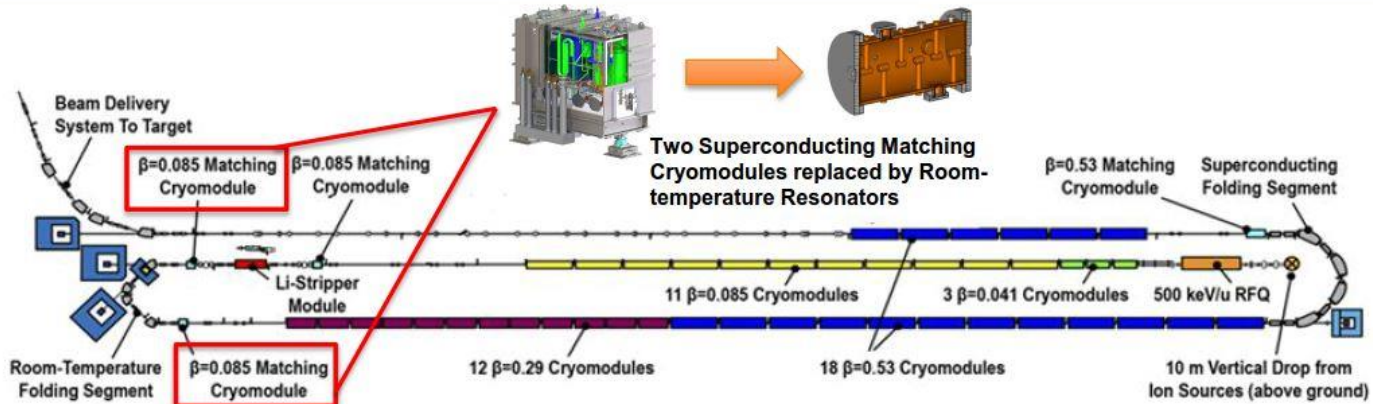

Quarter Wave Cryomodule				
		Number of Cryomodules	Number of Cavities	Number of Solenoids
$\beta = 0.041$	Accelerating Cryomodules:	3 + 1 spare	12 + 4 spare	6 + 2 spare
	Matching Cryomodules:	1 + 1 spare	4 + 4 spare	-
$\beta = 0.085$	Accelerating Cryomodules:	11 + 1 spare	88 + 8 spare	33 + 3 spare
	Matching Cryomodules:	1 + 1 spare	4 + 4 spare	-
Half Wave Cryomodule				
$\beta = 0.29$	Accelerating Cryomodules:	12	72	12
$\beta = 0.53$	Accelerating Cryomodules:	18	144	18
	Matching Cryomodules:	1	4	-
TOTAL		46 + 3 spare	324 + 16 spare	69 + 5 spare

Thermal shield example

- Assuming a thermal shield with 18 bar helium in and some lower pressure out due to pressure drop, like 16 bar. (Higher pressure gives higher density for less pressure drop and smaller pipes.) However, you may choose otherwise!
 - Estimate heat load to 40 K per cryomodule (e.g, 100 W)
 - Given a temperature range for helium gas (say for example 40 K to 60 K) determine how much heat is absorbed per gram of helium for each cryomodule
 - In this example it would be 106.5 J/g. (It is nearly an ideal gas with $C_p = 5.2$ J/gK, which you may assume. $20 \text{ K} \times 5.2 \text{ J/gK} = 106.5 \text{ J/g}$)
 - Divide total heat for the cryomodule in W by amount absorbed in J/g to get g/sec flow
 - In this example: $100 \text{ W} / 106.5 \text{ J/g} = 0.94 \text{ g/sec}$ per cryomodule

For example power and flow

- See ILCcryoTDP-26June2012.xlsx
- Check the tabs “TDS power”
 - Input assumptions are pressure and temperature desired for supply and return
 - From that we have enthalpy and entropy change
 - And then from the heat load we find mass flow rate
 - Those provide input for Ideal Power

Evaluating cooling power

$$P = \dot{m} \{ T_{amb} (s_{out} - s_{in}) - (h_{out} - h_{in}) \}$$

PRESSURE = 0.180 [MPa]

	TEMP [K]	DENSITY [kg/m ³]	PV/RT [-]	ENERGY [J/g]	ENTHALPY [J/g]	ENTROPY [J/g·K]	C _V [J/g·K]	C _P [J/g·K]
	4.200	129.8	0.1590	8.690	10.08	3.442	2.508	4.504
	4.500	122.9	0.1566	10.12	11.59	3.789	2.570	5.696
	4.800	112.2	0.1609	12.09	13.69	4.240	2.641	9.190
L	4.891	106.7	0.1661	12.98	14.67	4.442	2.675	13.04
V	4.891	34.01	0.5209	23.57	28.87	7.339	3.080	21.98
	5.000	29.78	0.5819	24.69	30.73	7.717	3.100	14.14
	60.00	1.438	1.004	202.0	327.2	22.03	3.119	5.202
	80.00	1.080	1.003	264.5	431.2	23.53	3.118	5.197
	100.0	0.8643	1.003	326.8	535.1	24.69	3.117	5.195
	280.0	0.3092	1.001	887.8	1470.	30.03	3.116	5.193
	300.0	0.2886	1.001	950.1	1574.	30.39	3.116	5.193
	350.0	0.2474	1.001	1106.	1833.	31.19	3.116	5.193

Liquefier work

- From previous slide and data for 80 K flow returning at 300 K
 - 915 J/g ideal work is 915 W per gr/sec which at 25% relative to Carnot is 3660 room T Watts per gram/sec
 - 3660 room T power is equiv to $3660/250 = 15$ W at 4.5 K
- So each gr/sec taken from 80 K and returned at 300 K is equivalent to 15 W at 4.5 K in terms of room temperature cryogenic plant work
- For 4.5 K flow returning at 300 K a similar analysis shows
 - 6420 J/g ideal work which is 6420 W per gr/sec which at 25% relative to Carnot is 25700 room T Watts per gram/sec
 - Note that 100 W at 4.5 K x 257 W/W would be 25700 W
 - So 4.5 K liquefaction of 1 gr/sec is ~ equiv to 100 W at 4.5 K