



Unit 17

Degradation and Training II

Soren Prestemon and Steve Gourlay

Lawrence Berkeley National Laboratory (LBNL)



Outline



- Introduction
- Degradation or energy deposited quenches?
 - Ramp-rate dependence studies
 - Temperature dependence studies
 - Voltage signal studies
- Training
 - Definition
 - Causes
- Frictional motion
- Epoxy failure
- Overview of training performance
- Summary



- We will address the following question
 - How do we establish if a magnet
 - reached its limit?
 - is degraded?
 - is limited by conductor motion or flux jumps?
 - What is “training”?
 - What are the possible causes?



Degradation or energy deposited quenches?



- A magnet quenches at a current lower than I_{SS} : is it a conductor-limited/degradation quench or a energy deposited quench?

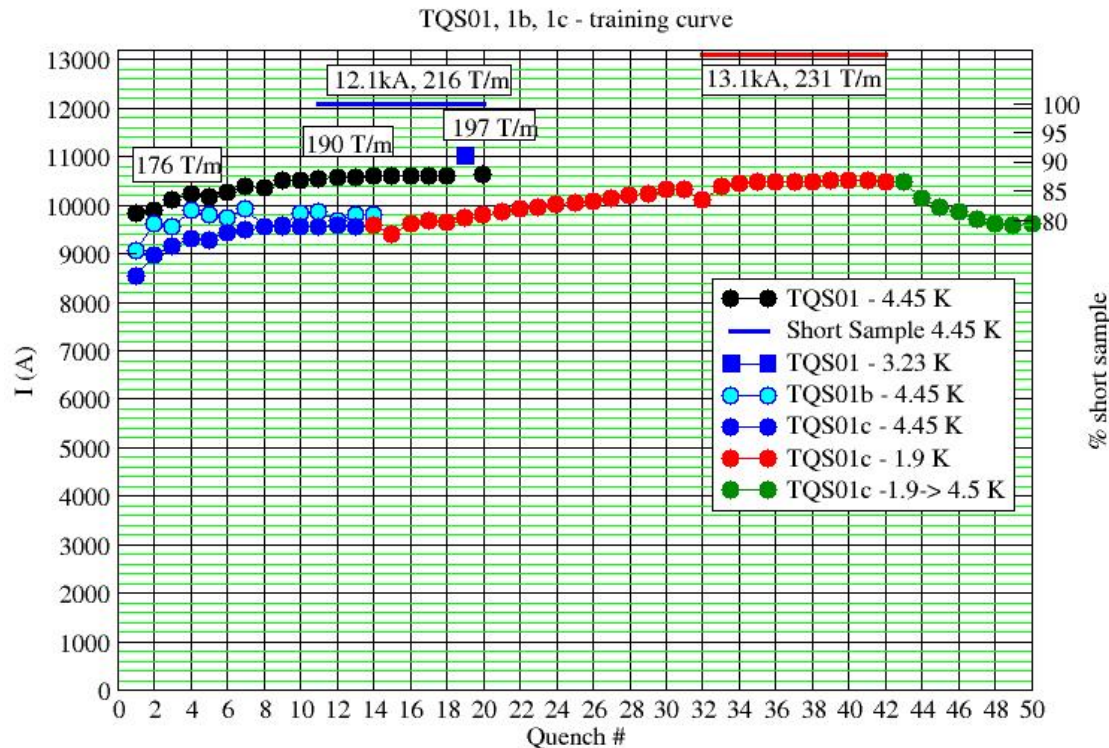

- In general the answer is never easy, but four types of analysis may give us some information.



Degradation or energy deposited quenches?



- 1) Temperature dependence studies
 - Since conductor limited quenches occur when the magnet current passes the critical current at a given temperature, they are very sensitive to temperature
 - One of the way to check if a magnet reached the conductor limit is to vary the temperature, and verify if the maximum current is “moving” along the critical surface.

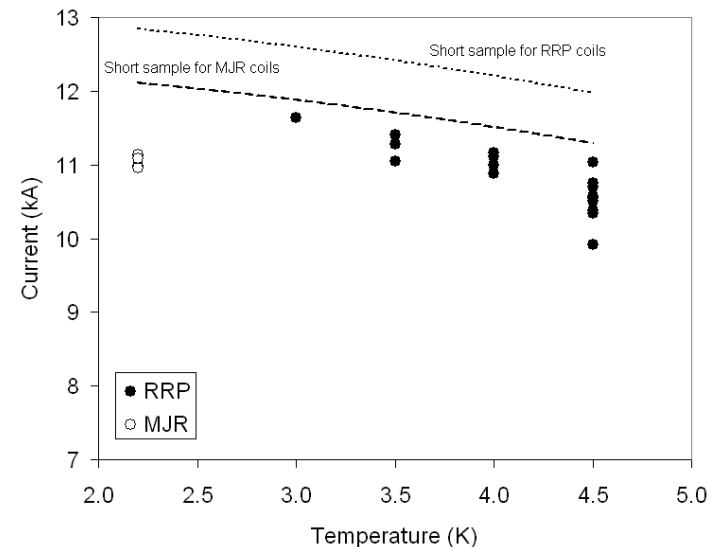
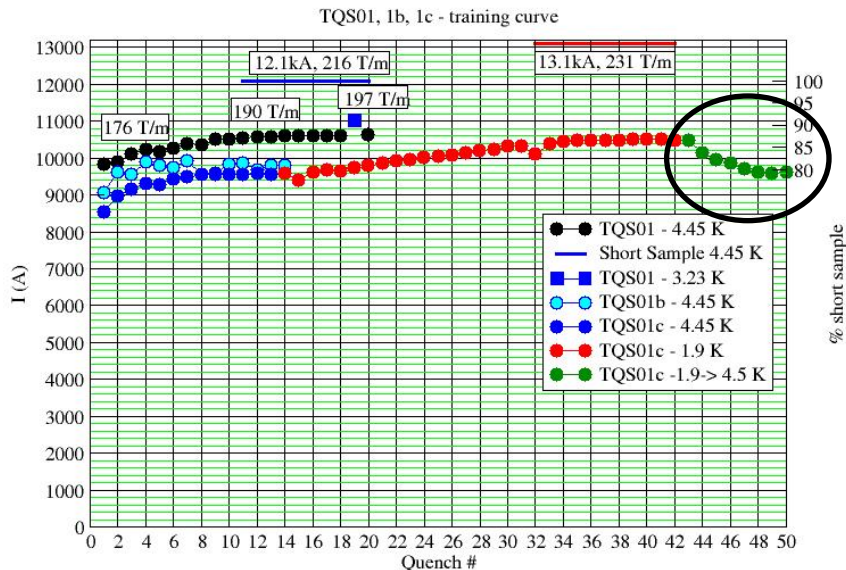



- 2) Ramp-rate dependence studies
 - Ramp-rate quenches are induced by AC losses. At high ramp rate, AC losses can dominate over the other quench causes.
 - A reduction of the ramp rate, and consequently of the AC losses, should produce, in the absence of other possible causes of premature quenches, a “smooth” increase of quench current to the conductor limit.
 - A sharp change in the quench current vs. ramp-rate curve can represent an indication of a magnet not limited by the conductor.

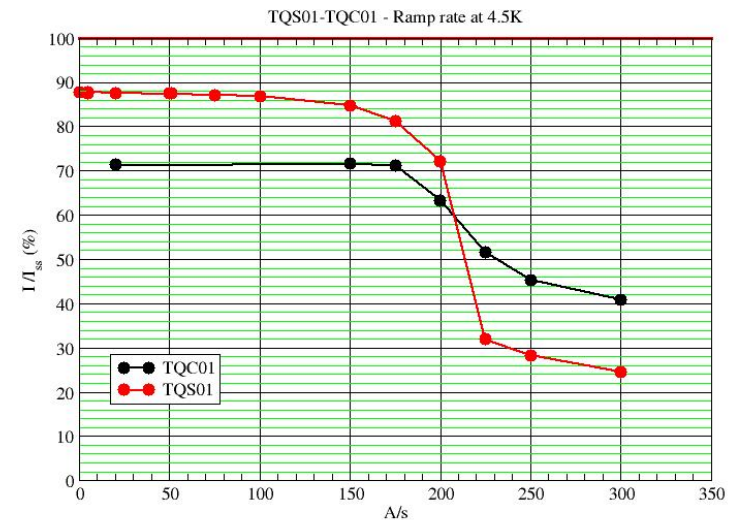
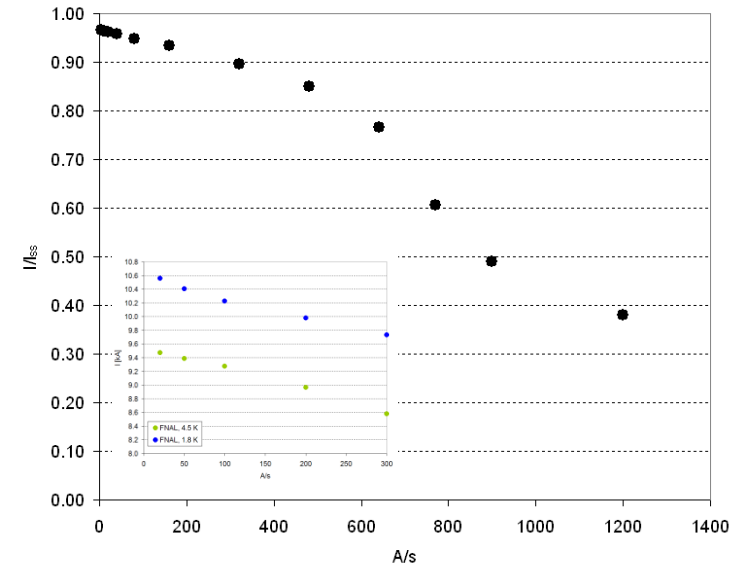



Degradation or energy deposited quenches?



- 3) Voltage signal studies
 - Quench have different voltage precursors.
 - A motion or a flux jump generates a change in magnetic flux inside the winding.
 - A variation of magnetic flux results in a voltage signal detected across the coil.
 - Depending on the shape of the voltage signal, it is possible to identify
 - Conductor limited quenches: slow, gradual resistive growth
 - Flux jump induced quenches: low-frequency flux changes
 - Motion induced quenches: acceleration-deceleration-ringing

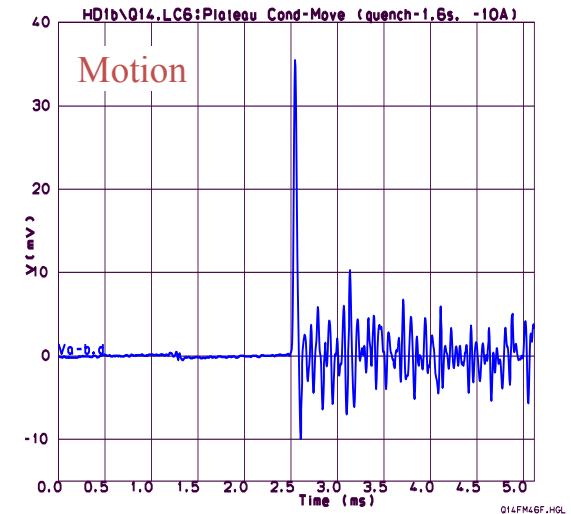
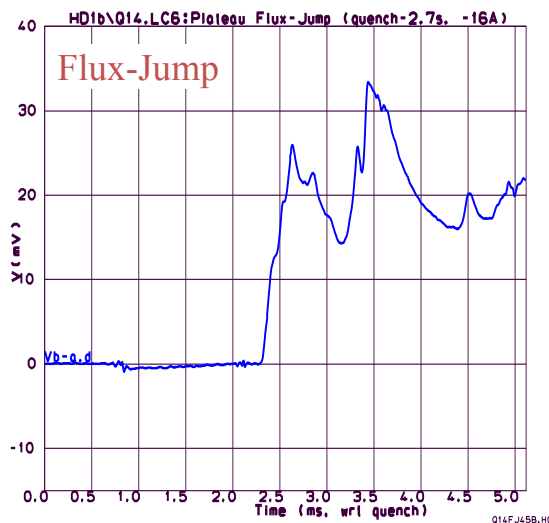
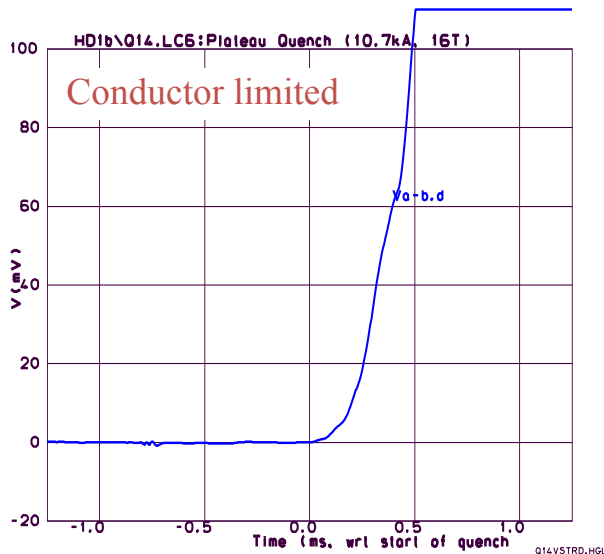



Training



TRAINING AND DEGRADATION PHENOMENA IN SUPERCONDUCTING MAGNETS

H. Brechna

Department of Electrical Engineering
Federal Institute of Technology
Zurich, Switzerland

P. Turowski

Kernforschungszentrum Karlsruhe IEKP
Federal Republic of Germany

I. INTRODUCTION

In the early 70's interest was centred upon a new phenomenon observed at CERN in two race track shaped epoxy impregnated coils¹⁾. While energized for the first time, they quenched at about 30% of the measured short sample current value. After numerous runs finally design values were reached. Interestingly enough many laboratories reported shortly afterwards a similar trend in race track shaped coils and even in solenoids. The phenomenon, that after each successive quench the transport current could be raised by some fraction yielding an improved performance of the conductor until design, or short sample value is reached, was termed "training".

The word training must not be blended with degradation, which is essentially a deficiency of the superconductor, a real inadequacy in the magnet design, since the magnet may never reach the calculated and predicted field values.

Proceedings of the 6th International Conference
on Magnet Technology, 1978. p. 597.



Training Definition



- Training is characterized by two phenomena
 - The occurrence of premature quenches
 - What are the causes?
 - The progressive increase of quench current
 - Something irreversible happens, or, in other words, the magnet is somehow “improving” or “getting better” quench after quench.
 - Some irreversible change in the coil’s mechanical status is occurring.
- In R&D magnets, training may not be an issue.
- For accelerator magnets it can be expensive, both in terms of time and cost.

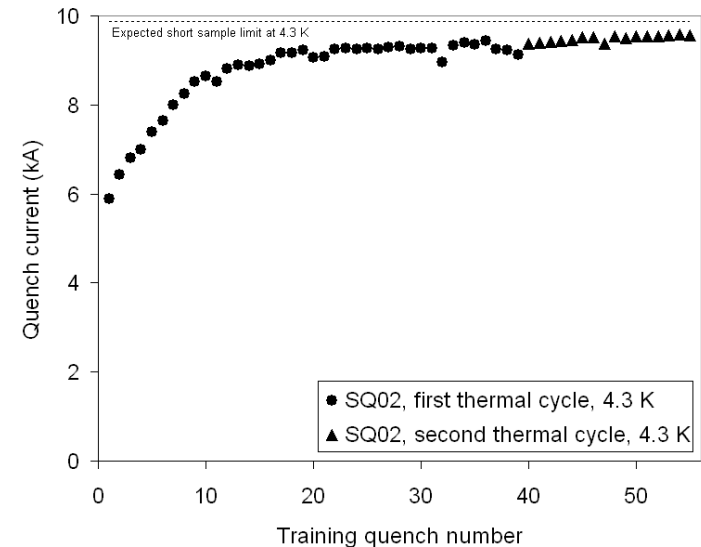
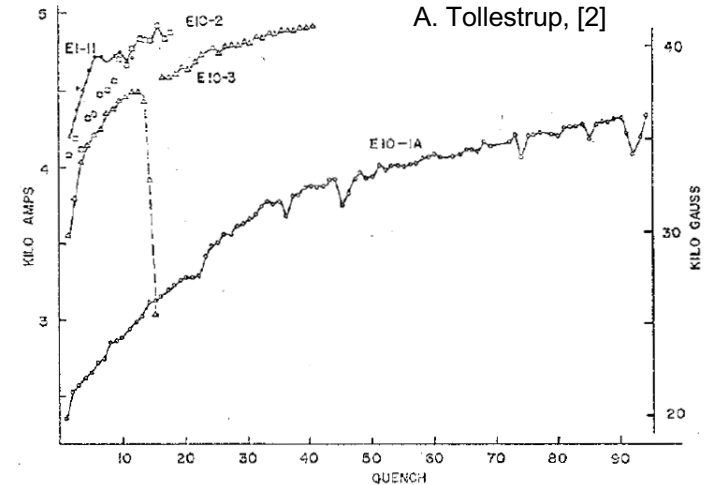



Training Causes



- Mechanically induced quenches are considered the main causes of training in superconducting magnets.
 - Frictional motion of a superconductor
 - During excitation electromagnetic forces determine conductor motion; any motion of a conductor in a frictional environment produces heat.
 - After each quench, the coil is partially locked by friction in a new and more secure state which allows the conductors to withstand higher levels of electro-magnetic forces.
 - Epoxy failure
 - Under the stress status induced by the mechanical structure and the e.m. forces, the coil stores strain energy. When a crack is initiated and propagates (for example in the resin), part of the original strain energy is dissipated as heat.
 - Premature quenches produced by epoxy cracking take place when the stresses in the winding exceed the epoxy's fracture stress. Once the epoxy is locally fractured, further cracking appears only when the e.m. stress is increased.



- The Coulomb friction (or static friction) model is defined as follows.
 - Let's consider two bodies in contact, being N the normal force exerted between the two surfaces.
 - We then apply to one of the two body a force F_{appl} parallel to the contact surface.

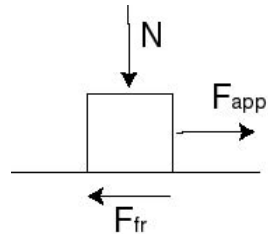

- The friction force is given by $F_{fr} \leq \mu N$ where μ is the friction factor.
- This means that the friction force depends on F_{app}
 - If $F_{app} \leq \mu N$, no sliding occurs, i.e. the friction force is (just) what is needed to prevent motion
 - If $F_{app} > \mu N$, sliding occurs, and the friction force is constant and equal to μN .



Frictional motion



- We can use a contact pressure P instead of force N , and frictional stress or shear stress σ_{fr} instead of F_{fr} .
- The Coulomb model can be reformulated as follows
 - Two surfaces can carry shear stresses σ_{fr} up to a magnitude of μP across their interface before they start sliding relative to each other.
- Whenever two surfaces slide with respect to each other in a frictional environment, frictional energy is dissipated. The frictional energy dissipated per unit area E (J/m^2) can be estimated as

$$E = \delta \sigma_{fr}$$

where δ (m) is the relative sliding of the two surfaces, and σ_{fr} (N/m^2) is the frictional stress between the two surfaces (in the direction parallel to the two surfaces).



Frictional motion



- Where does this frictional motion occur?
- Some examples
 - Azimuthal sliding between coil and collar because of azimuthal e.m. forces
 - Radial sliding between coil and collar because of radial e.m. forces
 - Axial sliding between coil and pole because of axial e.m. forces

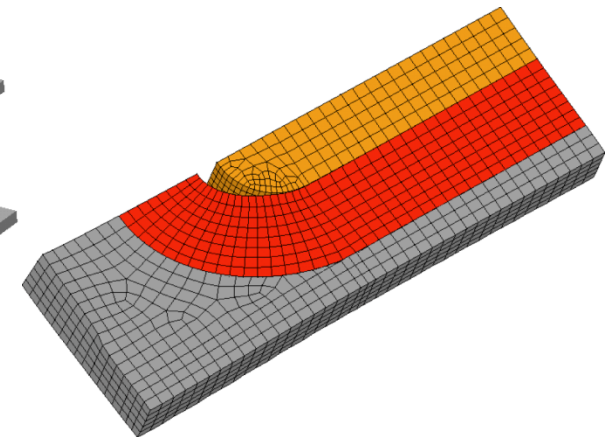
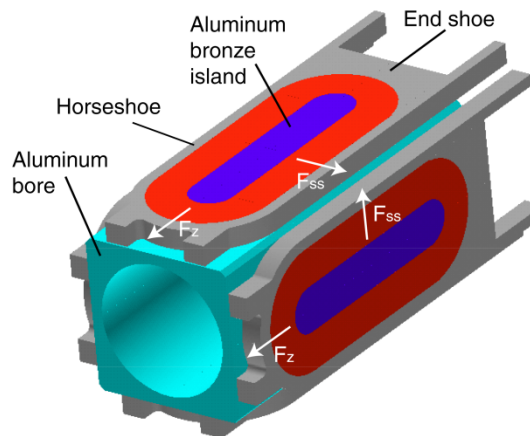
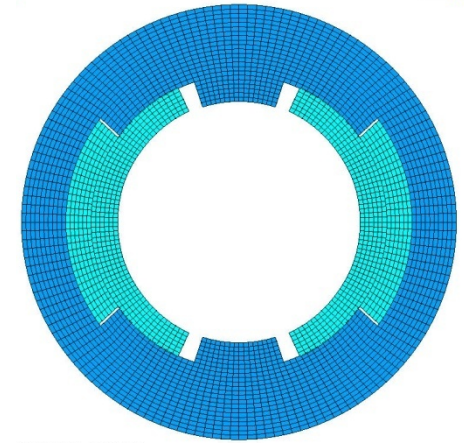
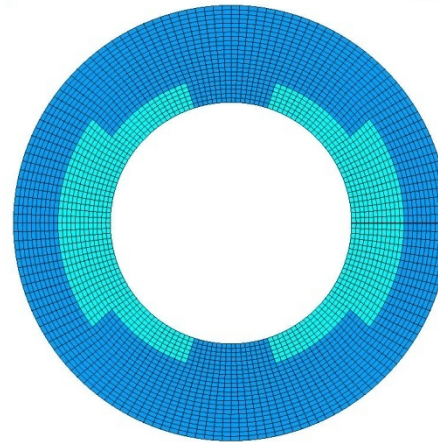



Frictional motion



- Some orders of magnitude

- Let's consider a contact pressure between coil and support structure (or between adjacent cables) P of about 30 MPa (LHC or SSC).
- With a friction factor $\mu = 0.3$, the maximum frictional stress will be

$$\sigma_{fr} = \mu P = 9 \text{ MPa}$$

- A relative sliding δ of about 1 μm will dissipate

$$E = \sigma_{fr} \delta \sim 10 \mu \text{ J/mm}^2$$

- 10 μJ was the computed MQE for the SSC dipole: a **very small** motion under friction can initiate a quench
- Fine, but how can we explain the progressive increase of quench current?



Frictional motion

- A simple analytical model has been proposed by O. Tsukamoto and Y. Iwasa [3].
 - A simple force cycle applied to a spring system shows
 - Irreversible displacement at the end of the first cycle
 - Reduction of total displacement in the second cycle

Y. Iwasa, [4]

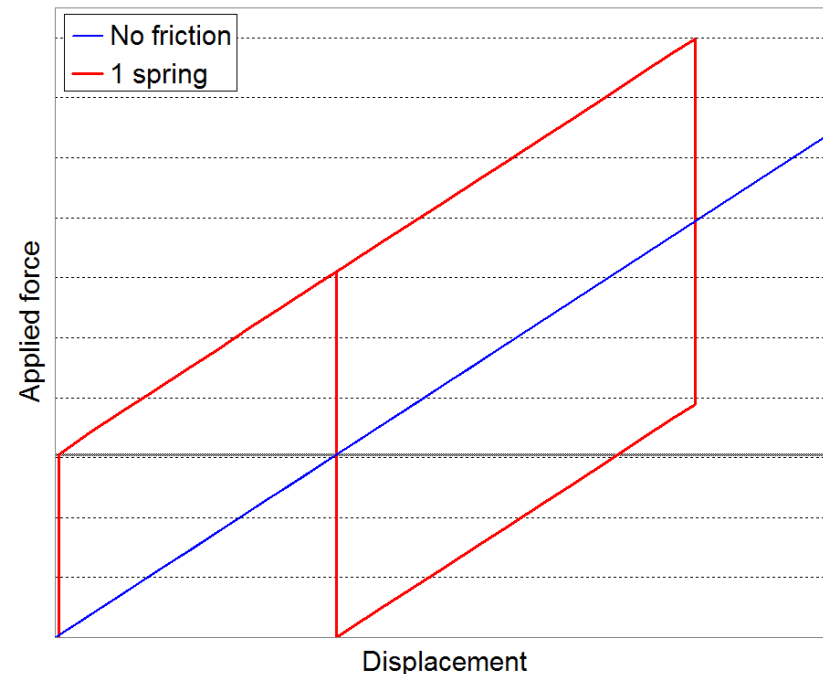
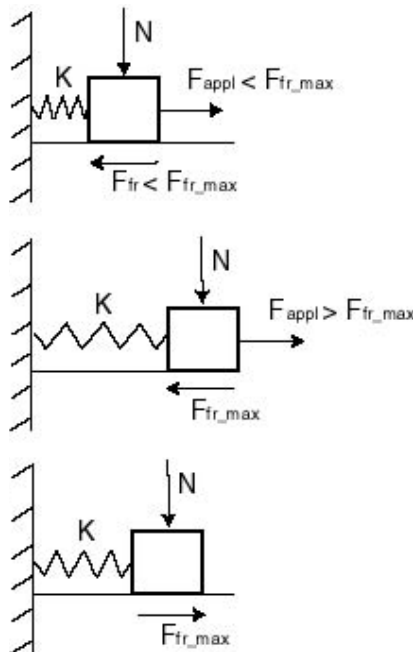
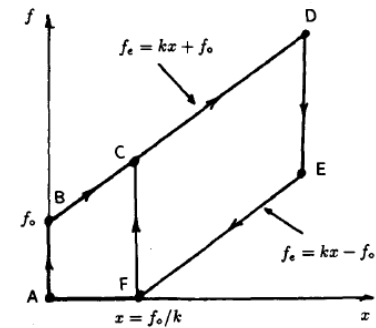



Frictional motion



- If we consider three springs, the transition from stick to sliding is more gradual, both during the increase of force and the decrease of force.
- With increasing or decreasing applied force, the bodies start sliding one after the other.

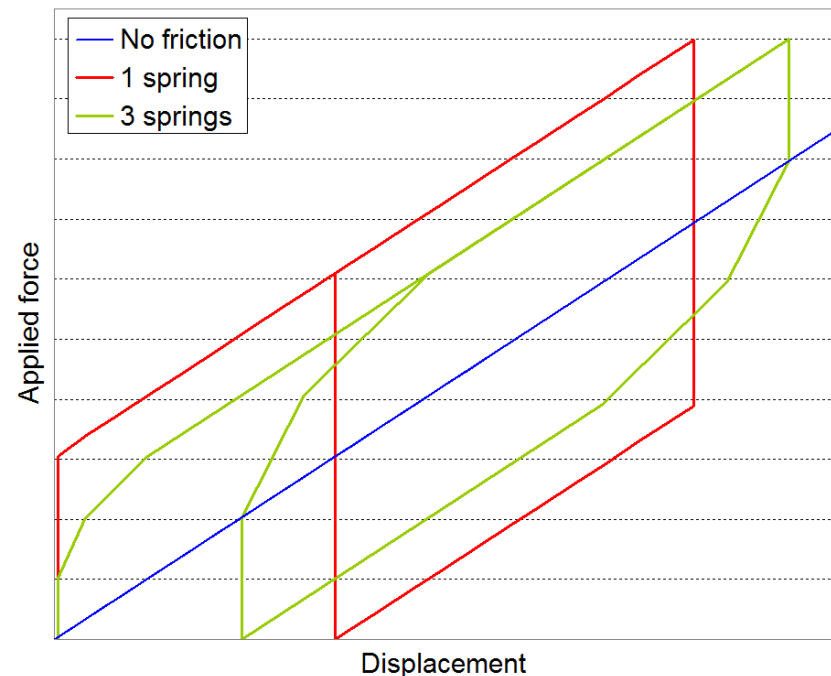
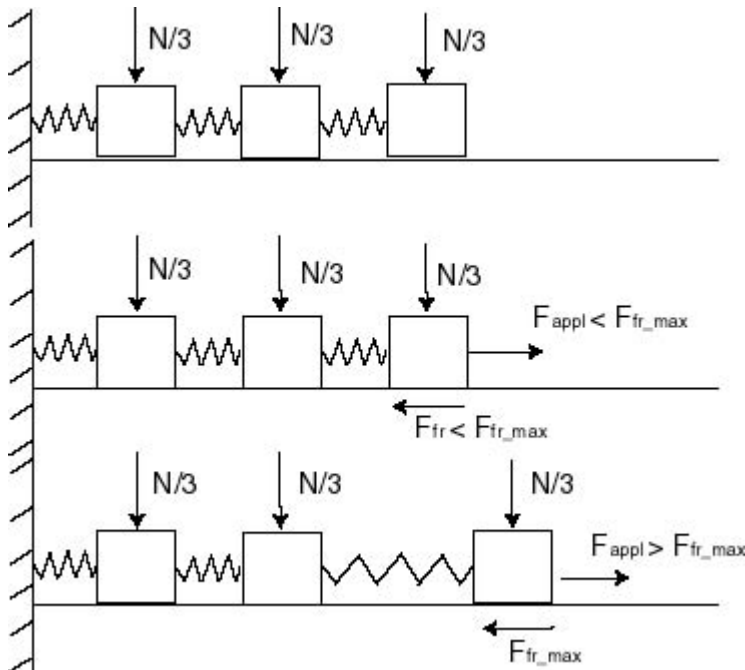



Frictional motion

- A real coil under the effect of Lorentz forces, can be analyzed as a series of springs.
 - If we cycle the forces, a frictional system is not completely reversible.

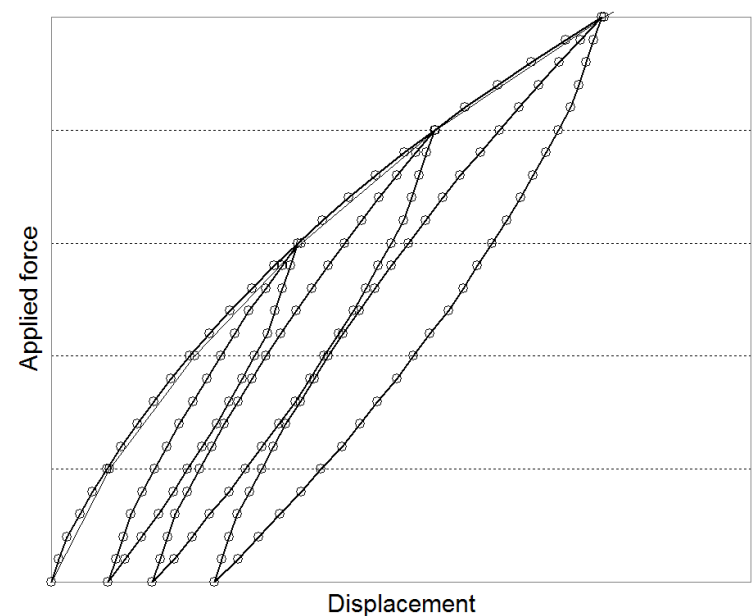
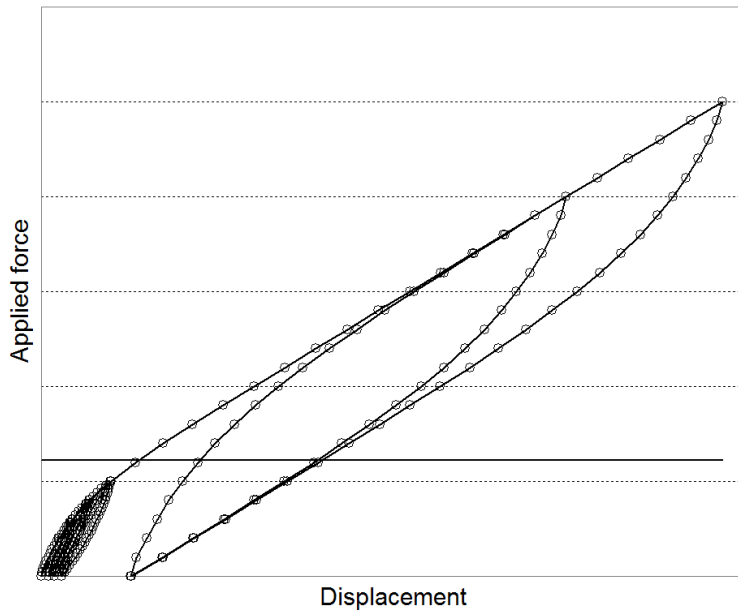
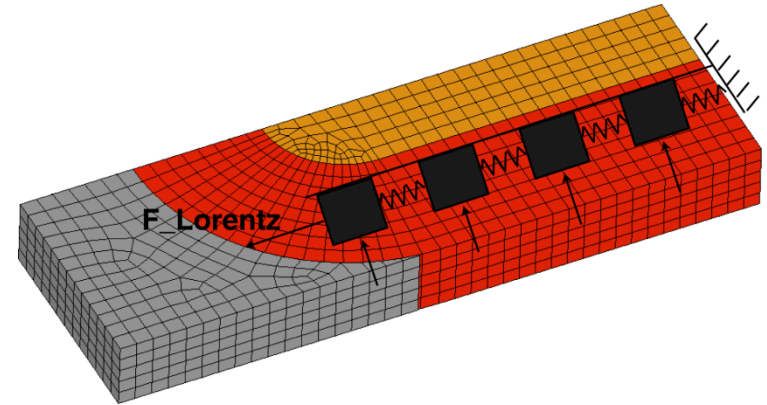



Frictional motion



- Strain measurements

- Increase of coil length as Lorentz forces are cycled
 - The axial Lorentz forces tend to pull the coil ends outwardly
 - After an excitation cycle, the coil does not return to its original length

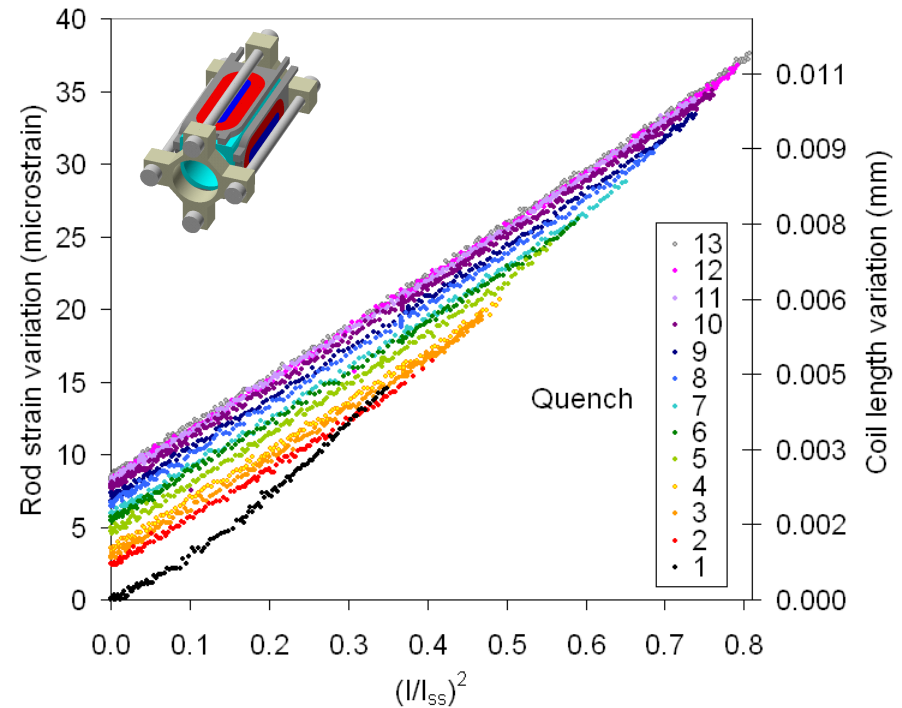
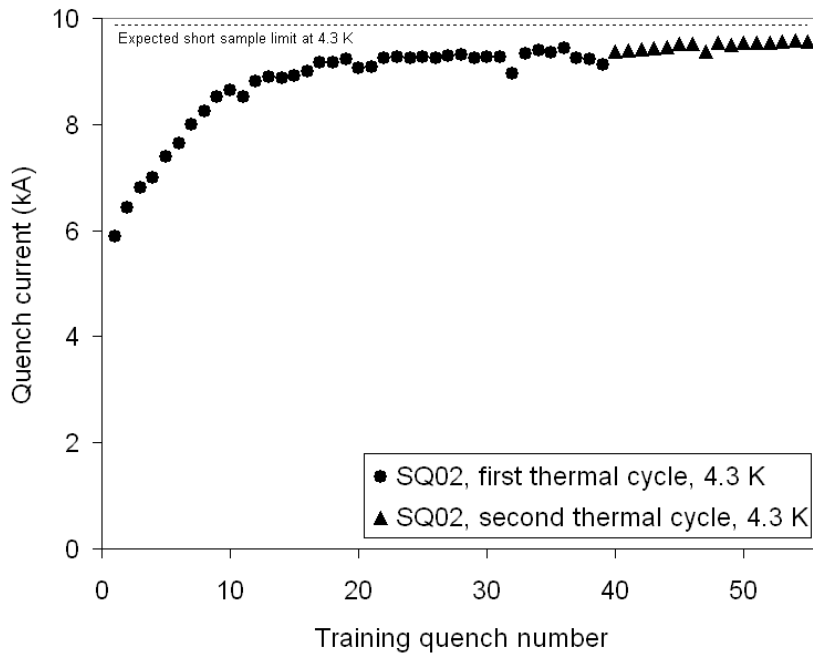



- Acoustic emissions measurements
 - AE are emitted during frictional sliding between two surfaces (cracks)
 - Kaiser effect
 - “During a sequence of cyclic loading, mechanical disturbances such as conductor motion and epoxy fracture appear only when the loading responsible for disturbances exceeds the maximum level achieved in the previous loading sequence.” [3]

H. Maeda, *et al.*, [4]

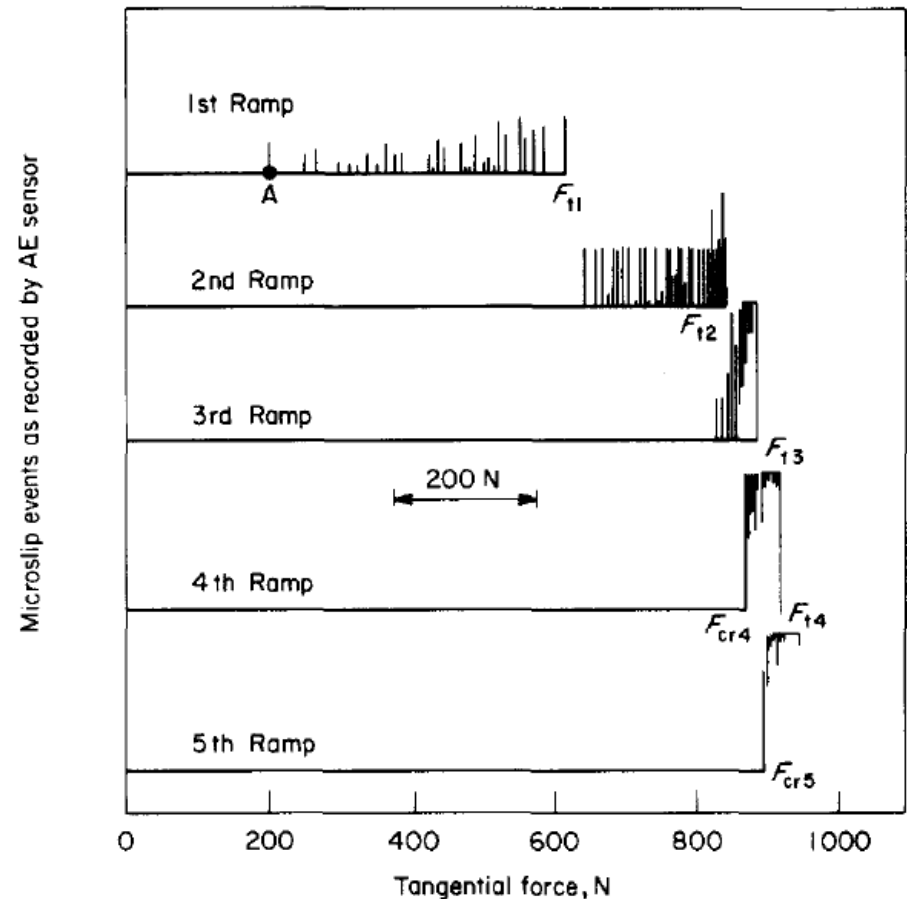



- How to prevent it?
 - Minimizing conductor motion
 - Hold the coil as tight as possible
 - Quality of the components
 - Smooth surfaces to minimize frictional energy
 - Epoxy impregnation
 - It glues the conductor
 - It “protects” the brittle superconductor (Nb_3Sn)
 - It increases the coil modulus
 - For the same force/stress applied, the displacement/strain is reduced
- Unfortunately epoxy impregnation presents a drawback
 - Epoxy failures



Epoxy failures

- Epoxy resin becomes brittle at low temperature
 - Micro-cracking or micro-fractures may occur
- The phenomenon is enhanced by the fact that the epoxy has an higher thermal contraction than the composite superconductor (to which it is glued)
 - After cool-down the resin is in tension
- A brittle material in tension may experience crack propagation.
 - When a crack propagated, the strain energy previously stored in the volume surrounding the crack is converted in heat.
- We can compute the order of magnitude of the energies released by epoxy cracking.

M. Wilson, [6]

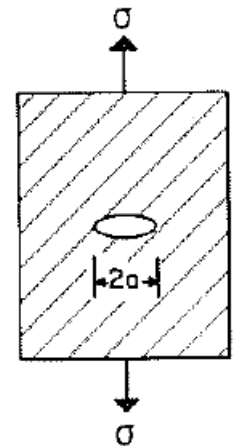



Epoxy failures



- A material under stress/strain stores a strain energy density [J/m³] given by (uniaxial case)

$$Q = \frac{1}{2} \frac{\sigma^2}{E} = \frac{E \varepsilon^2}{2}$$

where E is the elastic modulus [N/m²].

- After cool-down, considering the much higher modulus of the composite conductor, the strain in the epoxy can be expressed as

$$\varepsilon \sim \alpha_{\text{epoxy}} - \alpha_{\text{Cu}} \sim 8 \times 10^{-3}$$

where α is the integrated thermal contraction (from 293 K to 4.2 K).



Epoxy failures

- Assuming for the epoxy an elastic modulus of 5000 MPa, one gets a stored energy density of 1.6×10^5 J/m³, which is very high compared to the minimum quench energy density.
- To prevent or minimize this potential quench initiation phenomenon
 - fibrous reinforcement (fiberglass) are added to the epoxy to reduce cracks and thermal contraction;
 - volumes with only resin are minimized;
 - In general, epoxy is used where it is needed (Nb₃Sn magnets).
- A current question is how do we characterize the epoxy properties and what do we need?

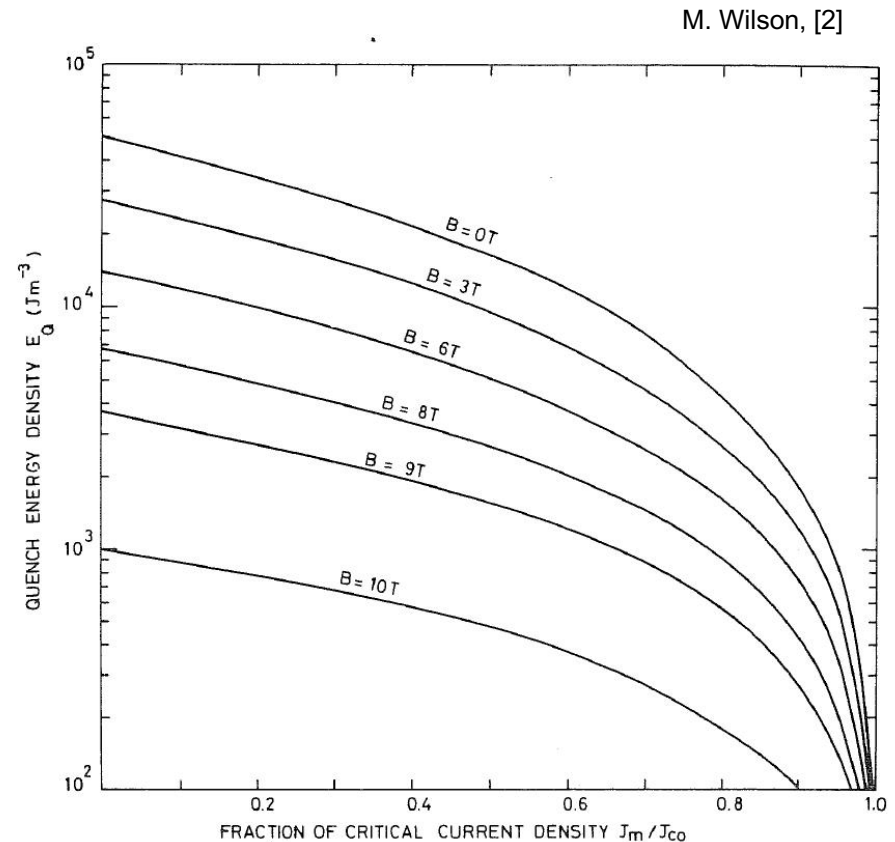



Case studies of quench performance Tevatron dipole magnets



- All magnets were measured under two different excitation cycles (different ramp rates).
- The average J_c measured on the cable is 1800 A/mm² at 5 T and 4.2 K. The average short sample current is 4600 A (nominal 4333 A).

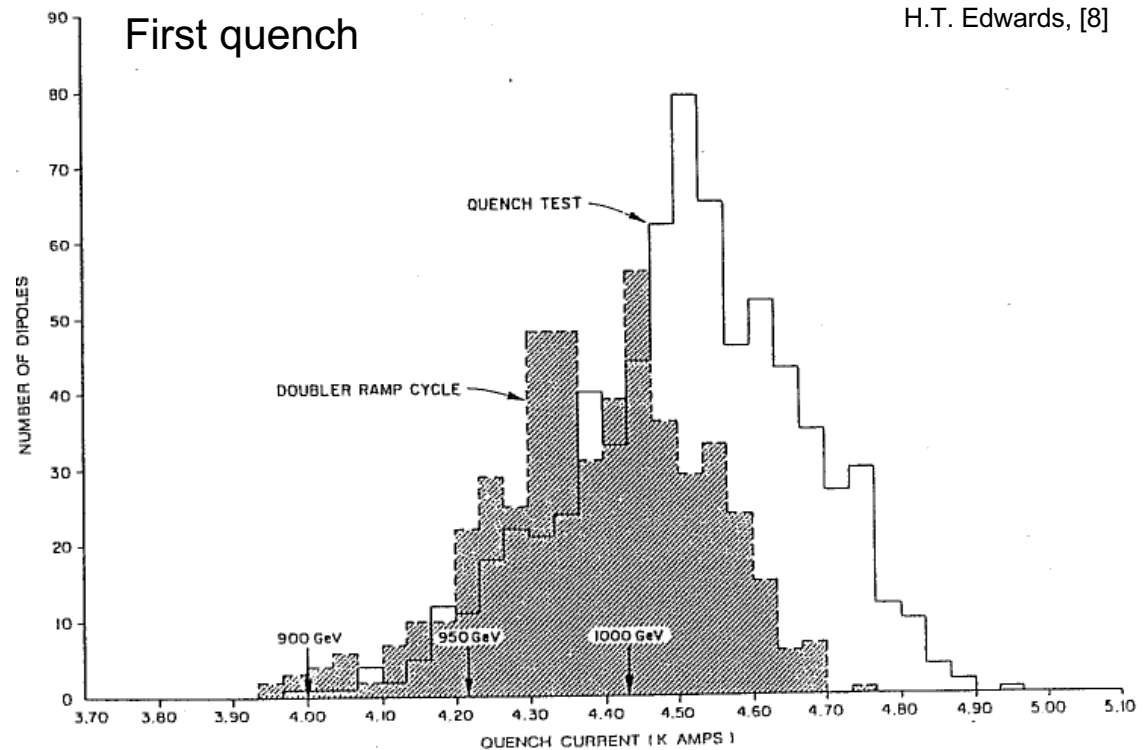
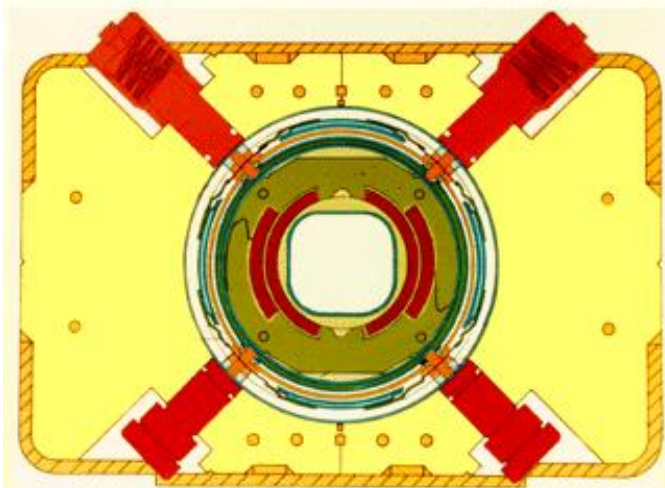



Case studies of quench performance HERA dipole magnets

- Training is negligible: maximum quench current reached after few quenches.

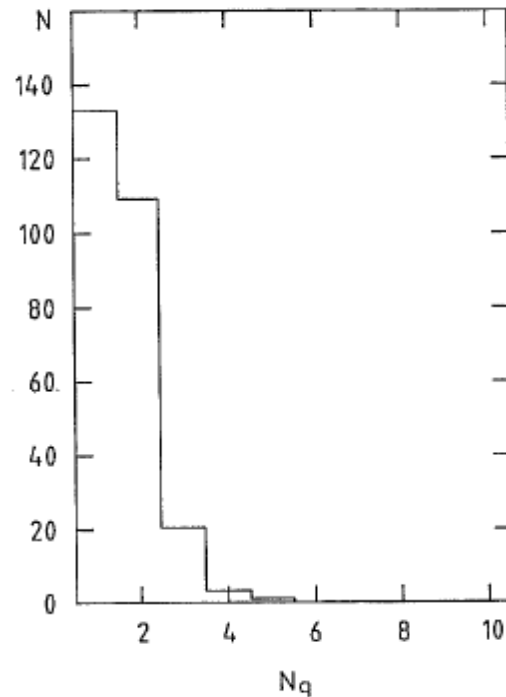
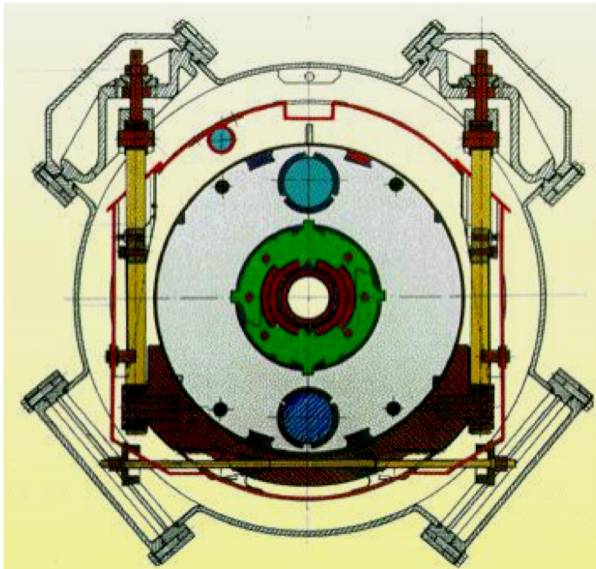

Fig. 36 Number of quenches to reach maximum quench current of HERA dipoles.

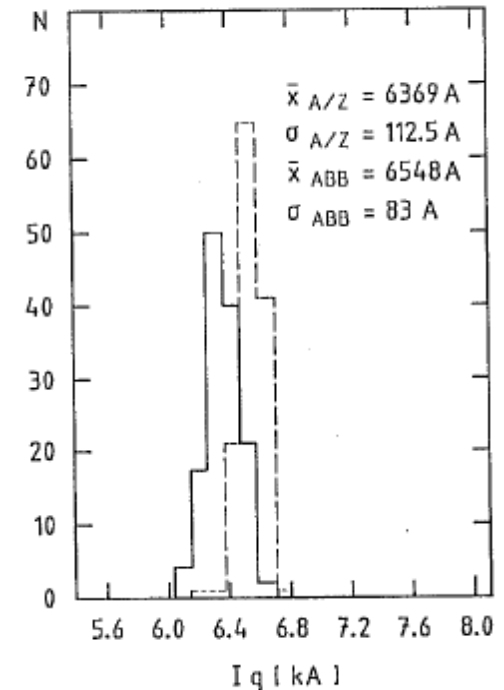

Fig. 37 Statistics of maximum quench current for German (ABB, dashed curve) and Italian (A/Z, solid curve) HERA dipoles.



Case studies of quench performance SSC dipole magnets



- Test results from 18, 50 mm aperture, SSC dipole prototypes [10]
 - No or very little training to 6600 A (operating current).
 - All the magnets tested reached a plateau current very close to the short sample current.

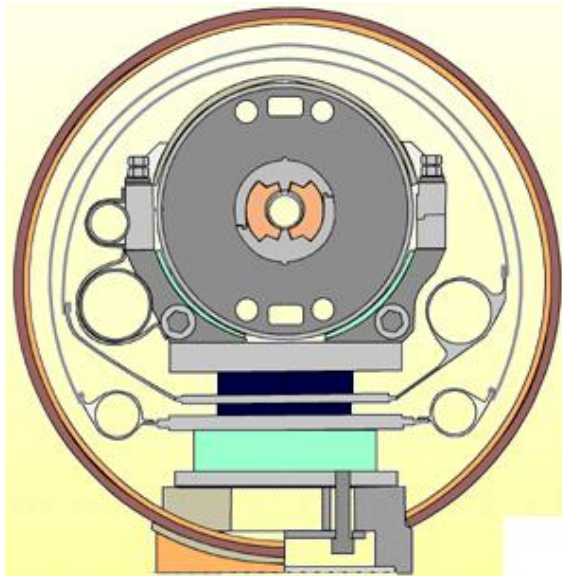

W. Nah, *et al.* [10]

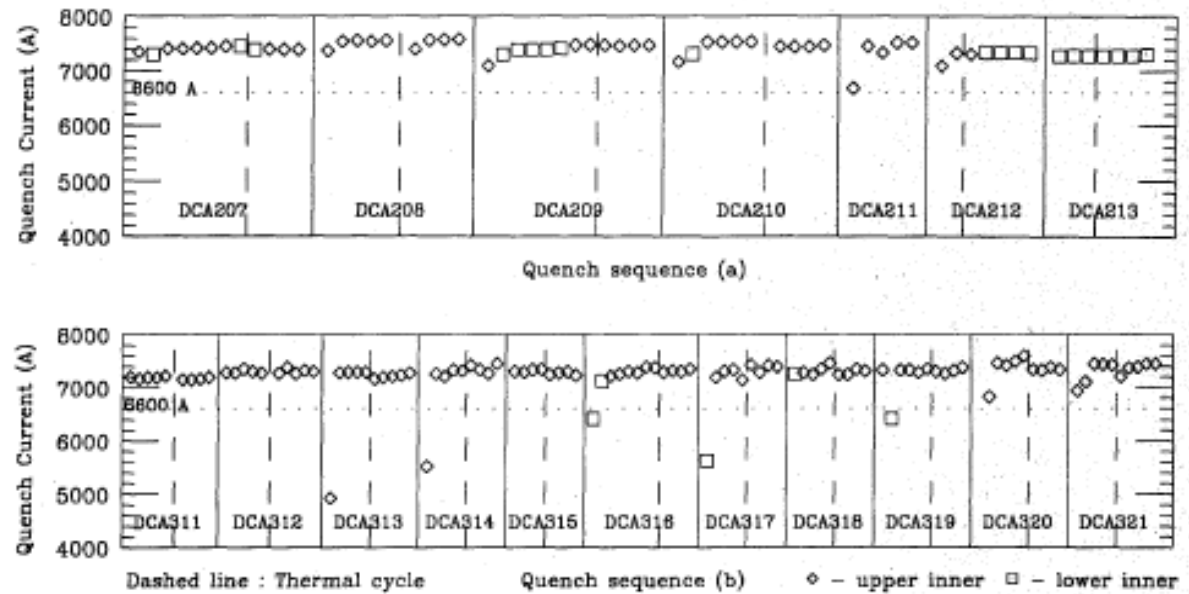



Case studies of quench performance RHIC dipole magnets

- Test results of the first 41 RHIC dipole magnets [11]
 - All the magnets exhibited minimum quench well above the RHIC operating current of 5000 A.

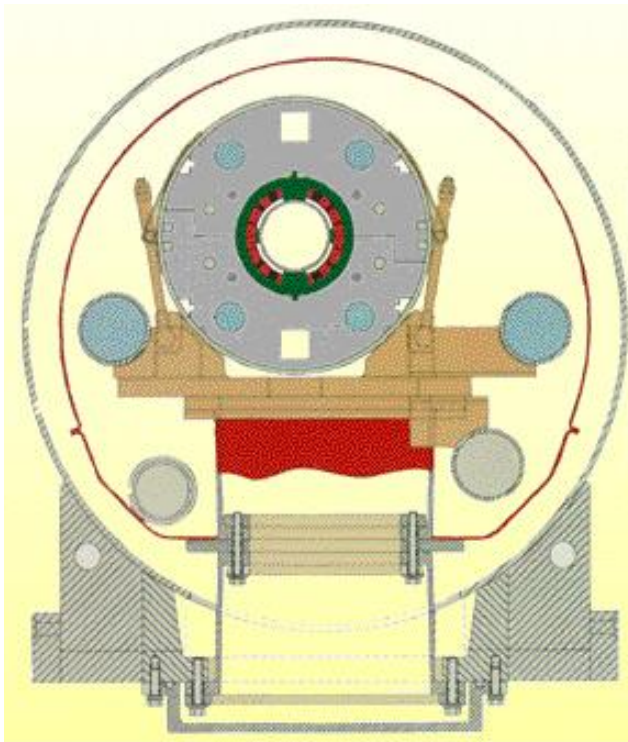

A. Green, *et al.* [11]

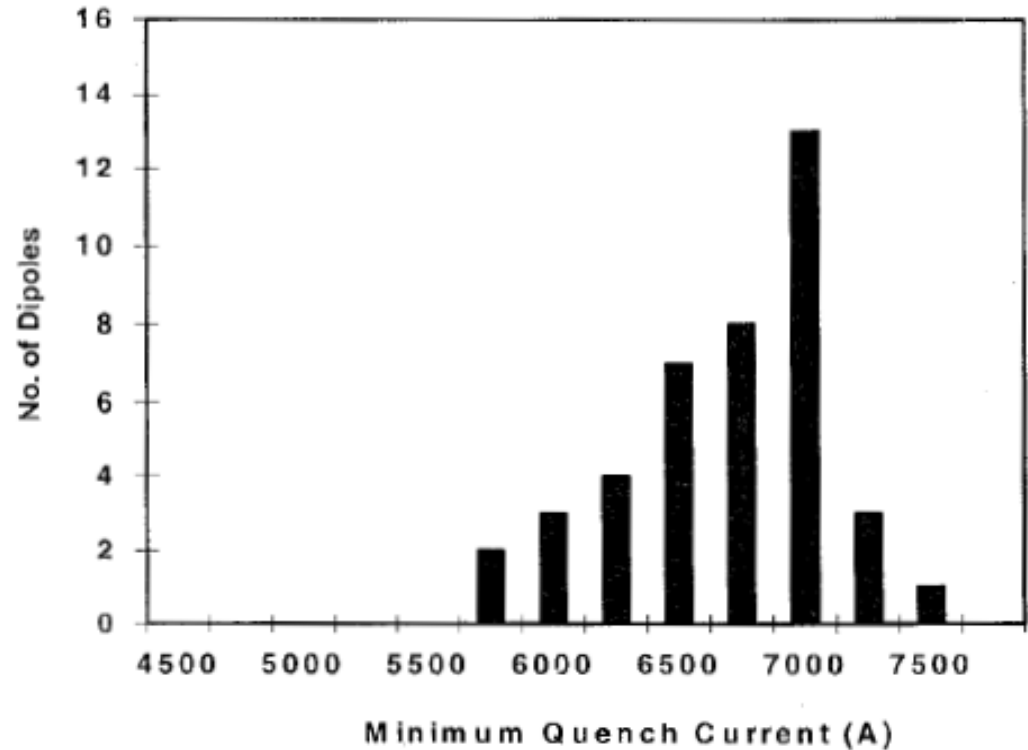



Case studies of quench performance LHC dipole magnets



- During the test of virgin magnets, in order to reach the nominal current of 11850 A (about 86% of I_{ss})
 - 0.6 quenches per magnet for Firm1, 1.2 for Firm2, and 1.0 for Firm3.
- Improved training expected during commissioning.

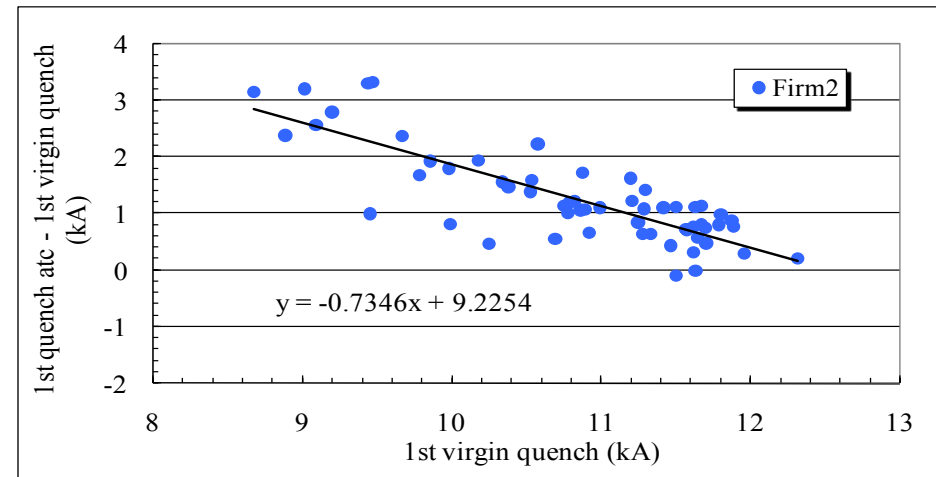
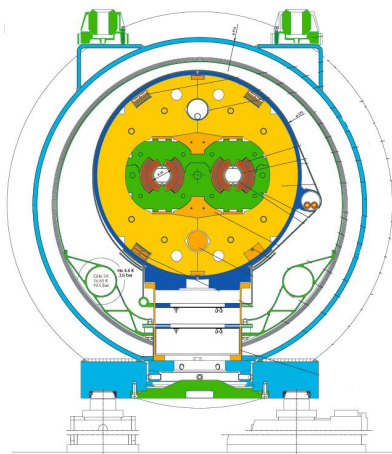
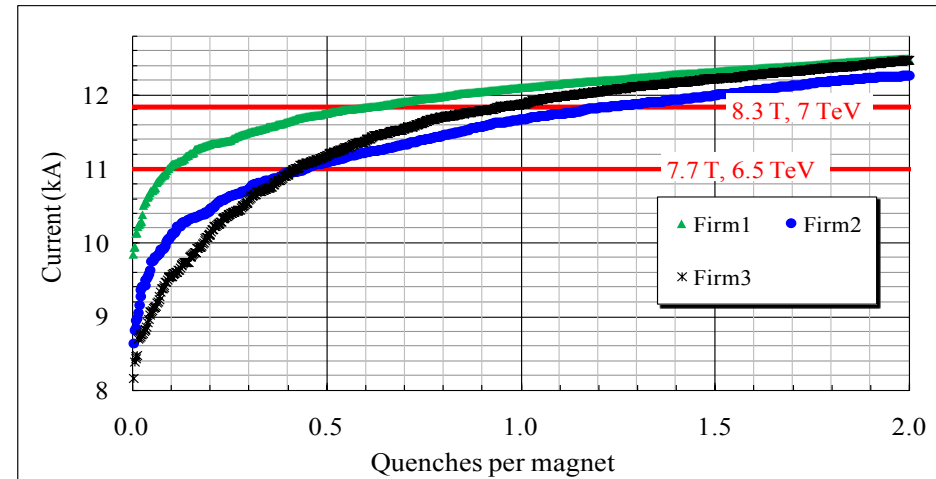



Overview of quench performances D20



- Conditioning
 - Magnet is cool-down at 1.8 K and then warm up to 4.4 K to improve training performance
- De-training
 - A progressive degradation occurred due to a damage to a splice.

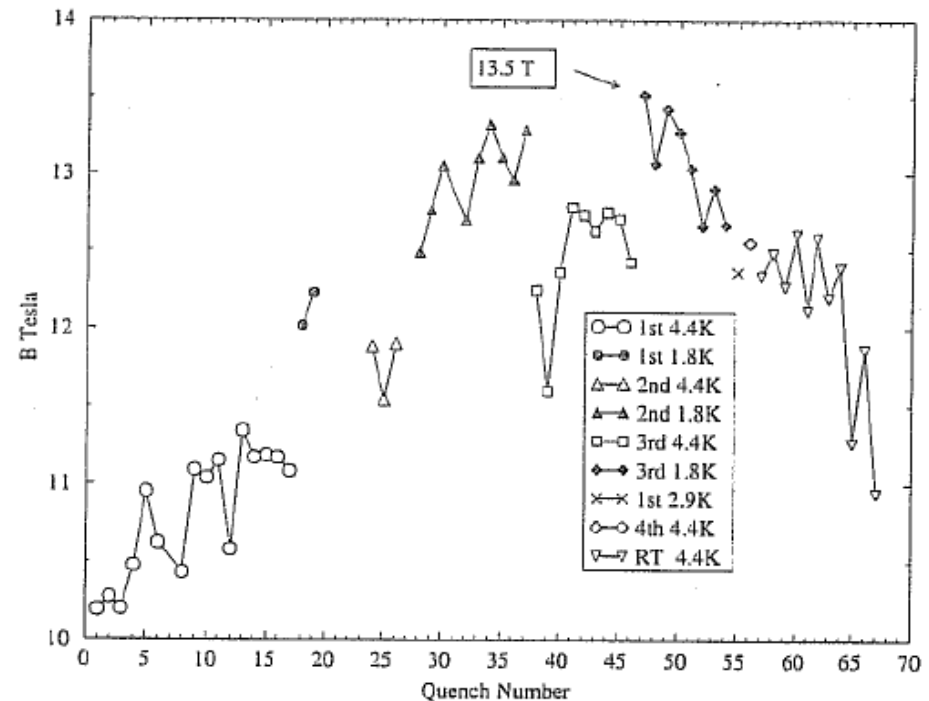
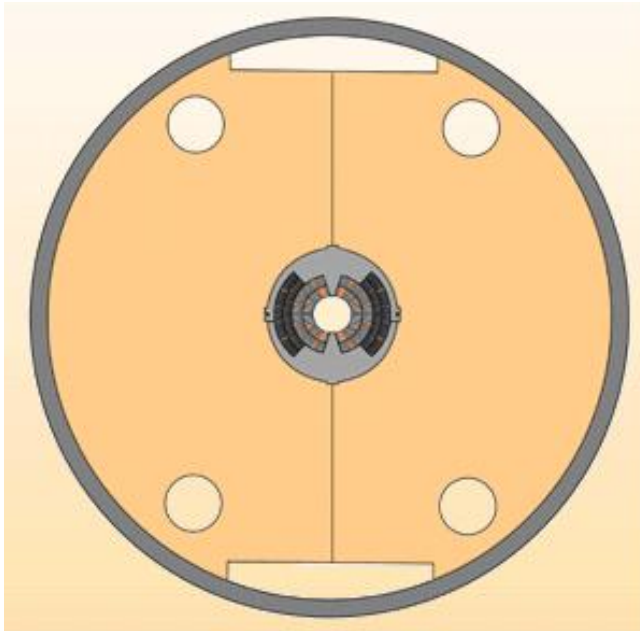



Case studies of quench performance

Tevatron Quad Corrector



- Aperture 3.00 inches
- Maximum gradient 0.633 T/cm
- Current ~1000 A Maximum ramp rate 50 A/sec
- Magnetic length 24 inches
- Overall length 30 inches
- Outside diameter 7.25 inches
- Integrated 12-pole harmonic < 15 units



Case studies of quench performance

Tevatron Quad Corrector

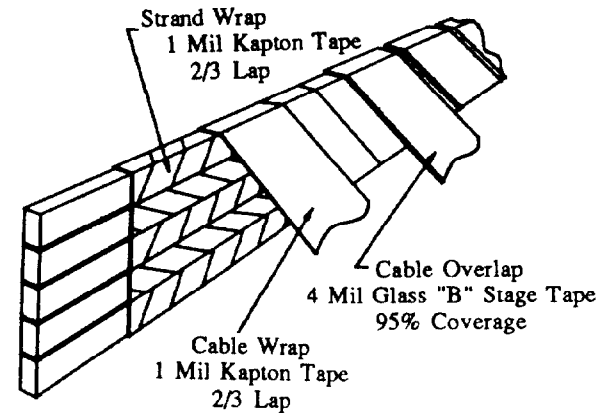
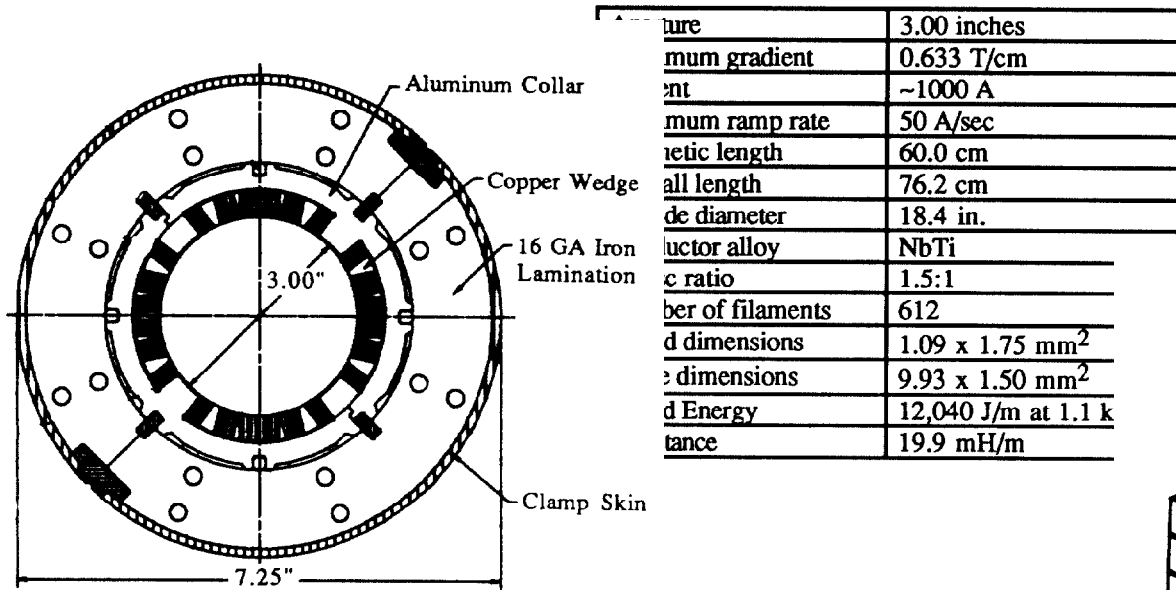



Case studies of quench performance Tevatron Quad Corrector

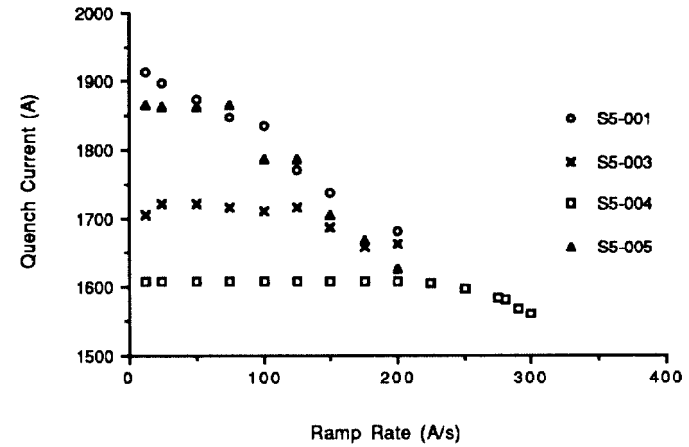
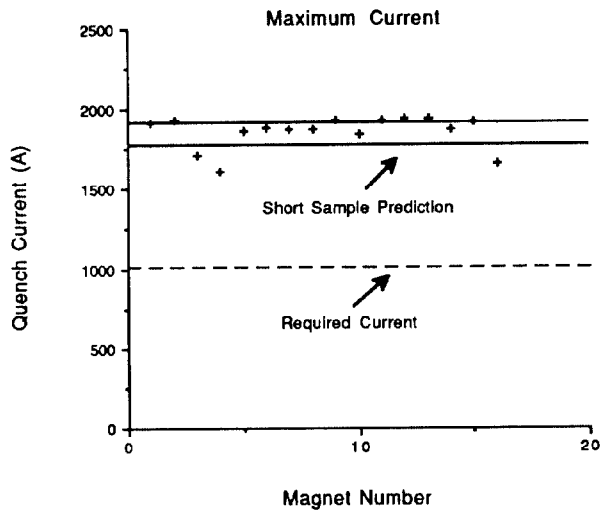

Plateau current of all the magnets

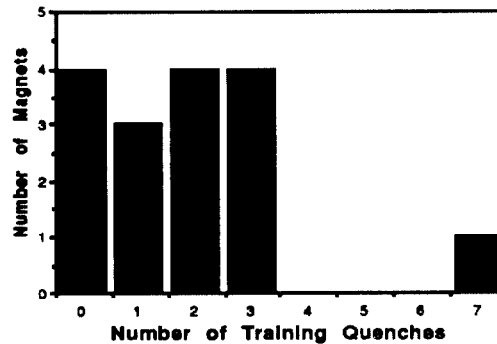

Training quenches to plateau



Summary



- The training phenomenon can be defined as
 - The occurrence of premature quenches
 - The progressive increase of quench current
- Both characteristics can be explained by frictional motion and/or epoxy fracture.
- Superconducting accelerator magnets usually operate with a sufficient current margin (with respect to short sample current), so that nominal current is reached with very few quenches.



References



- [1] H. Brechna and P. Turowsky, "Training and degradation phenomena in superconducting magnets", proceedings of the 6th International Conference on Magnet Technology, 1978. p. 597.
- [2] A. Tollestrup, "Care and training in superconducting magnets", IEEE Trans. Magn., Vol. MAG-17, No. 1, January 1981, p. 863-872.
- [3] O. Tsukamoto and Y. Iwasa, "Sources of acoustic emission in superconducting magnets", J. Appl. Phys. 54, 997 (1983).
- [4] Y. Iwasa, "Mechanical disturbances in superconducting magnets - A review", IEEE Trans. Magn., Vol. 28, No. 1, January 1992, p. 113-120.
- [5] H. Maeda, "The mechanism of frictional motion and its effects at 4.2 K in superconducting magnet winding models", Cryogenics 22, 287 (1982).
- [6] M. Wilson, "Superconducting magnets", Oxford UK: Clarendon Press, 1983.
- [7] A. Devred, "Quench origins", AIP Conference Proceedings 249, edited by M. Month and M. Dienes, 1992, p. 1309-1372.
- [8] H.T. Edwards, "The Tevatron energy doubler: a superconducting accelerator", Ann. Rev. Nucl. Part. Sci. 1985, 35: 605-60.
- [9] S. Wolff, "Superconducting magnet design", AIP Conference Proceedings 249, edited by M. Month and M. Dienes, 1992, p. 1160-1197.
- [10] W. Nah, et al., "Quench characteristics of 5-cm-aperture, 15-m-long SSC dipole magnet prototypes", IEEE Trans. Supercond., Vol. 3, Issue 1, Part 4, March 1993, p. 658 - 661.
- [11] A. Green, et al., "The magnet system of the Relativistic Heavy Ion Collider (RHIC)", IEEE Trans. Magn., Vol. 32, No. 4, July 1996, p. 2041-2046.
- [12] L. Rossi, "The LHC from construction to commissioning", FNAL seminar, 19 April 2007.