



# Unit 13

## Construction methods and support structures

Soren Prestemon and Steve Gourlay  
Lawrence Berkeley National Laboratory (LBNL)



# Outline



- Introduction
- Coil winding and curing
- Reaction of  $\text{Nb}_3\text{Sn}$  coils
- Vacuum impregnation of  $\text{Nb}_3\text{Sn}$  coils
- “React & Wind” approach
- Instrumentation and measurements
- Nb-Ti – Nb-Ti and  $\text{Nb}_3\text{Sn}$  – Nb-Ti splices
- Final assembly
- Practical examples
- Summary



We have a spool of insulated cable. Now what?

- Fabrication steps for Nb-Ti and Nb<sub>3</sub>Sn coils
- Assembly into a magnet structure.



# Coil Winding and Curing



- The coil is the **most critical** component of a superconducting magnet.
- Cross-sectional **accuracy** of few hundredths of millimeters (few mils) over up to 15 m length must be reached for field quality requirements.
- The coils are manufactured in a clean environment. The cable must be free of any metallic chips that could damage the conductor or the insulation (shorts). No overhead cranes!
- Coil is fabricated with **laminated tooling**: very accurate laminations can be fabricated at low cost and assembled in long length.



L. Rossi, [1]



# Coil winding and curing

## Winding tooling

- A continuous length of insulated cable sufficient for one coil is wound on a **spool**.
- Then, from the spool, the cable is wound around a **pole** mounted on a steel **mandrel**. The mandrel is made of laminations mounted on a beam.
- Winding starts from the pole turn of the inner layer after preparing the coil ramp for the outer layer.
- The cable is maintained in **tension** (200 N)

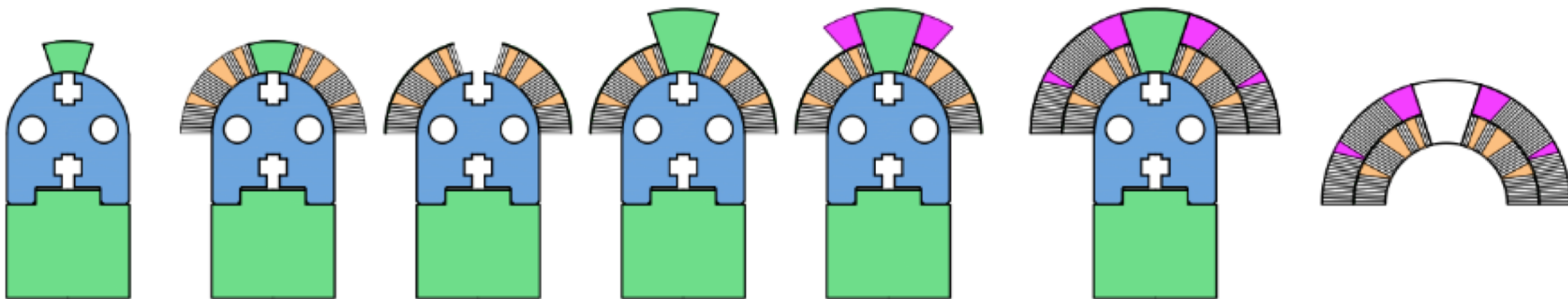



# Coil winding and curing

## Winding machines



- For short models, a **rotating mandrel** is used.

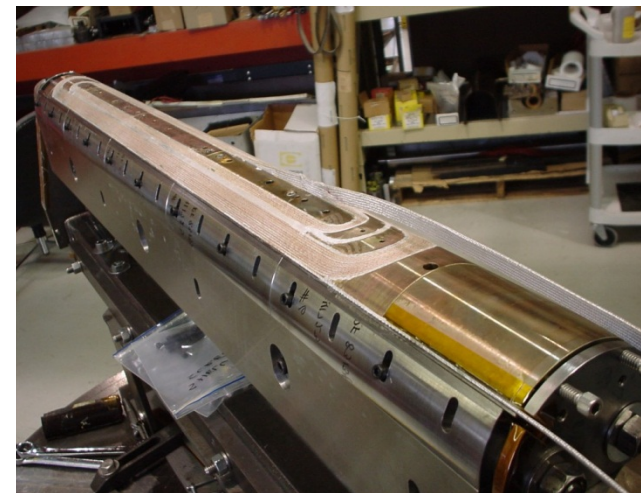
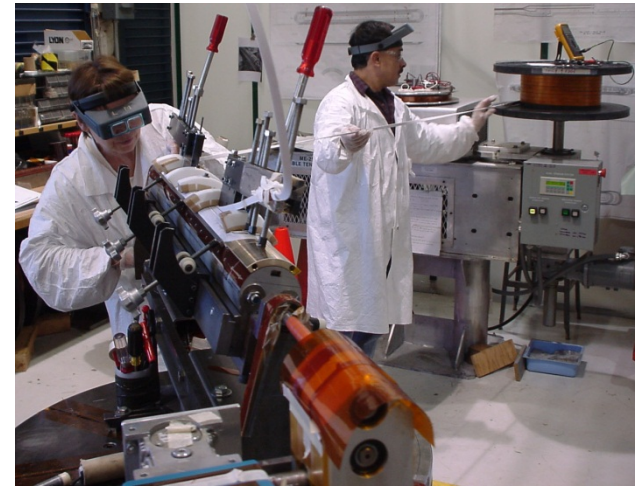
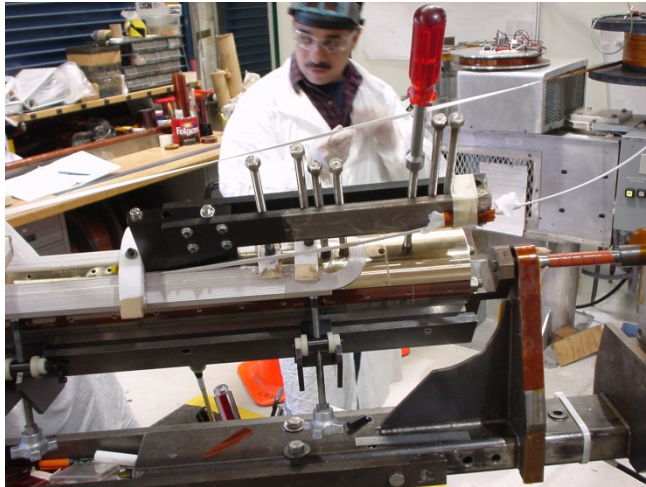



# Coil winding and curing

## Winding machines



- For large production of long coils, coil winding is done with **automated winding machines**.
- The cable spool, mounted on a **motor driven cart**, moves around the mandrel.
- As an alternative, the mandrel moves back and forth with respect to a spool fixed to a frame.
- The conductor must be **clamped** in the straight sections before winding the ends.

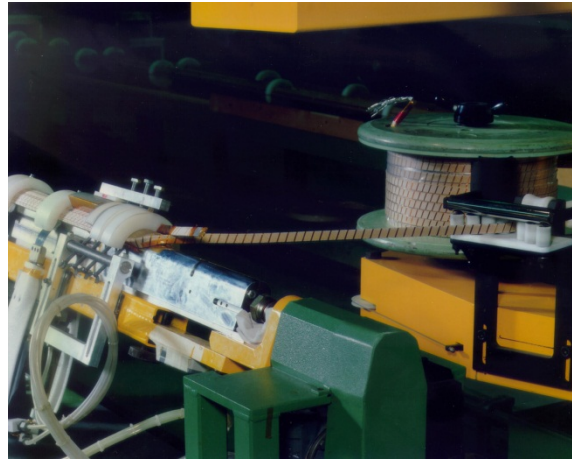

L. Rossi, [1]





# Coil winding and curing Ends



- In the **end region**, it is more difficult to constrain the turn which is bent over the narrow edge while moving around the mandrel.
- To improve the mechanical stability of the ends (and to reduce the peak field), spacers are precisely designed, using the constant **perimeter approach**.
  - The two narrow edges of the turn in the ends follow curves of equal lengths.
- In Nb-Ti magnets, end spacers are produced by 5-axis machining of **epoxy impregnated fiberglass**. Remaining voids are then filled by injection of loaded resins. (End parts are generally not perfect!)
- **Note: an expensive learning experience**

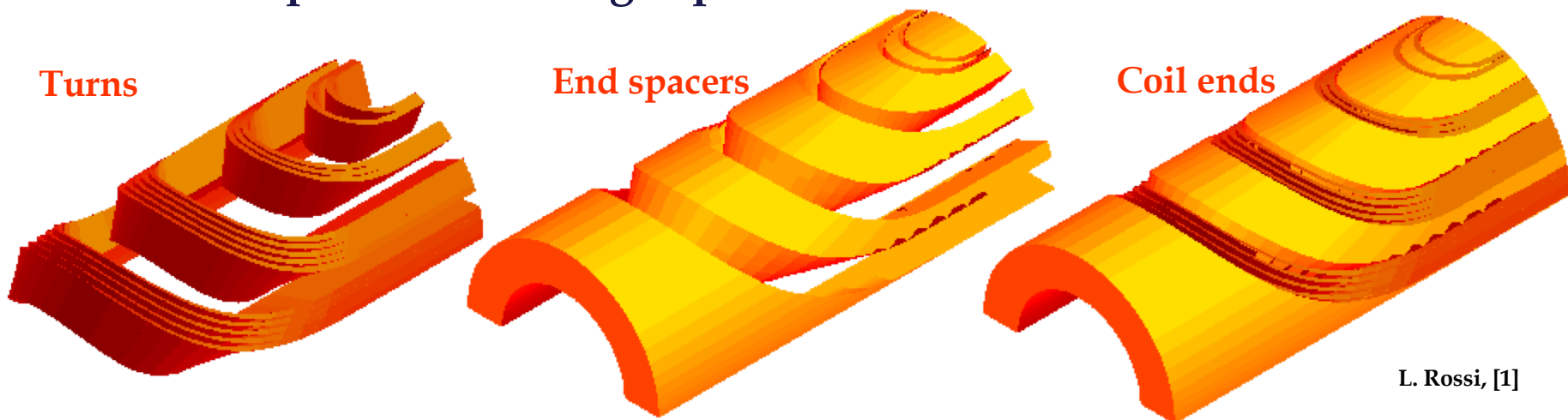

L. Rossi, [1]





# Coil winding and curing Ends



- In  $\text{Nb}_3\text{Sn}$  magnets, end spacers are produced by 5-axis machining of **aluminum bronze** or **stainless steel**.





# Coil winding and curing Ends

- There is a **minimum bending radius**, which depends on the cable dimensions.
  - Is there a general rule? No, but usually the bending radius is 10-15 times the cable thickness.
  - The cable must be constantly monitored during winding.
- If the bending radius is too small
  - **De-cabling** during winding;
  - Strands **“pop-out”**.
- There is no difference in minimum bending radius between Nb-Ti and Nb<sub>3</sub>Sn, if the cable is reacted after winding (“wind-and-react technique”).
- If the cable is reacted before winding (“react-and-wind” technique), a much larger bending radius is required.

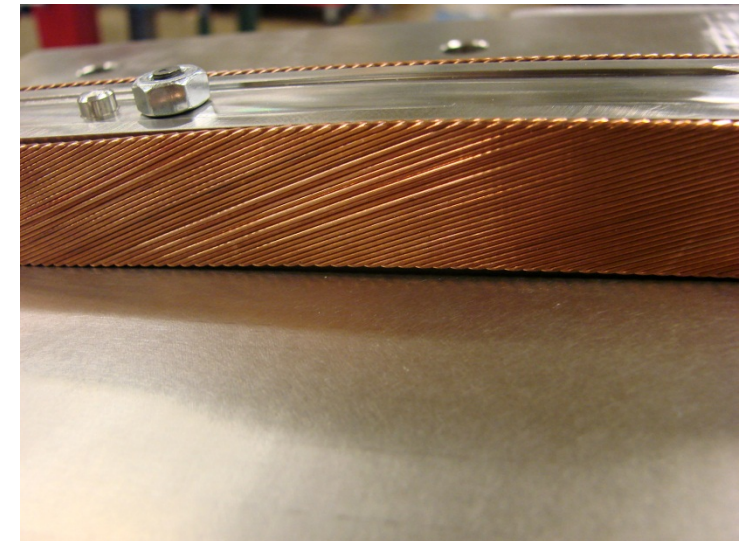
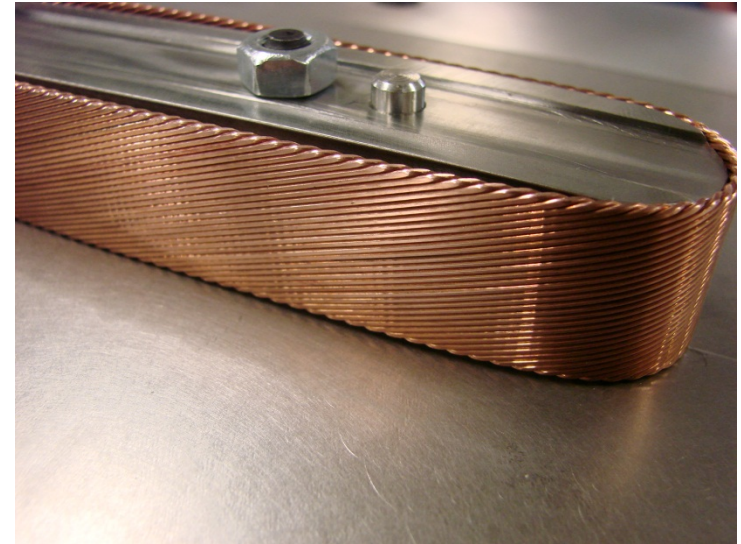



# Coil winding and curing

## Nb-Ti coil curing



- The aim of the **curing** operation is to:
  - Glue the turns together in order to facilitating coil **handling** during magnet assembly and define the mechanical **dimensions** of the coils.
    - For the LHC, coil dimensions must respect a tolerance of  $\pm 0.05$  mm, with the average value having  $\pm 0.03$  mm.
- While still lying on the mandrels, coils are placed in the **curing mold** equipped with a heating system, and compressed in curing press.
- Nb-Ti coils are cured up to  $190 \pm 3$  °C under a maximum pressure of 80-90 MPa (LHC main dipoles). The high temperature **activates the resin** present on the 3rd insulation layer.

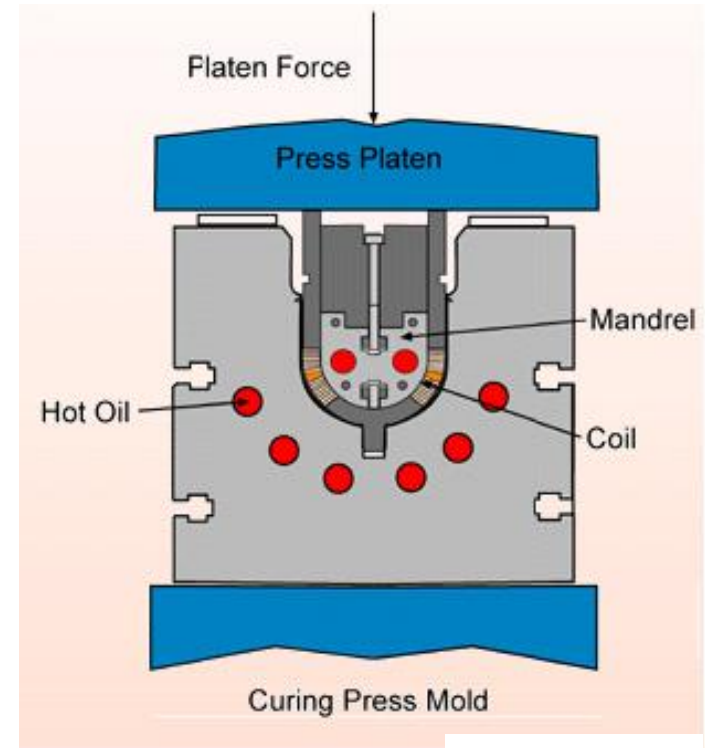

MJB Plus, Inc., [2]

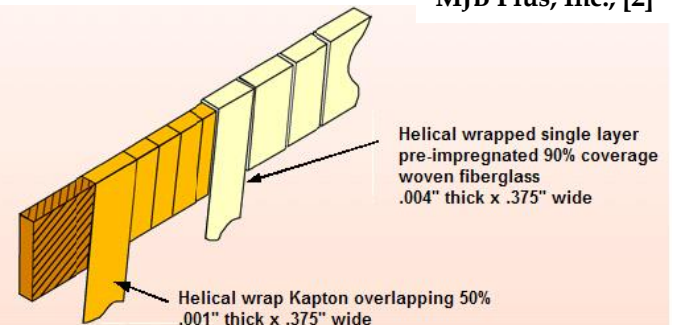



# Coil winding and curing

## Nb<sub>3</sub>Sn coil curing



- Similarly to Nb-Ti coils, in **Nb<sub>3</sub>Sn coils** curing is done to set the coil size for reaction, as well as allow the coils to be easily handled, facilitating insertion into the reaction fixture without damage.
- After winding, cable insulation is injected with **ceramic binder**. Then coils are cured at 150° C for 30 minutes, subjected to an azimuthal pressure of approximately 5 to 35 MPa.

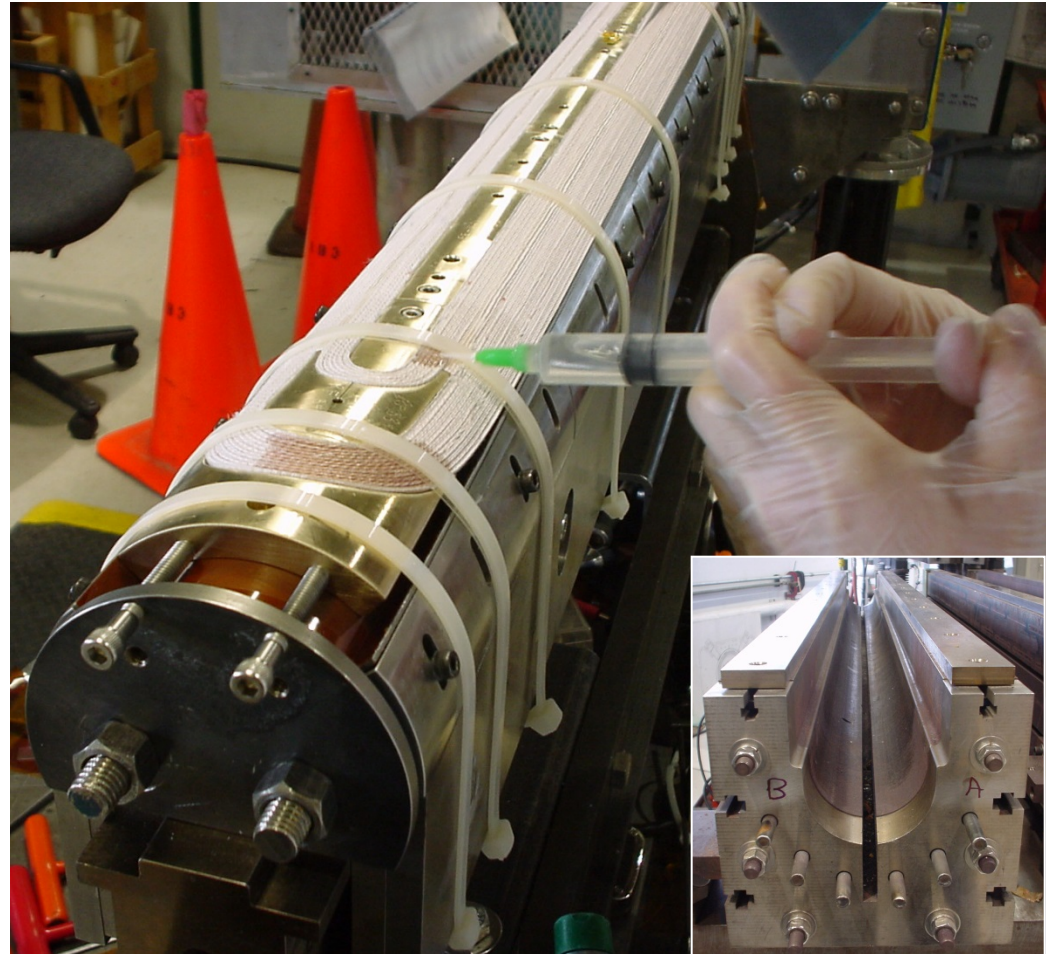



# Coil winding and curing

## Nb<sub>3</sub>Sn coil curing

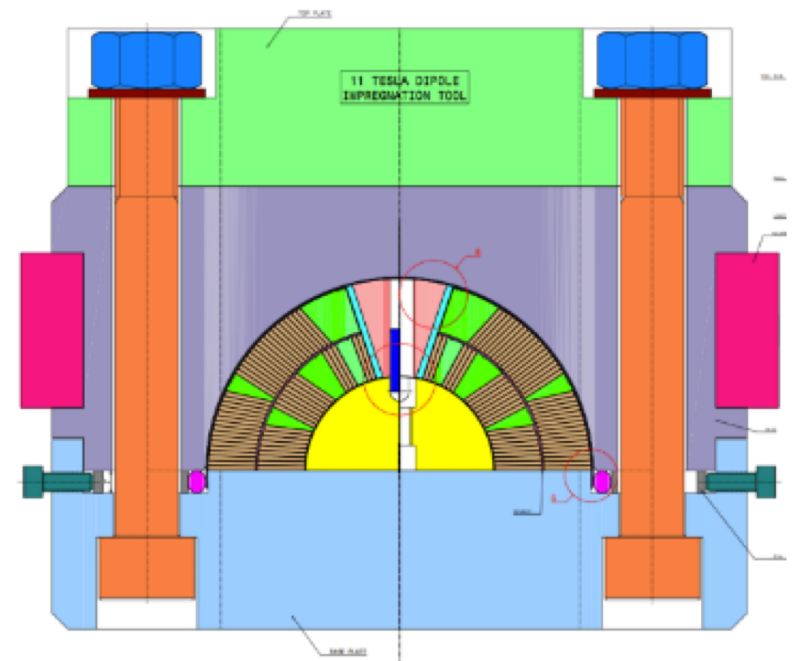



# Reaction of Nb<sub>3</sub>Sn coils



- During the “**reaction**” process, the CuSn or Sn and Nb are heated to about 650-700 °C in vacuum or inert gas (argon) atmosphere, and the Sn diffuses into Nb and reacts **to form Nb<sub>3</sub>Sn**.
- A cable of Nb<sub>3</sub>Sn is **brittle**, thus it cannot be bent to a small radius.
- In the “**Wind & React**” approach, the coil is wound un-reacted: then the entire coil undergoes the reaction process.
- The reaction is characterized by three temperature steps.
- The required temperature homogeneity is about  $\pm 3$  °C.

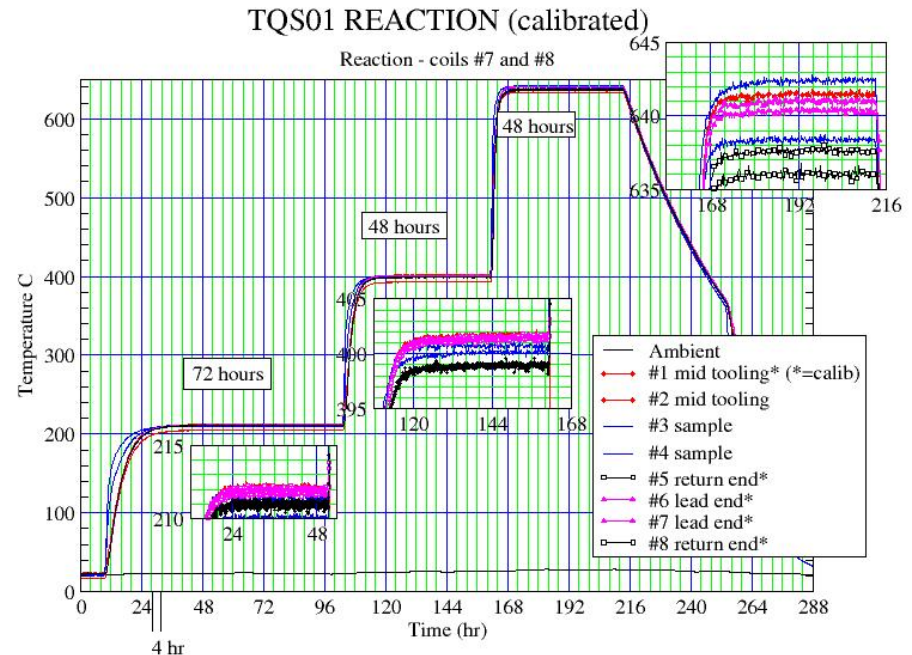



# Reaction of Nb<sub>3</sub>Sn coils



- Coils are clamped in a **reaction fixture** made of stainless steel mold blocks.
  - The pressure on the coil is minimal to reduce risk of degradation.
- Layers of fiberglass, MICA, stainless steel are placed between coil and mold blocks.

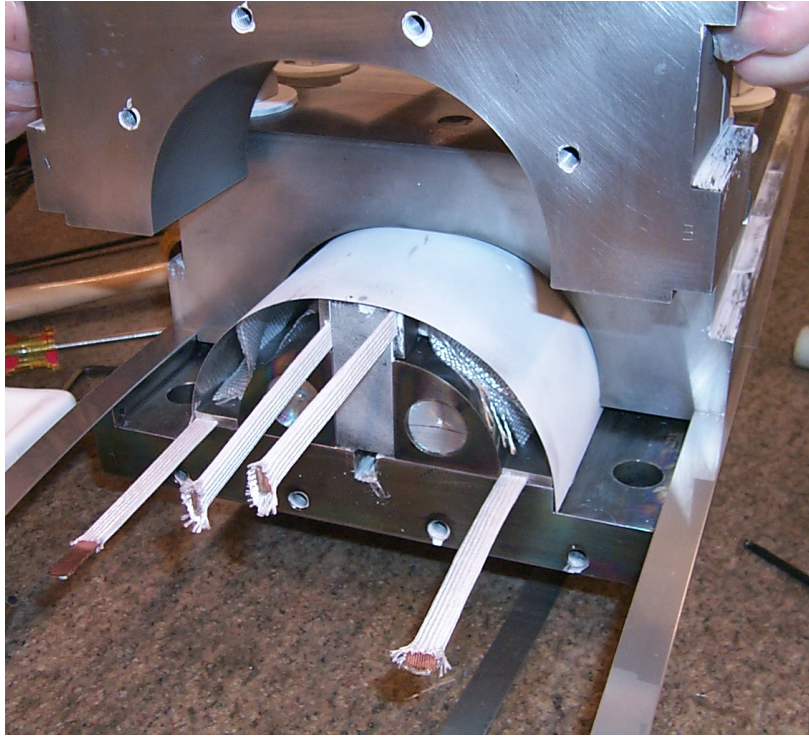



# Reaction of Nb<sub>3</sub>Sn coils



- Reaction fixture is placed in the oven and argon gas flow connected.
- The argon flows in the reaction fixture in contact with the conductor and fills the oven (welded).

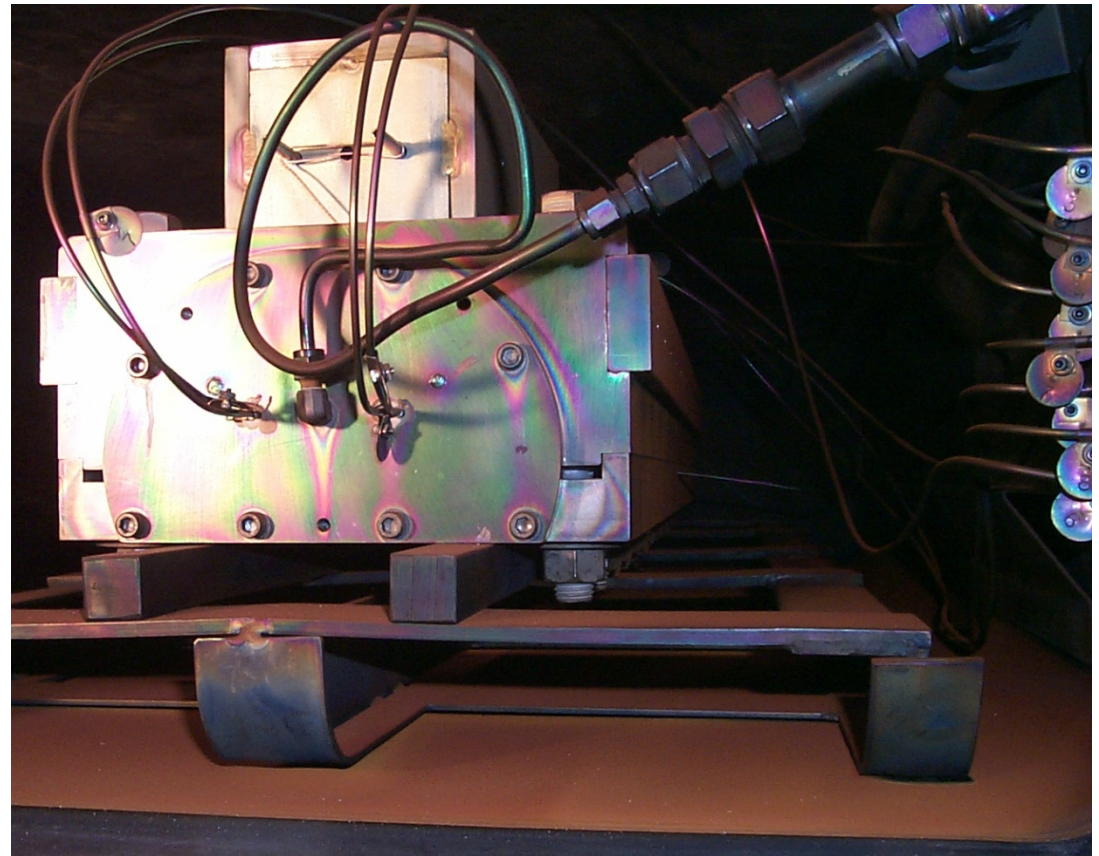
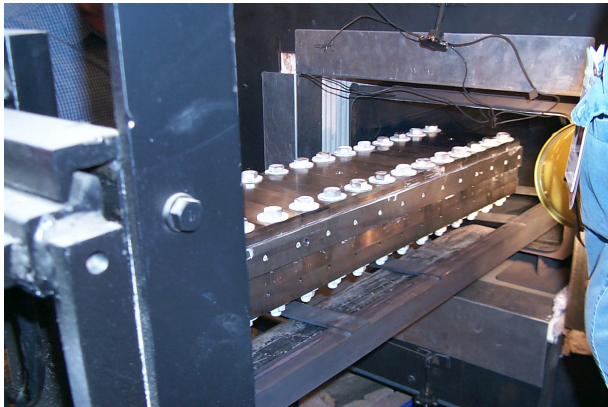





# Reaction of Nb<sub>3</sub>Sn coils





# Vacuum Impregnation

- For  $\text{Nb}_3\text{Sn}$  coils, impregnation is mandatory due to the brittleness of the superconductor.
- Nb-Ti coils (in general) are not potted and probably should not be. Generally has a bad outcome.
  - Low temperature margin of Nb-Ti points toward a desire for helium contact (porous insulation) with the conductor - more stable.
- Downside of epoxy is that due to thermal and mechanical stresses, it can crack, releasing energy and causing quench.
  - A problem for both  $\text{Nb}_3\text{Sn}$  and Nb-Ti but more so for Nb-Ti.

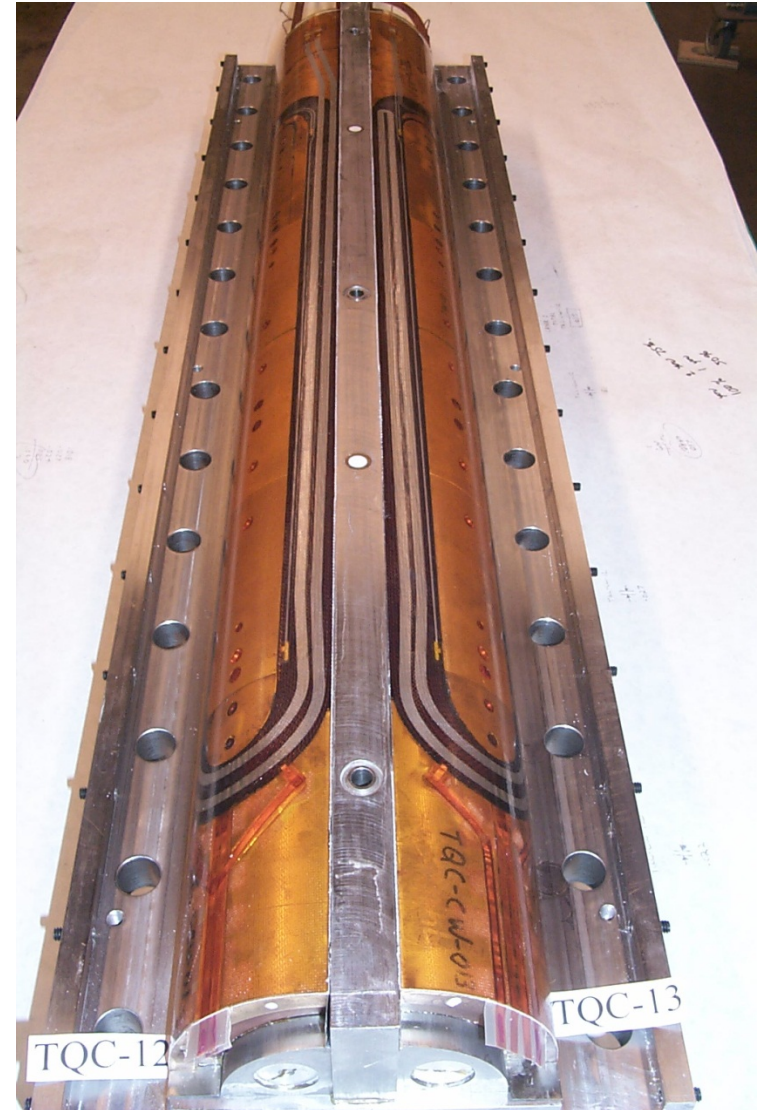



# Vacuum impregnation of Nb<sub>3</sub>Sn coils

- After reaction, Nb<sub>3</sub>Sn coil are **vacuum impregnated** (potted) with epoxy.
  - Resin creates a solid block, thus distributing the stress.
- Coil is placed in a **fixture** (potting fixture) in tight contact with the winding in order to minimize voids.
- The fixture is inserted in a **vacuum tank** and evacuated.

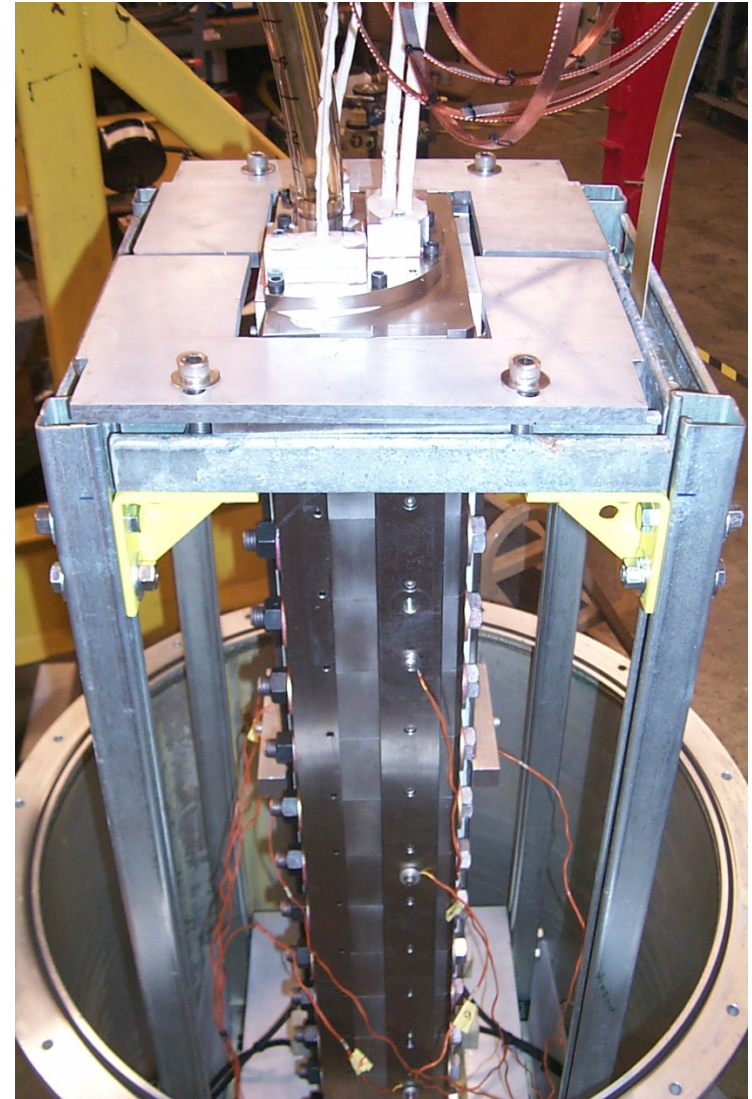
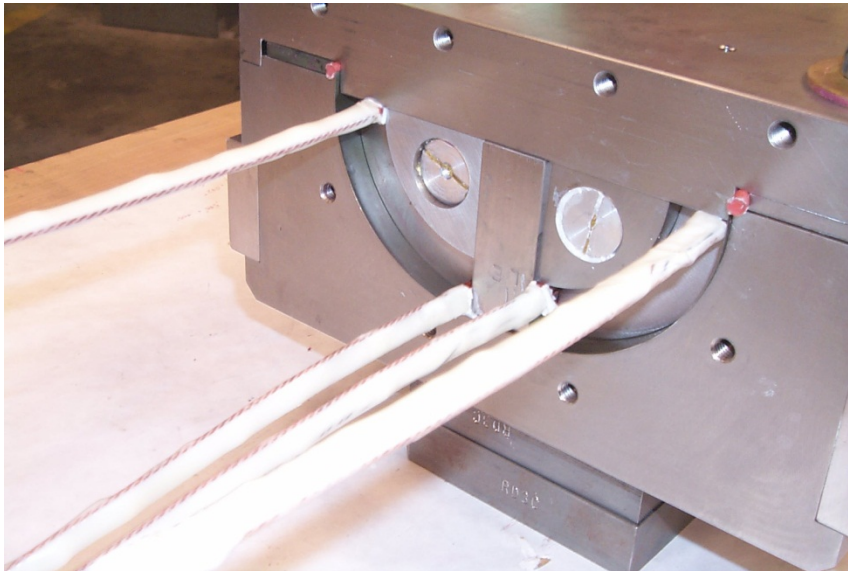



# Vacuum impregnation of Nb<sub>3</sub>Sn coils



- Reservoirs are connected to the fixture.
- Epoxy has high viscosity at room temperature. At about 60 °C, when it has **low viscosity**, atmospheric pressure is applied to drive the epoxy inside the mould.
  - Fixture must be leak tight
- Then, the further increase of temperature **cures the epoxy** which becomes solid.

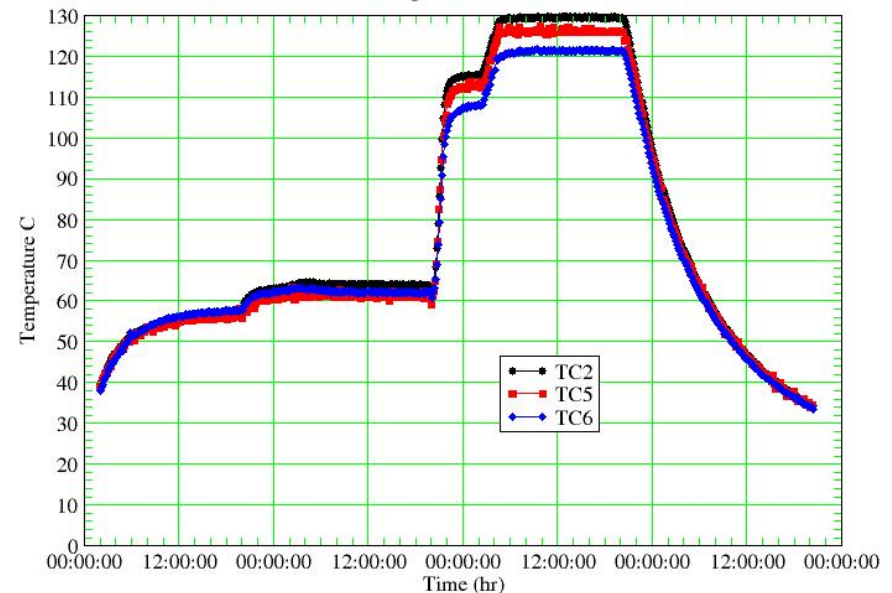
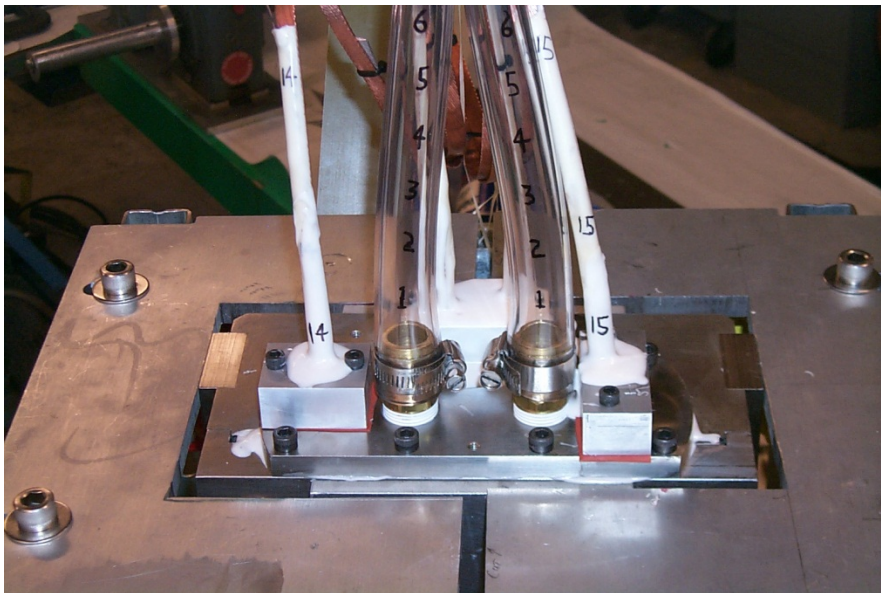



# Vacuum impregnation of Nb<sub>3</sub>Sn coils

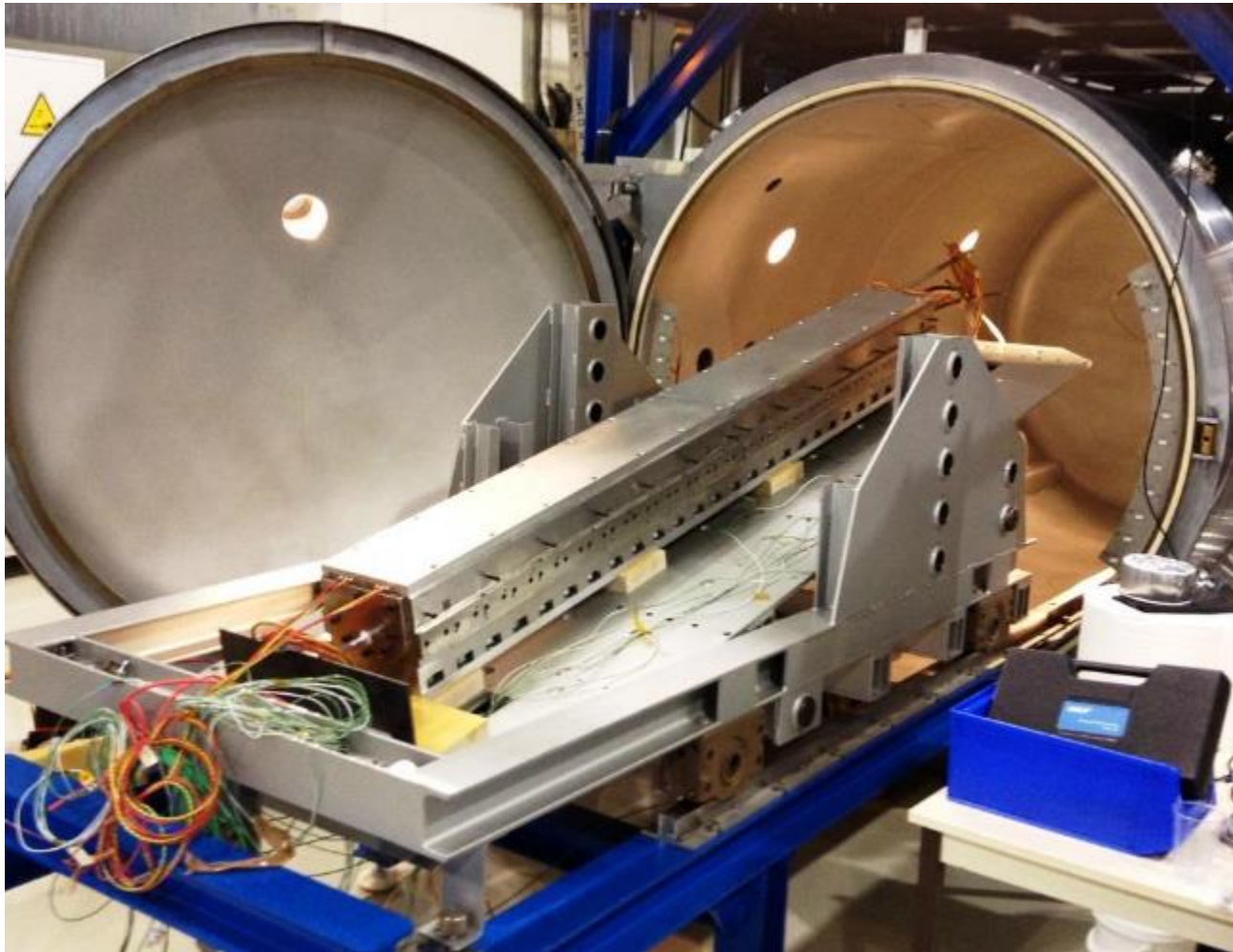



# Overview of Nb<sub>3</sub>Sn coil fabrication stages

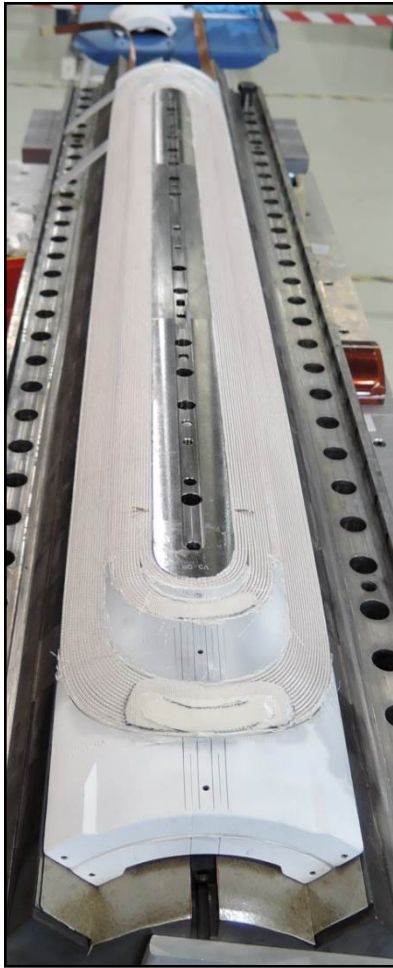

**After winding/curing**



**After reaction**



**After impregnation**



# Overview of Nb<sub>3</sub>Sn coil fabrication stages



**After winding/curing**

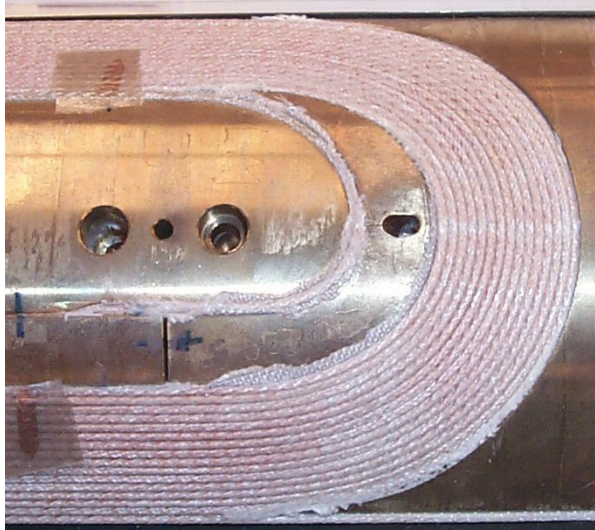

**After reaction**

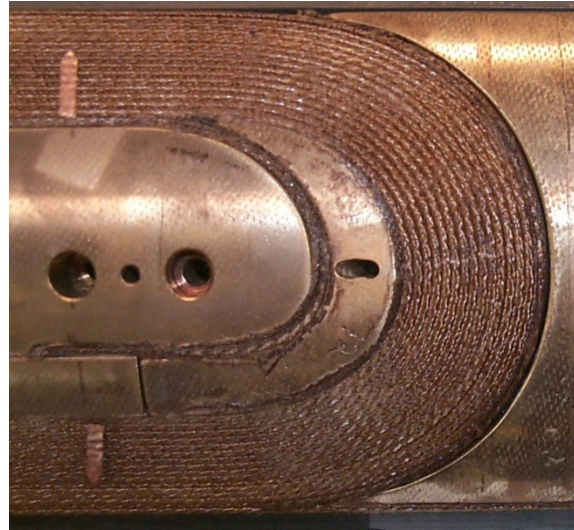

**After impregnation**

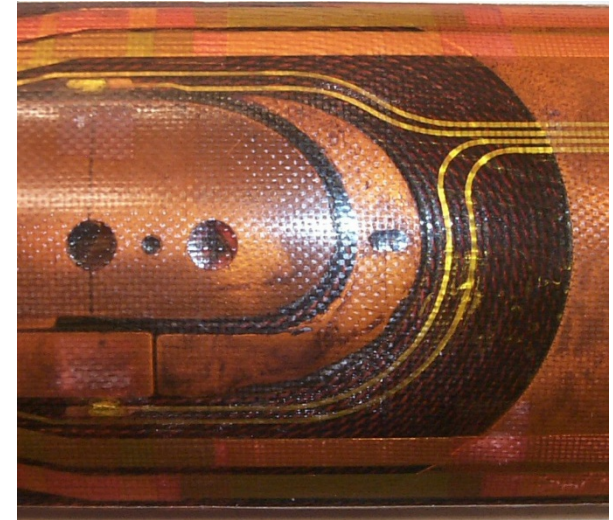



# “React & Wind” approach



- An alternative construction process for  $\text{Nb}_3\text{Sn}$  coils is “**React & Wind**”.
  - First react the conductor and second wind the coil
- On the one hand, since the conductor is brittle, small bending radius and complex end geometries (like in  $\cos\theta$  magnets) are **not allowed**.
- On the other hand, the process may look attractive for long magnets

“In the “Wind & React” approach, the integrated build-up of differential thermal expansion of various materials during the high temperature heat treatment may result in large accumulated strain in the ends of the magnets. Magnets with complex end geometries are more prone to degradation/damage due to this large local strain. Since the integral build-up is proportional to length, this issue becomes more critical in “Wind & React” as magnets get longer” [5].





# “React & Wind” approach

- Conductor is **reacted on a spool** with large radius.
- Coil geometry must be simple – no sharp bends
  - **Common coil design** is a suitable design due to the large bending radius in the ends
- Strain is minimized during winding.

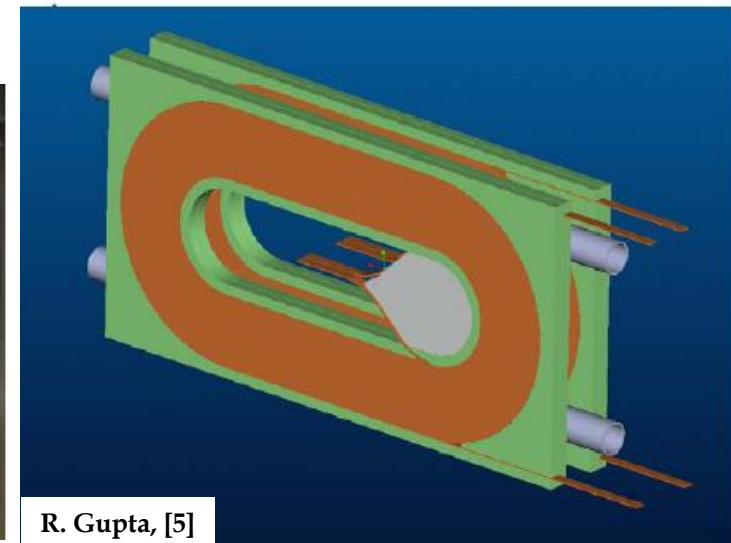
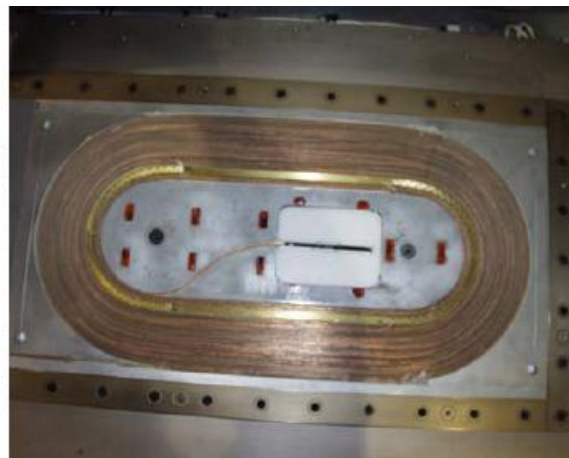
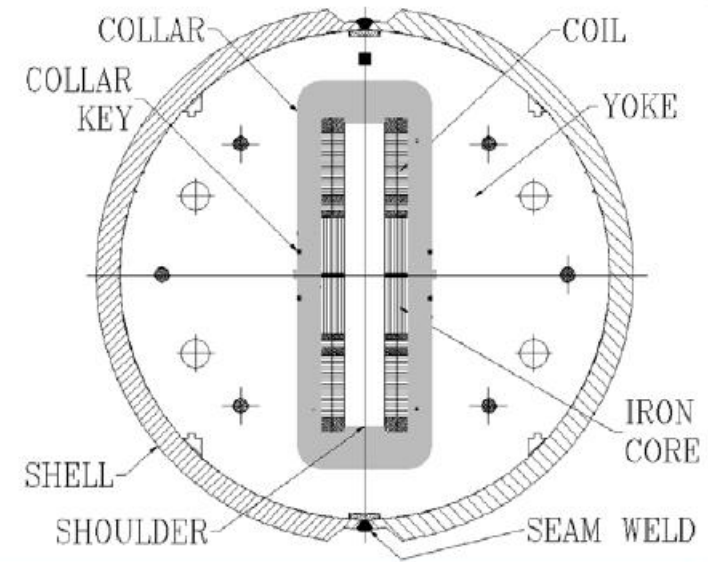

R. Gupta, [5]



- Quench heaters
  - When a quench occurs, quench heaters **raise the temperature** of the entire coil, bringing it to the normal state. By dissipating the stored energy in the whole coil volume, the peak temperature after a quench is minimized.





- Spot heaters
  - A diagnostic technique to intentionally generate a quench in order to measure parameters important for magnet protection - quench velocities, peak temperature, and voltages as a function of current and field.

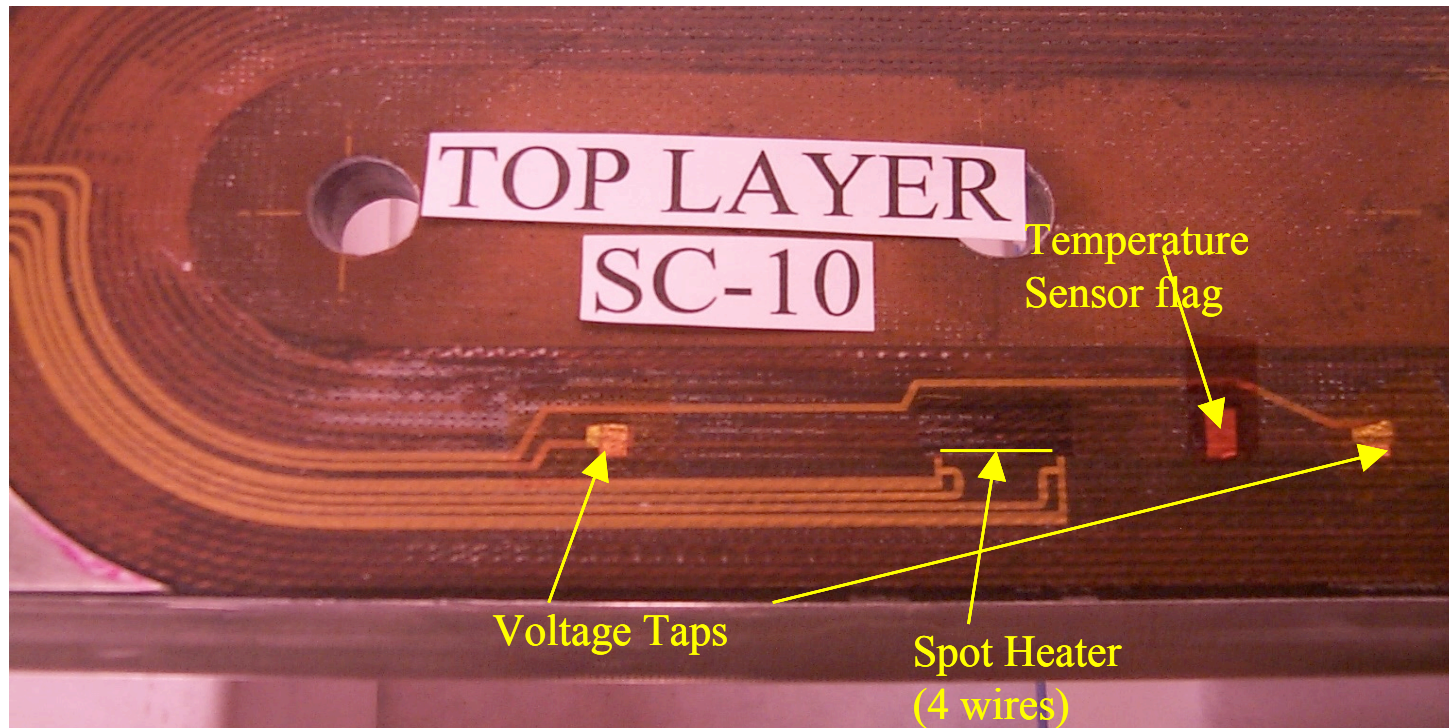



- Voltage taps
  - By providing a **measurement of the voltage** across a conductor segment, they allow monitoring in which turn/location a quench occurred, and how it propagated along the turn and from turn to turn. Considered necessary for R&D but only used as necessary in production magnets. Sometimes does more harm than good.

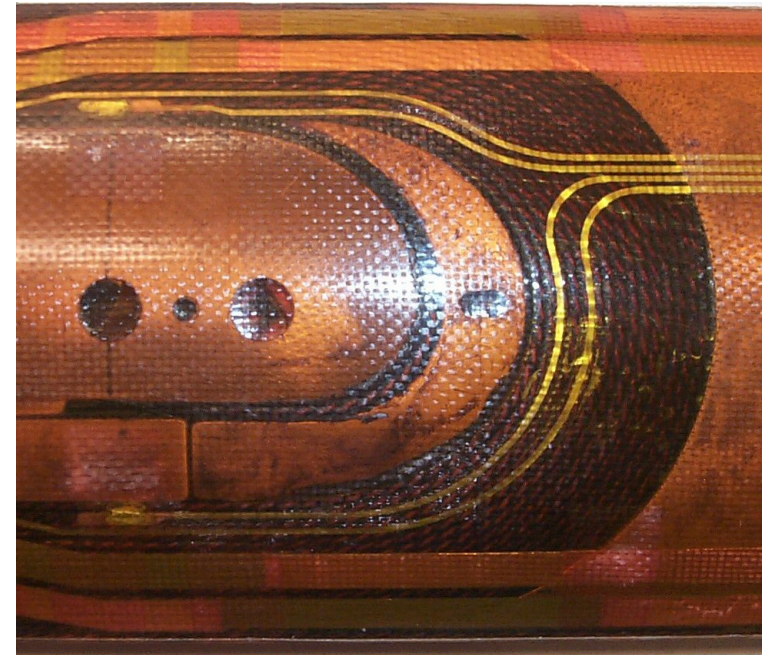
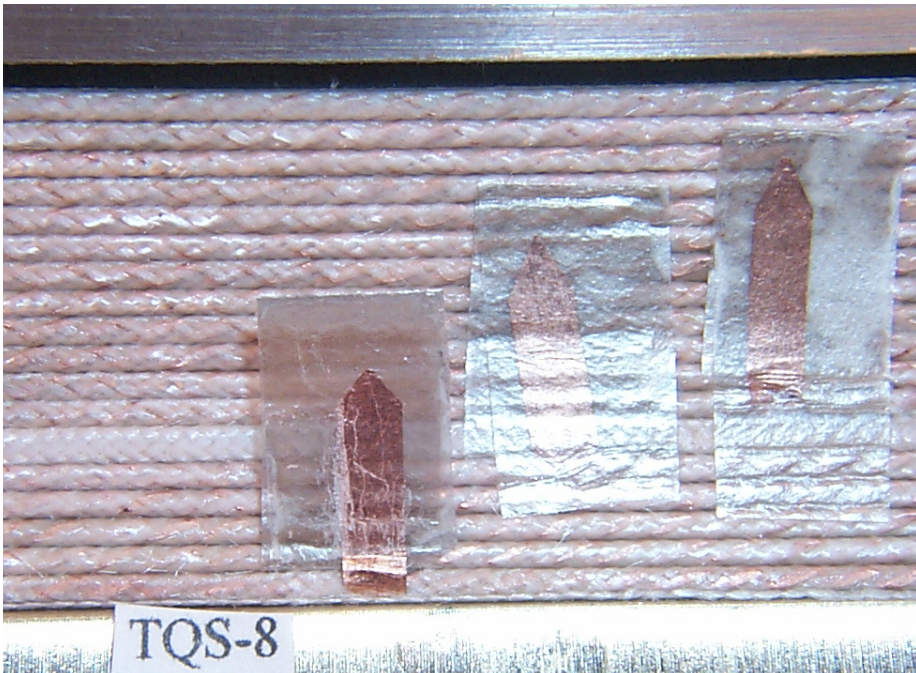



- Strain gauges
  - By **measuring strain**, they provide information about the stress status of coil and components (see Unit 19).

$$\sigma_x = \frac{E}{1-\nu^2} (\varepsilon_x + \nu\varepsilon_y)$$

$$\sigma_y = \frac{E}{1-\nu^2} (\varepsilon_y + \nu\varepsilon_x)$$

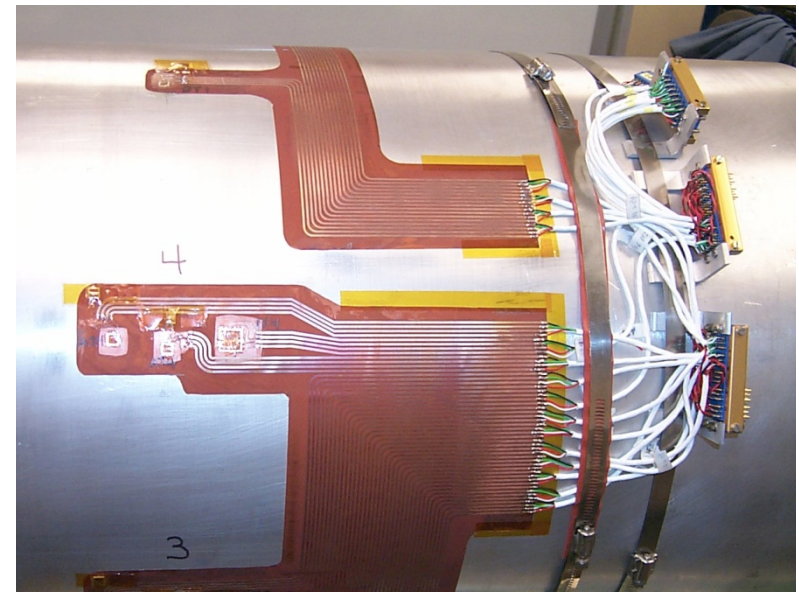
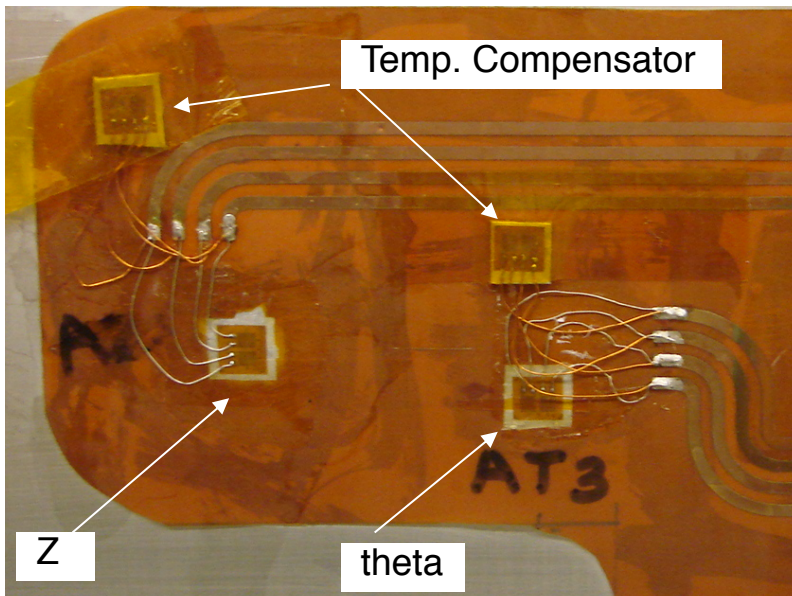



- **Elastic modulus and arc length** are measured in different locations along the longitudinal direction. A measuring tool moves along the coil applying pressure.

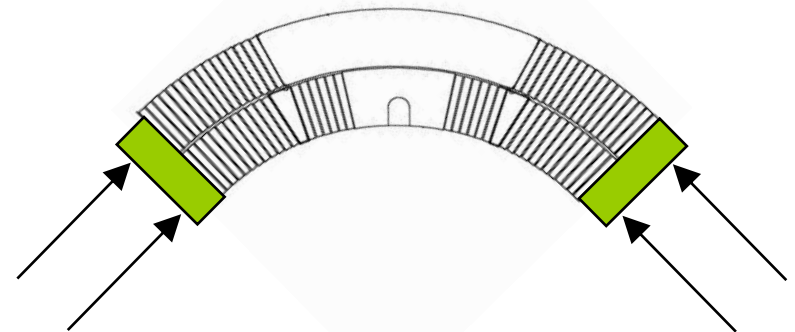
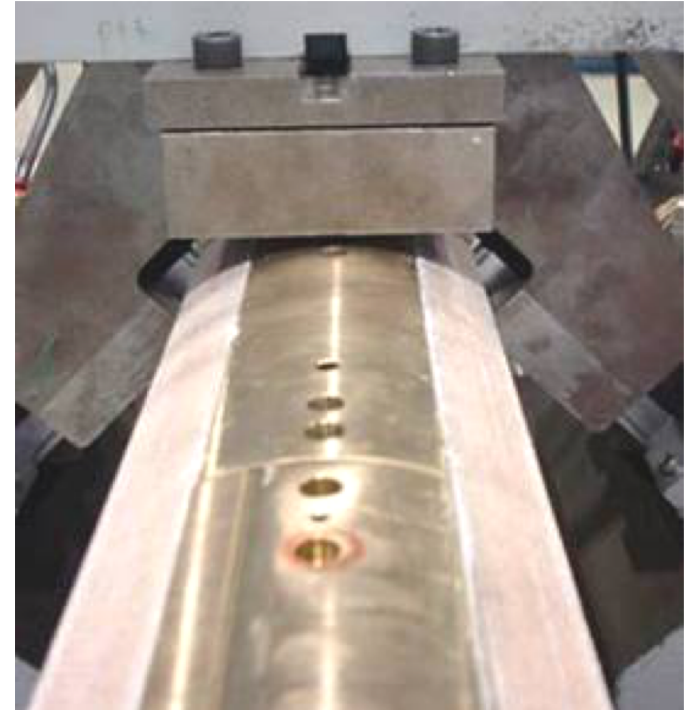
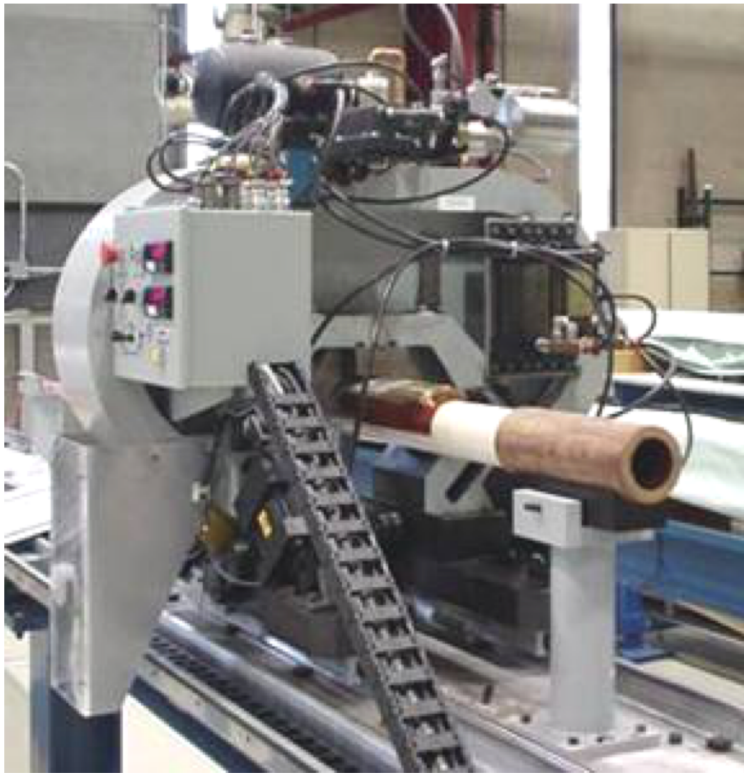



# Cable Splices



- Almost every magnet needs them
  - Coil leads
    - ◆ Sometimes double up for stability
    - ◆ Provide flexibility for  $\text{Nb}_3\text{Sn}$  magnets
  - Coil-to-coil
    - ◆ Between layers if using different cable for each layer - grading
    - ◆ External or internal

Always aim to locate in low field region



# Nb-Ti – Nb-Ti splices



- If a coil is composed by layers with the same conductor, the outer layer can be wound on the cured inner layer and then cured as well.
- Alternatively, especially in the presence of different cables, the two (or more) layers can be wound and cured separately and then **connected through internal or external splices** (solder joints).
- Solder is usually 40% lead and 60% tin, or silver-tin (5% silver) with a resistivity of less than  $2-3 \times 10^{-9} \Omega\text{-m}$ .
- The temperature rise in the joints is of the order of a few mK.
- It is possible to mess it up! More on that later in the course.

## Internal Ramp Splice Design

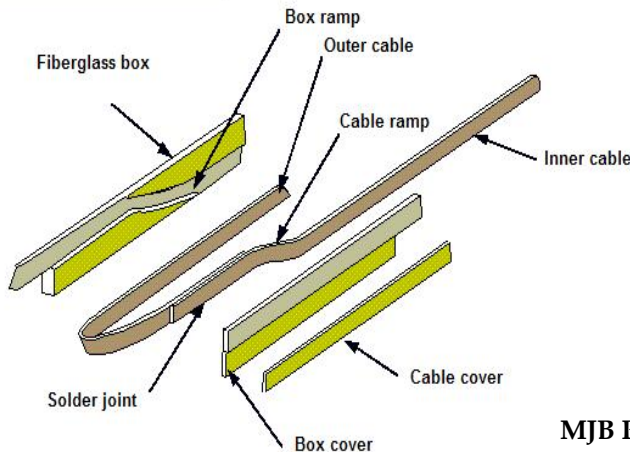

MJB Plus, Inc., [2]

## External Splice

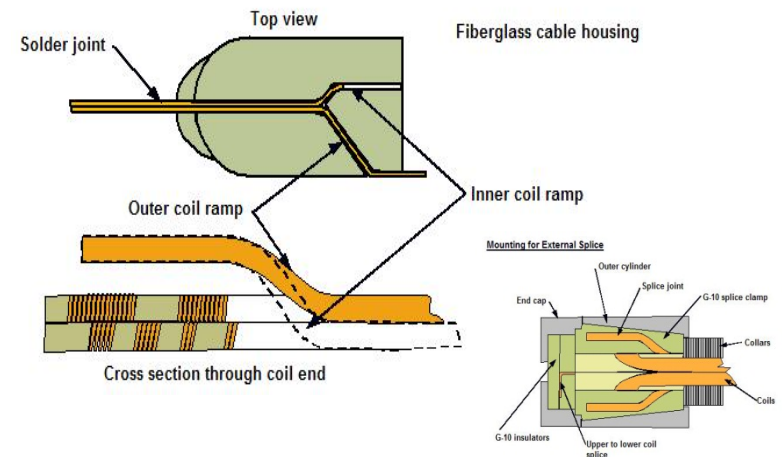





# Nb<sub>3</sub>Sn – Nb -Ti splices

- Nb-Ti leads are compressed against Nb<sub>3</sub>Sn cables for a length of about 1-1.5 times the pitch length and soldered using a temperature controlled fixture.

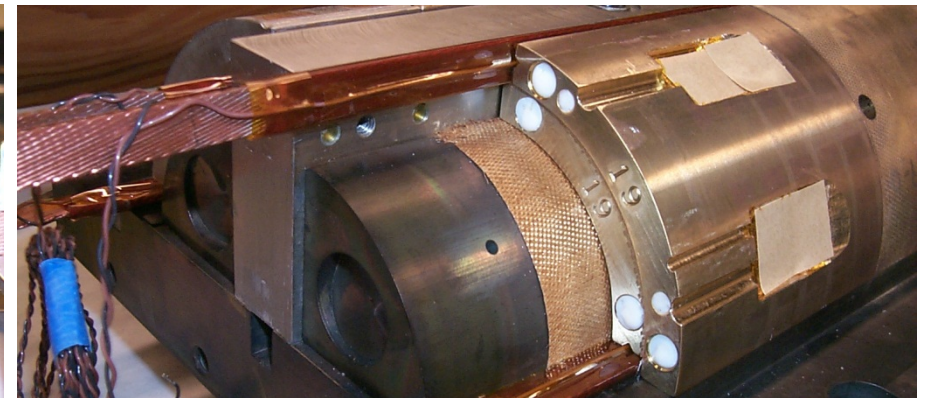
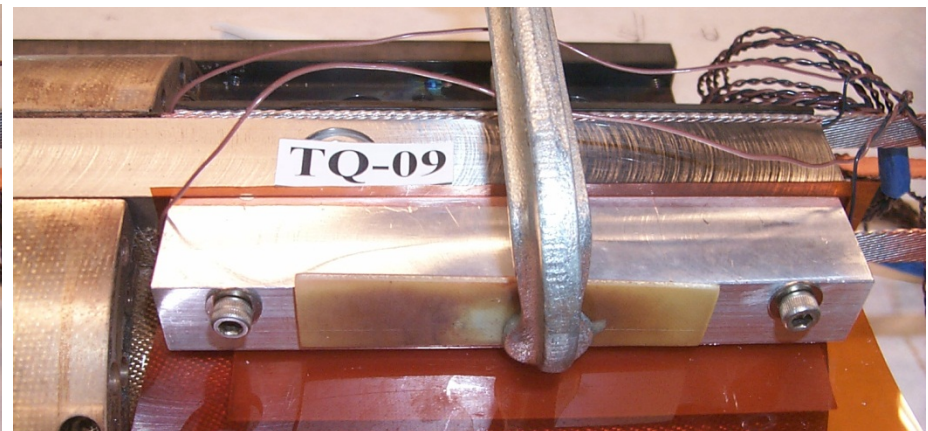



# Final assembly



- Additional layers of insulations, usually composed by **polyimide films**, are added around the coils. Besides the electrical function of guaranteeing coil-to-coil and coil-to-ground insulation, they also provide slip surfaces during assembly of the surrounding support structure (collars).
- **Quench protection heaters** are also added to warm the entire coil after a quench. The quench heaters consist stainless steel strips in a sandwich of polyimide insulating foils.
- The conductor must be **protected** from the clamping structure.
  - In the HERA dipoles, 6 layers of kapton 125 mm thick.
  - In the RHIC dipole, glass-phenolic form
  - In the SSC, kapton
  - In the LHC dipoles, coil protection sheets made of stainless steel are used.

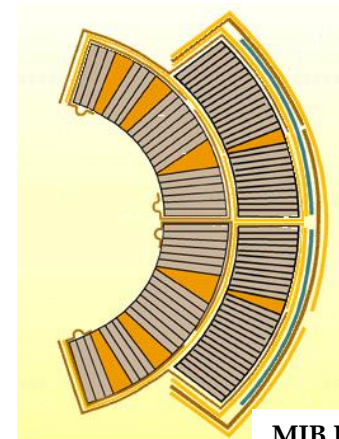
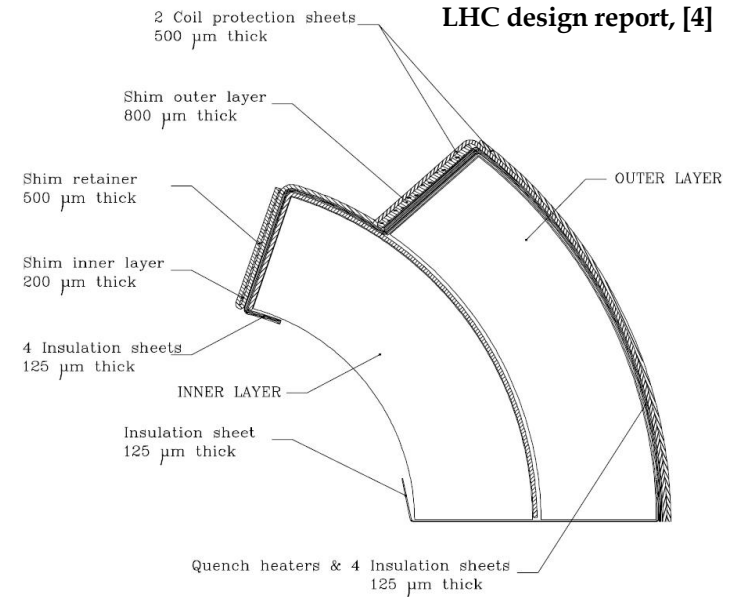

MJB Plus, Inc., [2]



# Practical examples

## LHC dipole coil (Nb-Ti) fabrication steps



- Winding
- Curing
  - Coil at 190 °C under a pressure of 35 MPa
- Surfacing of the coil ends
  - Voids in the ends are filled with resin
- Measurements of coil azimuthal size
- Superposition of the outer layer onto the inner
- Splicing
- Shimming of the end region
- Assembly of four poles around the bore tube
- Instrumentation (quench heaters) and insulation)

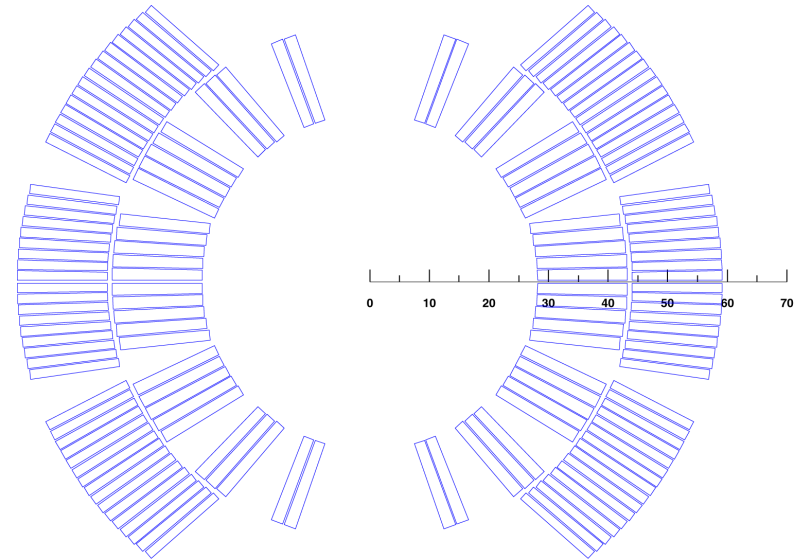



# Practical examples

## TQ quadrupole coil (Nb<sub>3</sub>Sn) fabrication steps



- Winding of inner layer
- Curing of inner layer
  - Coil at 150 °C under a pressure of 30 MPa
- Winding of outer layer
- Curing of inner and outer layer
  - Coil at 150 °C under a pressure of 30 MPa
- First instrumentation phase
  - voltage taps
- Reaction
- Splicing
- Second instrumentation phase
  - Voltage taps, strain gauges, quench heaters
- Impregnation

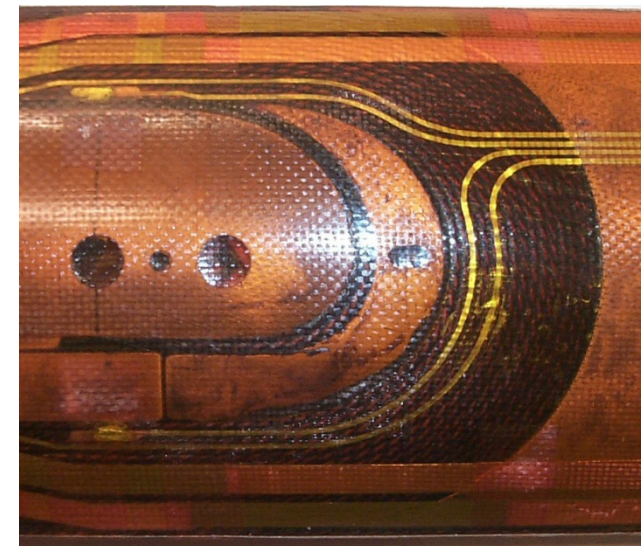
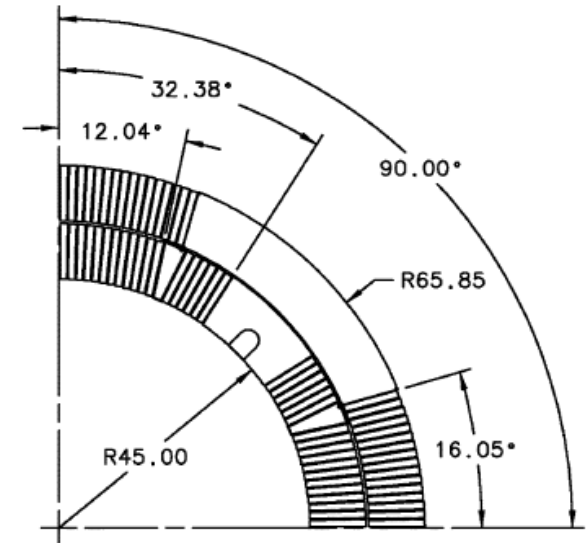



# Summary



- Steps in the fabrication of a superconducting coil
  - **Winding**
  - **Curing**
  - **Reaction**
  - **Impregnation**
- Instrumentation is implemented to monitor the mechanical, electrical and thermal behavior of the coils.
  - Remember: Sometimes less is more!



# Acknowledgement



Thanks to Paolo Ferracin, CERN for use of his slides.



# References



- [1] L. Rossi, “Superconducting Magnets”, CERN Academic Training, 15-18 May 2000.
- [2] MJB Plus, Inc. “Superconducting Accelerator Magnets”, an interactive tutorial.
- [3] K.-H. Mess, P. Schmuser, S. Wolff, “Superconducting accelerator magnets”, Singapore: World Scientific, 1996.
- [4] “LHC design report v.1: the main LHC ring”, CERN-2004-003-v-1, 2004.
- [5] R. Gupta, *et al.*, “React and wind common coil dipole”, talk at *Applied Superconductivity Conference 2006*, Seattle, WA, Aug. 27 - Sept. 1, 2006.
- [6] Slides from J. C. Perez on coil fabrication process in MDT section at CERN.