



John Adams Institute for Accelerator Science

Unifying physics of accelerators, lasers and plasma

Imperial College
London



ROYAL
HOLLOWAY
UNIVERSITY
OF LONDON



UNIVERSITY OF
OXFORD

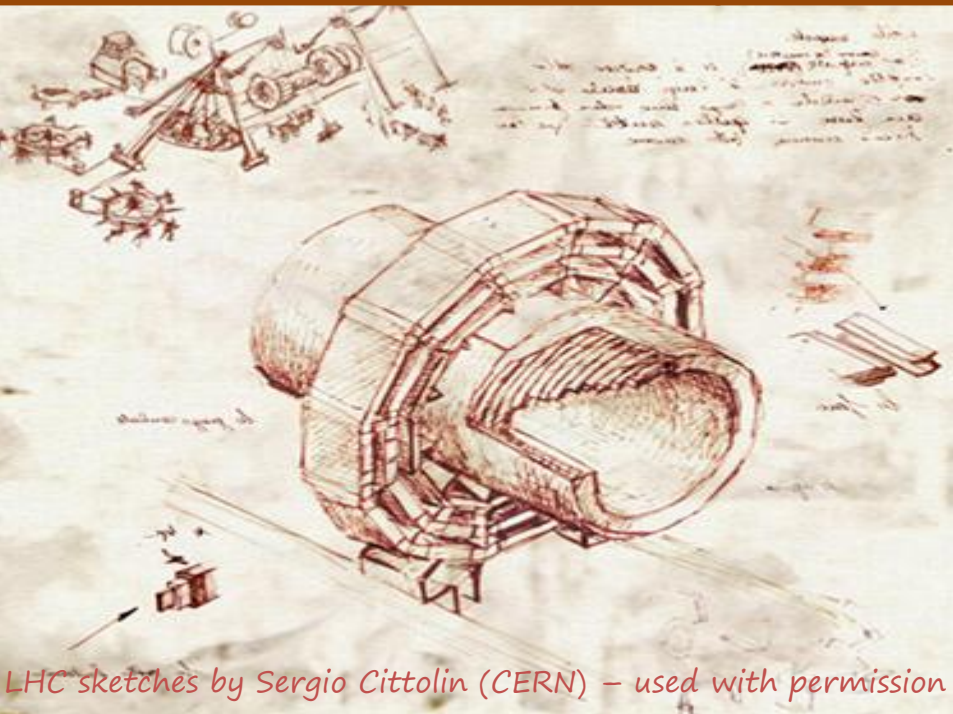

LHC sketches by Sergio Cittolin (CERN) – used with permission

Prof. Andrei A. Seryi
John Adams Institute

Lecture 10: Advanced beam
manipulation (I) – short and small

• USPAS 2016

June 2016

Scope of the lecture – short and small

- **Effects/techniques for creation of short pulses**
 - **Bunch compression and Coherent Synchrotron Radiation**
 - **Q-switching techniques**
- **Addition of beams for higher intensity**
 - **Beam injection techniques**
 - **Laser cavities**
 - **Coherent addition of laser pulses & ICAN**
- **Focusing the beams to small size**
 - **Final focus for beams**

Accelerators-Lasers-Plasma

Degree of synergy & topics

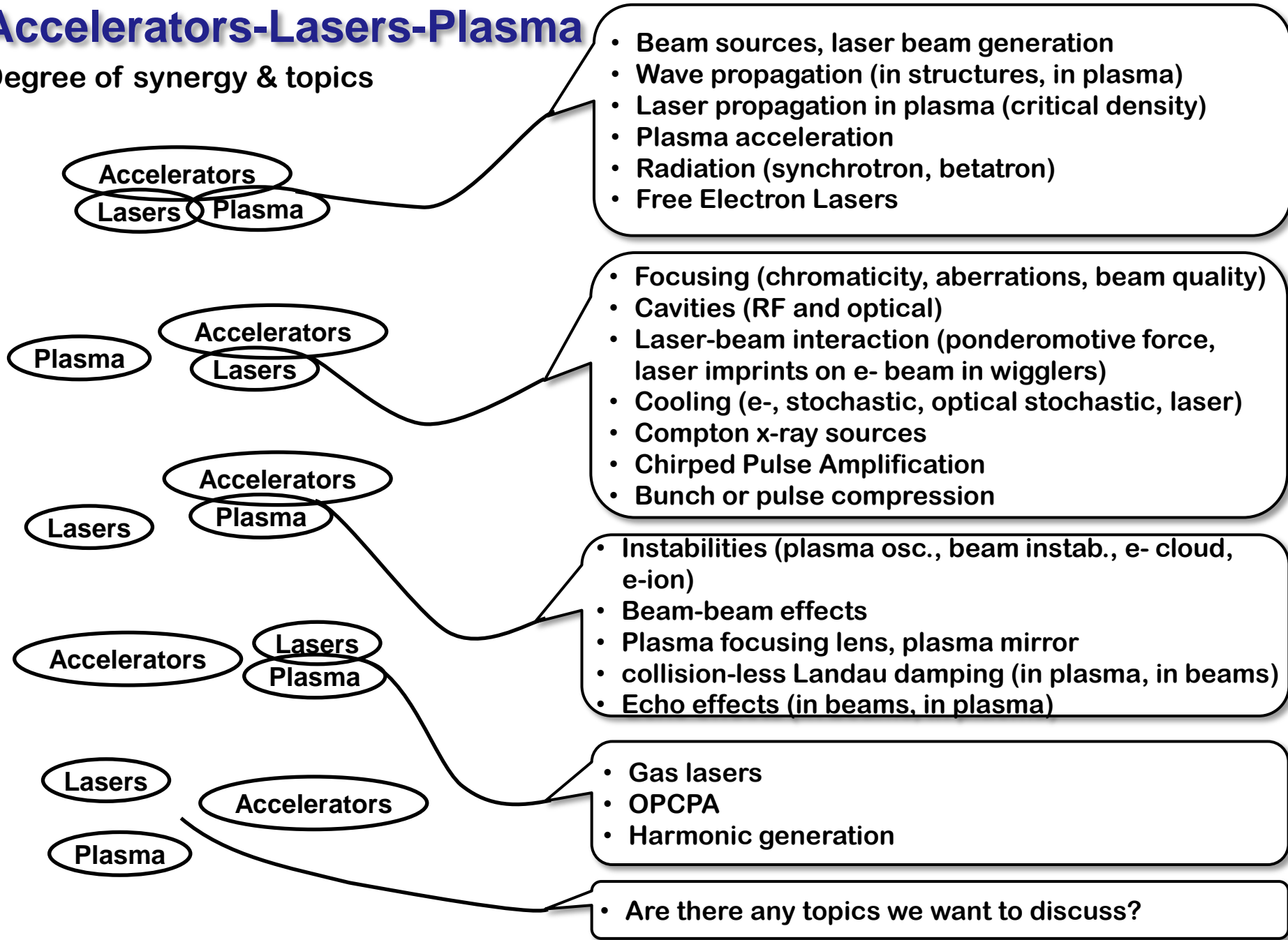

- Beam sources, laser beam generation
- Wave propagation (in structures, in plasma)
- Laser propagation in plasma (critical density)
- Plasma acceleration
- Radiation (synchrotron, betatron)
- Free Electron Lasers

- Focusing (chromaticity, aberrations, beam quality)
- Cavities (RF and optical)
- Laser-beam interaction (ponderomotive force, laser imprints on e- beam in wigglers)
- Cooling (e-, stochastic, optical stochastic, laser)
- Compton x-ray sources
- Chirped Pulse Amplification
- Bunch or pulse compression

- Instabilities (plasma osc., beam instab., e- cloud, e-ion)
- Beam-beam effects
- Plasma focusing lens, plasma mirror
- collision-less Landau damping (in plasma, in beams)
- Echo effects (in beams, in plasma)

- Gas lasers
- OPCPA
- Harmonic generation

• Are there any topics we want to discuss?

Bunch Compression (I)

In many applications the length of the bunch generated even by a photo-injector (few ps) is too long. Tens of fs might be required.

The bunch length needs to be shortened. This can be achieved with velocity bunching when E-z correlation is created in the photo-gun source



Since velocity bunching is based on the velocity's dependence on energy, it can work only for weakly relativistic beams

Bunch Compression (II)

In many applications the length of the bunch generated even by a photo-injector (few ps) is too long. Tens of fs might be required.

The bunch length needs to be shortened. This is usually achieved with a magnetic compression system.

A beam transport line made of four equal dipole with opposite polarity is used to compress the bunch. In this chicane the time of flight (or path length) is different for different energies

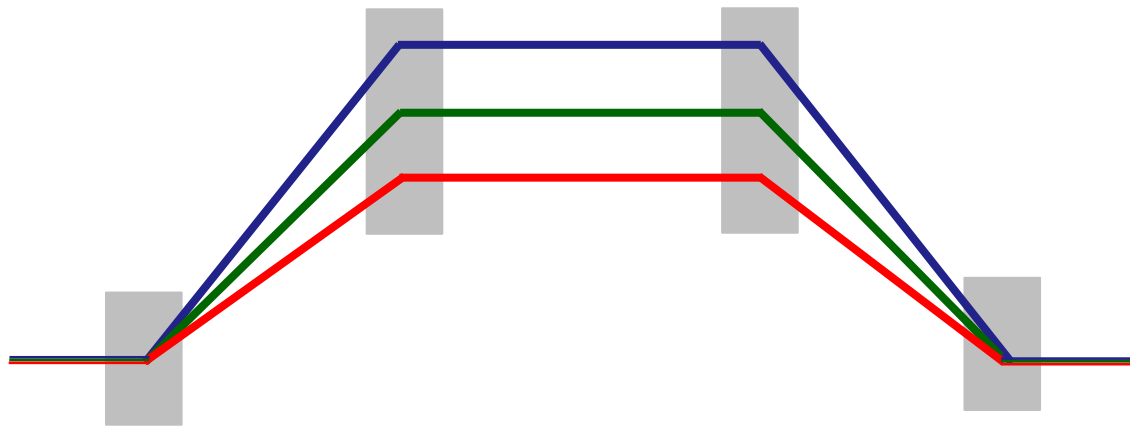

blue = low energy
red = high energy

The time of flight of the high energy particle is smaller ($v \sim c$...but it travel less !)

This effect can be used to compress the bunch length

Bunch Compression (III)

To exploit the dependence of the time of flight (or path length) for different energies we need to introduce an energy-time correlation in the bunch.

This is done using the electric field of an RF cavity with a suitable timing

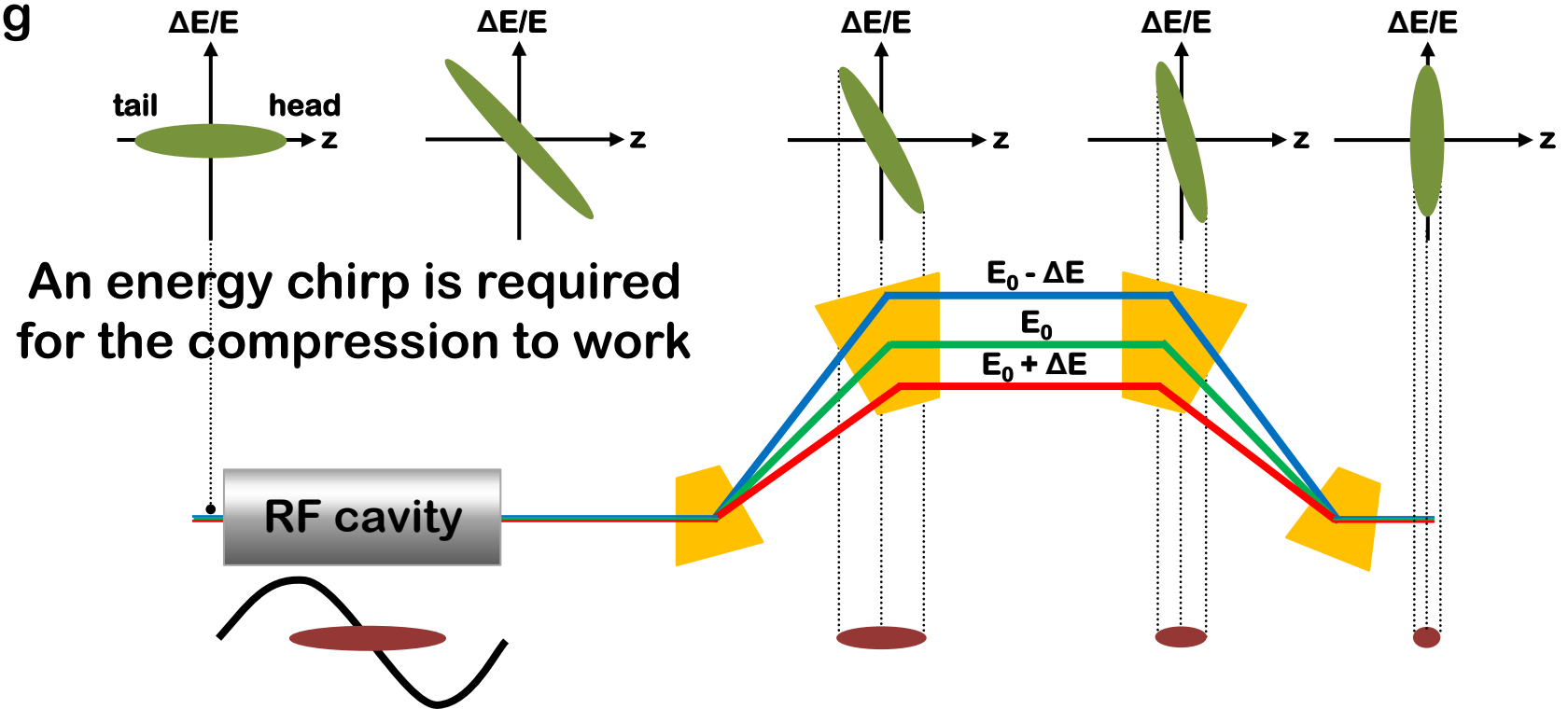

The high energy particle at the tail travels less and catches up the synchronous particle. The net result is the compression of the bunch

Bunch Compression (IV)

Bunch compression can be computed analytically.

Inside the RF cavity the energy changes with the position z_0 as

$$z_1 = z_0$$

$$\delta_1 = \delta_0 + \frac{eV_{\text{RF}}}{E_0} \cos\left(\frac{\pi}{2} - k_{\text{RF}}z_0\right)$$

In the linear approximation in (z, δ)

$$\begin{pmatrix} z_1 \\ \delta_1 \end{pmatrix} \approx \begin{pmatrix} 1 & 0 \\ R_{65} & 1 \end{pmatrix} \cdot \begin{pmatrix} z_0 \\ \delta_0 \end{pmatrix} \quad R_{65} = \frac{eV_{\text{RF}}}{E_0} \sin(\phi_{\text{RF}}) k_{\text{RF}}$$

In the chicane the coordinate changes as

$$z_2 = z_1 + R_{56} \delta_1 + T_{566} \delta_1^2 + U_{5666} \delta_1^3 \dots$$

$$\delta_2 = \delta_1$$

In the linear approximation

$$\begin{pmatrix} z_2 \\ \delta_2 \end{pmatrix} \approx \begin{pmatrix} 1 & R_{56} \\ 0 & 1 \end{pmatrix} \cdot \begin{pmatrix} z_1 \\ \delta_1 \end{pmatrix}$$

Bunch Compression (V)

The full transformation is, as usual, the composition of the matrices of each element and reads

$$\begin{pmatrix} z_2 \\ \delta_2 \end{pmatrix} \approx \mathbf{M} \cdot \begin{pmatrix} z_0 \\ \delta_0 \end{pmatrix} \quad \mathbf{M} = \begin{pmatrix} 1 + R_{65}R_{56} & R_{56} \\ R_{65} & 1 \end{pmatrix}$$

For a given value of R_{65} (energy chirp induced), the best compression that can be achieved is

$$\sigma_{z_2} = |1 + R_{65}R_{56}| \sigma_{z_0} = \frac{\sigma_{z_0}}{C}$$

C is the compression factor. It can be a large number!

Since the transformation is symplectic (i.e. area preserving \rightarrow Liouville theorem) the longitudinal emittance is conserved

$$\varepsilon = \sqrt{\sigma_z^2 \sigma_\delta^2 - \sigma_{z\delta}^2}$$

The minimum reachable bunch length is limited to the product of the energy spread times R_{56}

Bunch Compression (VI)

Further limitations to the achievable compression comes from the high current effect that we have neglected in the linear approximations.

These are longitudinal space charge, wakefields and **coherent synchrotron radiation (CSR)**

When taken into account, these effects can produce serious degradation of the beam qualities, e.g in simulations

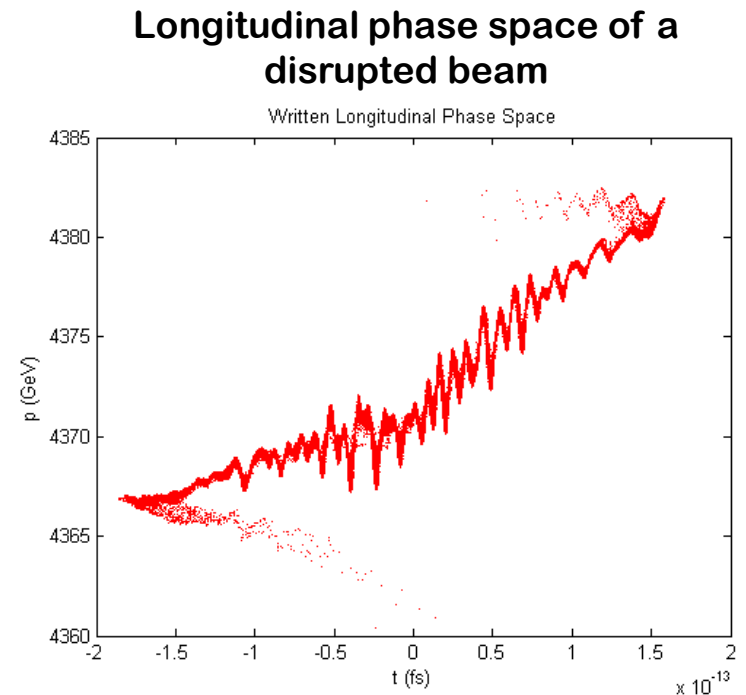
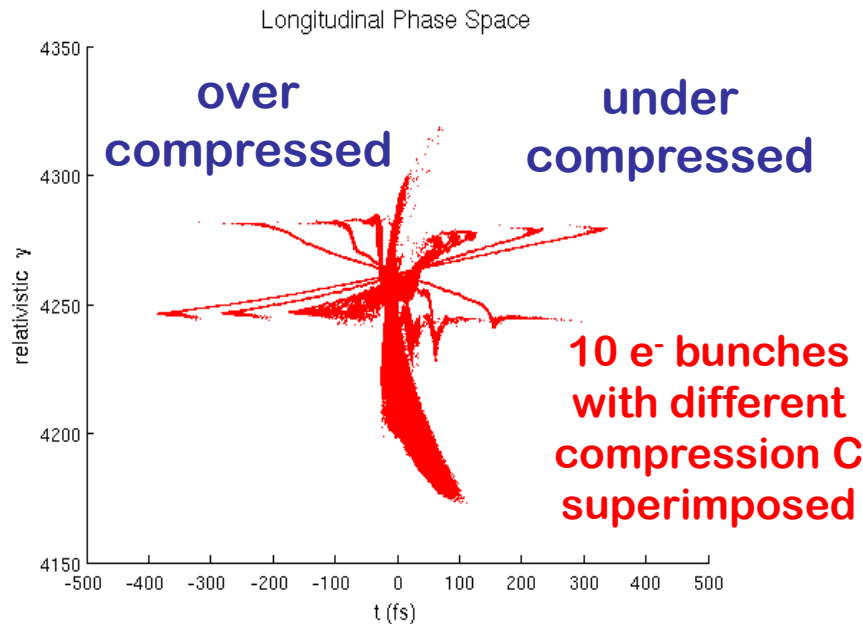

Coherent Synchrotron Radiation

We saw that for single particle SR is

$$\frac{dW}{dS} = \frac{2}{3} \frac{e^2 \gamma^4}{R^2}$$

Power loss

$$\omega_c = \frac{3}{2} \frac{c \gamma^3}{R}$$

Characteristic frequency

And the spectrum of SR looks like this:

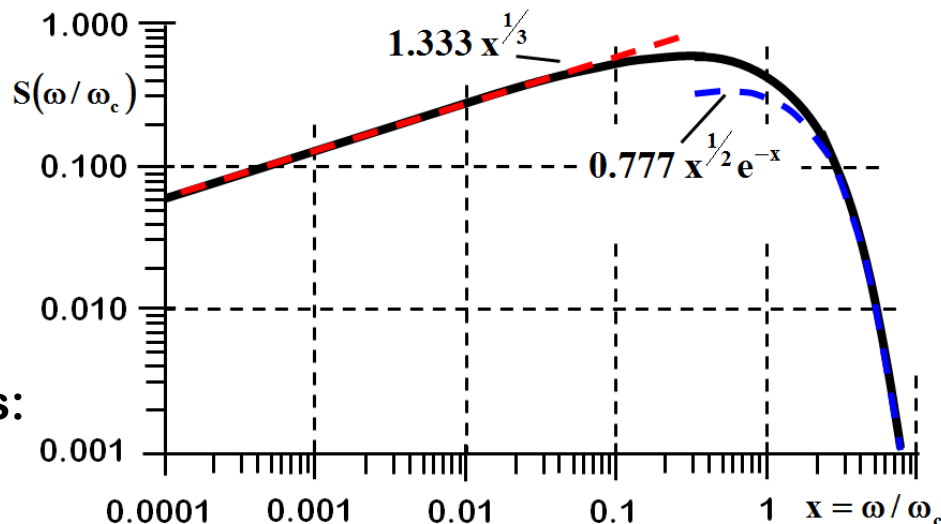

Assume we have bunch with N electrons and bunch length is σ

For certain frequencies c/ω can be longer than σ , thus the beam at this frequencies will radiate coherently

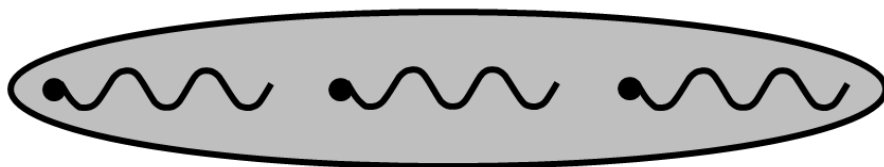

$c/\omega < \sigma$ - incoherent radiation

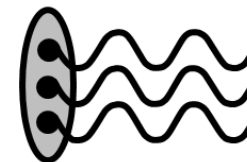

$c/\omega > \sigma$ - coherent radiation

Coherent Synchrotron Radiation

For frequencies where c/ω is longer than σ the beam radiate coherently, increasing radiated power as N^2

$$I_b(\omega) = I(\omega)N \left[1 + N \exp\left(-\left(\frac{\omega\sigma}{c}\right)^2\right) \right]$$

As typical bunch population $N \sim 10^{10}$, this increase power tremendously

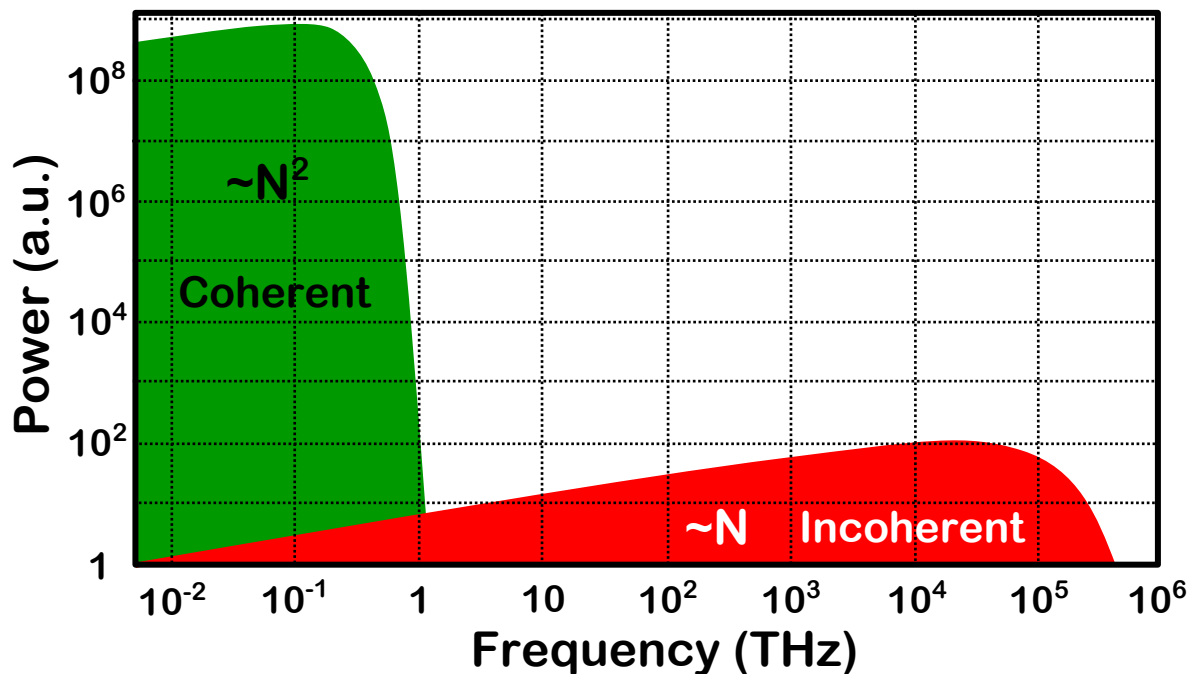

SR power spectrum emitted by a 0.2mm and 1.8mm bunch including single particle incoherent radiation

Coherent Synchrotron Radiation

Two particle beam with length between head and tail is $s=\sigma$, and lets look at beam core and its field

Condition that field of tail radiated in point A will overtake the head in point B is

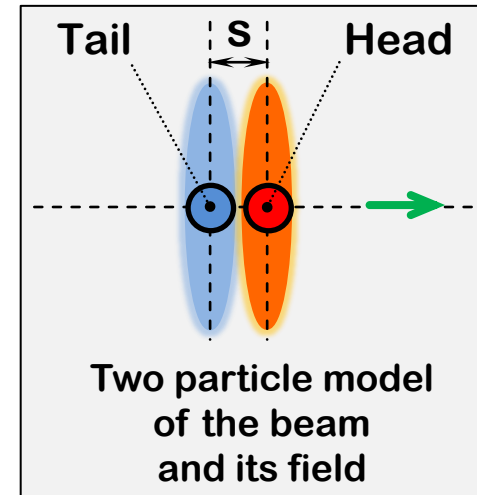

$$\text{Arc}(AB) - s = |\mathbf{AB}|$$

or

$$R \theta - s = 2R \sin(\theta/2) \Rightarrow s = R \theta^3 / 24$$

Thus the “overtaking distance”

$$L_0 = |\mathbf{AB}| = R \theta = 2(3sR^2)^{1/3}$$

And characteristic distance

$$r = L_0 \theta / 2 = 2(9s^2R)^{1/3}$$

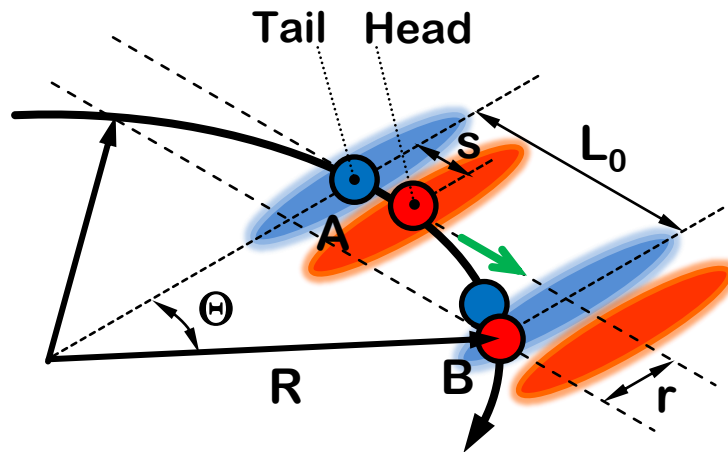

Coherent Synchrotron Radiation

We have estimated the characteristic distance $r = L_0 \theta / 2 = 2(9s^2 R)^{1/3}$

Let's estimate field of the bunch tail (radiated at A), acting on the head at B

Assume that the beam is uniform and has linear charge density $eN\lambda$ where $\lambda = 1/\ell_b$

The field at the characteristic distance

$$E_{\perp} = H_{\perp} \cong \frac{2N_e \lambda}{r}$$

Longitudinal field acting on the head is $E_{\perp} \cdot \theta$

Thus the longitudinal force acting on the head

$$F_{\parallel} = eE_{\perp} \cdot \theta = \frac{2Ne^2 \lambda \theta}{r} = \frac{2Ne^2 \lambda}{(3sR^2)^{1/3}}$$

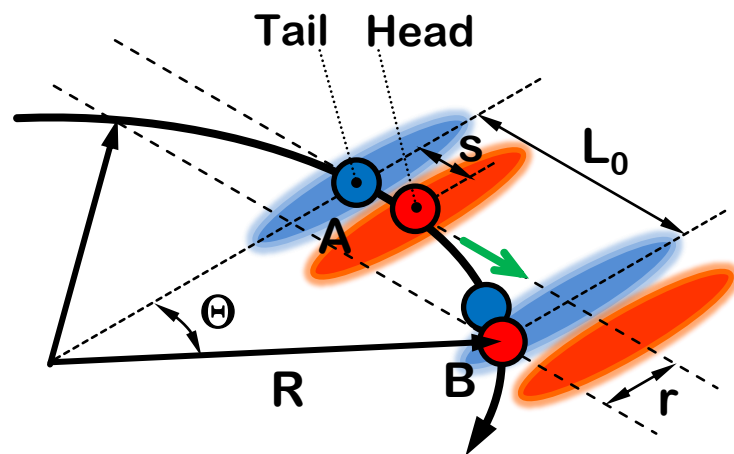

Take $s = \ell_b = 3^{1/2} \sigma$ and get

$$F_{\parallel} \approx \frac{2Ne^2}{3R^{2/3} \sigma^{4/3}} = \frac{2N r_e mc^2}{3R^{2/3} \sigma^{4/3}}$$

Coherent Synchrotron Radiation

The estimated longitudinal force acting on the beam:

$$F_{\parallel} \approx \frac{2N r_e m c^2}{3R^{2/3} \sigma^{4/3}} F_0$$

F_0 comes from accurate math

Head of the bunch accelerates
but bulk of the bunch decelerate

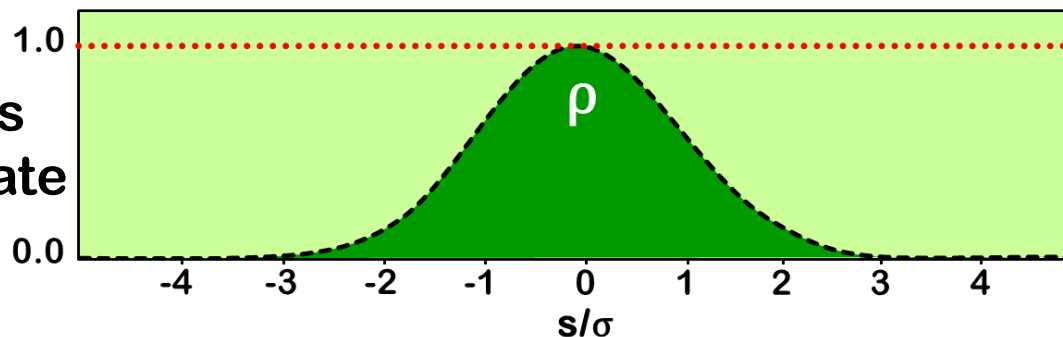
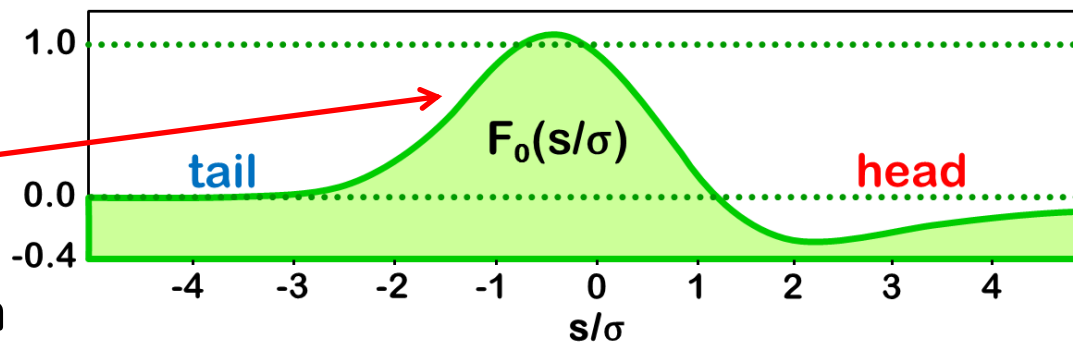

- **Effects of CSR**

- **Bunch compressors**

- Vacuum chamber can partially shield CSR effects

- **Bunch instability**

Short laser pulse generation - Q switching

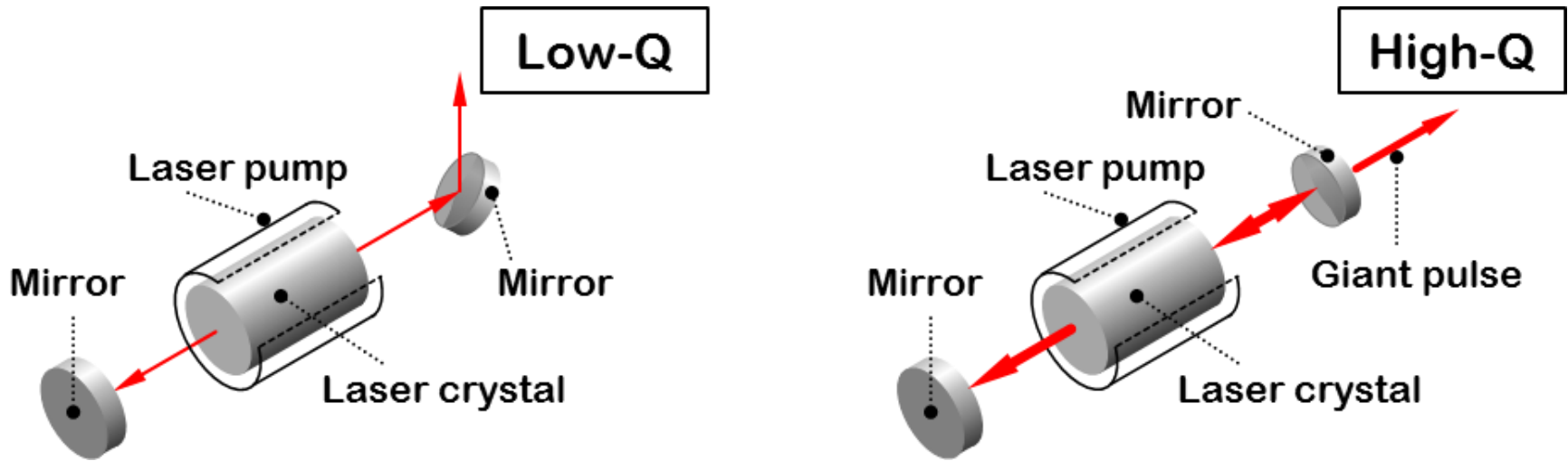

Basic idea:

- Laser gain medium is placed in the optical cavity
- At first moment, Q is low, pumping creates population inversion
- Then Q suddenly increased => avalanche of stimulated emission
- Thus, a giant and short pulse is emitted from the laser cavity

Short laser pulse generation - Q switching

ACTIVE Q - switching

Rotating mirror

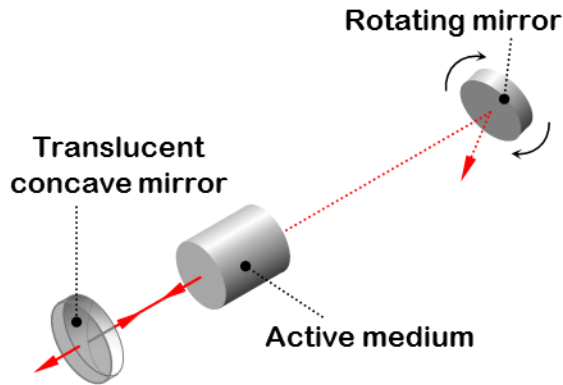

Electro-optic

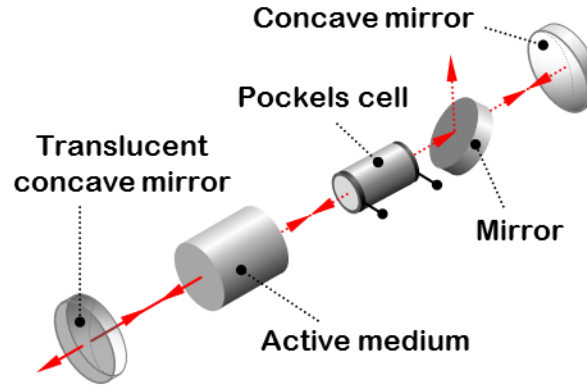

Acousto-optic

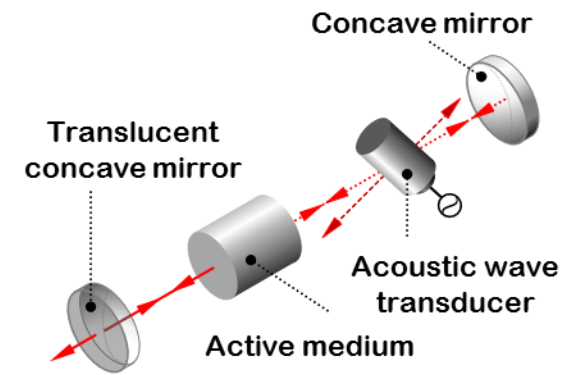

- There are variety of active methods to switch Q of the cavity

Short laser pulse generation - Q switching

PASSIVE Q - switching

Saturable absorber

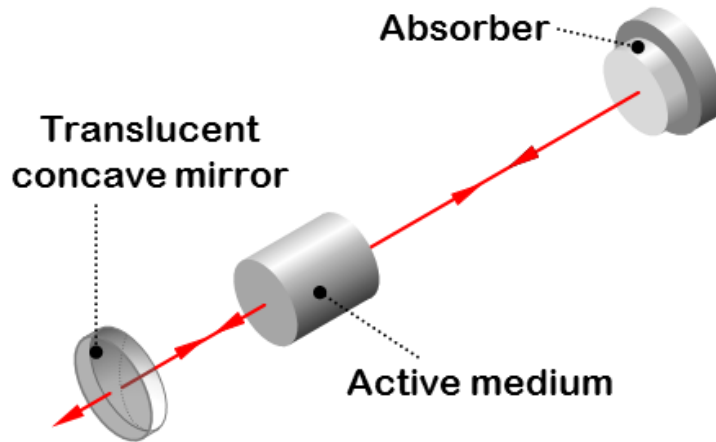

SESAM Saturable absorber

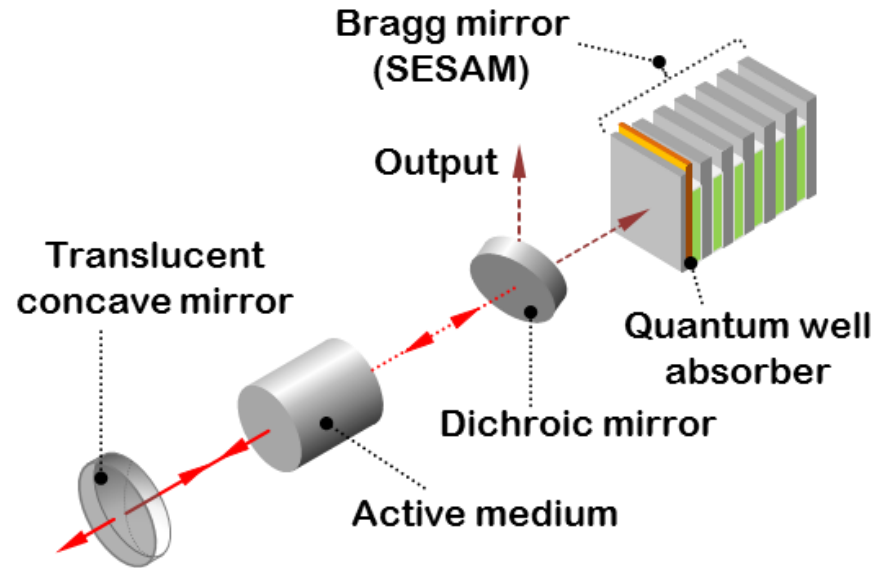

- There are various passive methods to switch Q of the cavity

Q-switching and Regen

Q-switching also used in Regenerative laser amplifiers. In “Regen”, an optical amplifier is placed inside a Q-switched cavity. Pulses of light from another laser (the “master oscillator”) are injected into the cavity by lowering the Q to allow the pulse to enter and then increasing the Q to confine the pulse to the cavity where it can be amplified by repeated passes through the gain medium. The pulse is then allowed to leave the cavity via another Q switch

Principle of operation:

- First, the gain medium is pumped
- Then, the initial pulse is injected into the resonator through a port which is opened for a short time (shorter than the round-trip time) with a switch.
- After that, the pulse can undergo many of resonator round trips, amplified to a high energy level.
- Finally, the pulse is released from the resonator with a second switch

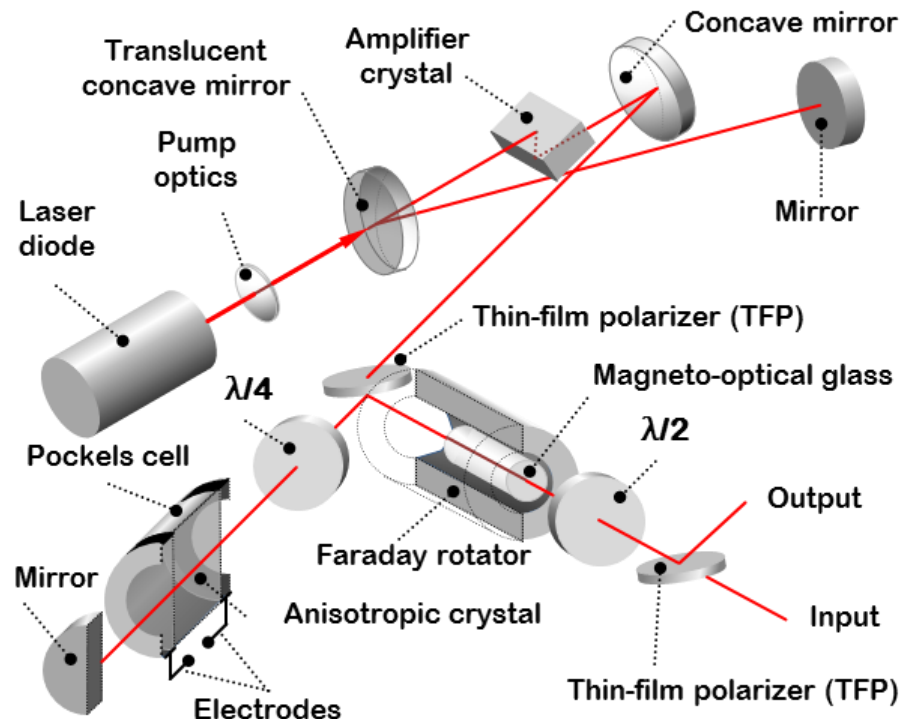

Setup of a regenerative amplifier. A Pockels cell, combined with a quarter-wave plate and a thin-film polarizer (TFP), acts as an optical switch. The Faraday rotator is used for separating input and output pulses

Mode locking

- **Technique for creating short laser pulses**

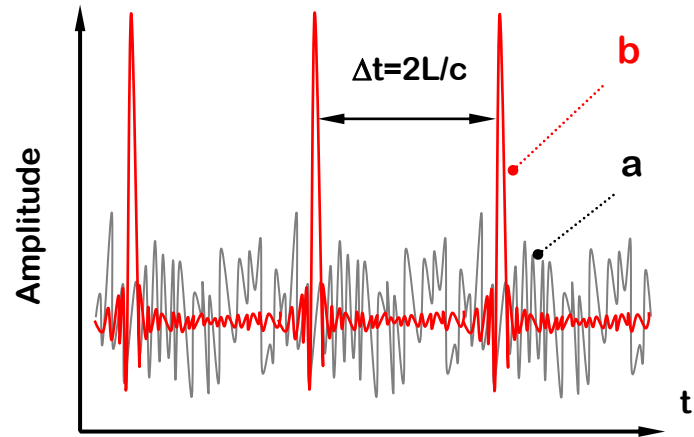
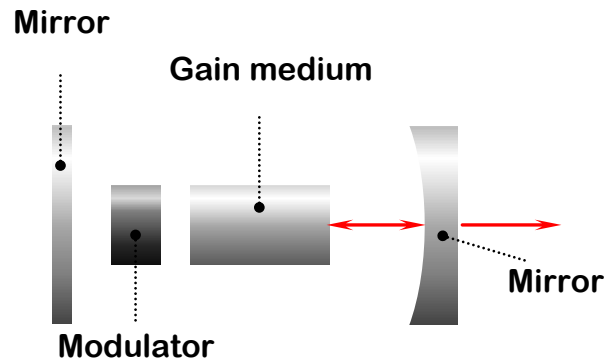

- **Fast modulator pulsing in sync with round-trip time in the cavity**
- **Photons are clustered in time around modulator open moments**
- **In frequency domain this is equivalent to selecting only some modes from the range of modes which fits to the finite bandwidth of the laser cavity => the term “mode locking”**

Laser interactions on beams in wigglers

- From FEL lecture
 - we have seen that light of a resonant harmonic exponentially amplified in undulator, taking energy from e-beam
- The inverse is also true
 - Sending light (from a laser) at a resonant harmonic will affect e-beam
 - Inverse FEL
- This is the basic of many techniques for manipulation of e-beam
 - To make short pulses of radiation
 - Or to generate higher harmonics
 - Or to create two colour FEL pulse
 - Etc.

Self-seeding in FELs

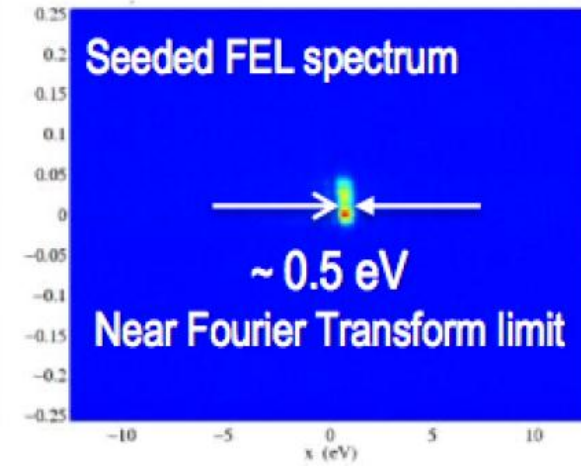
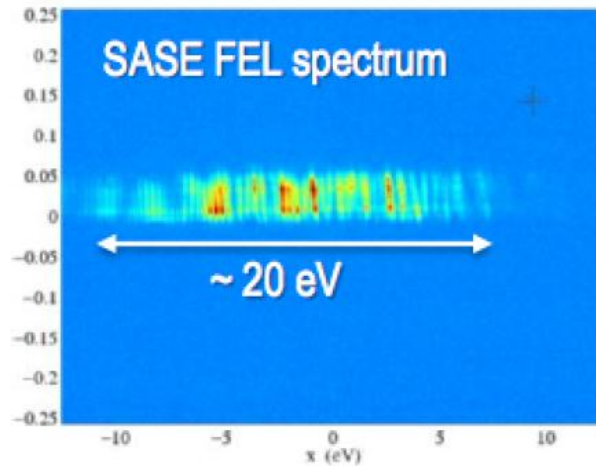
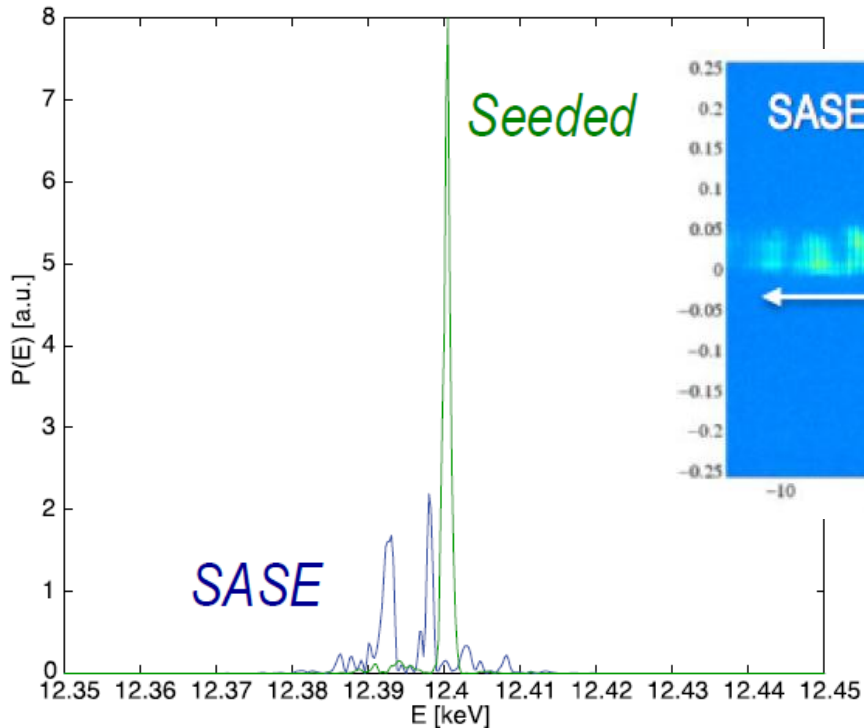
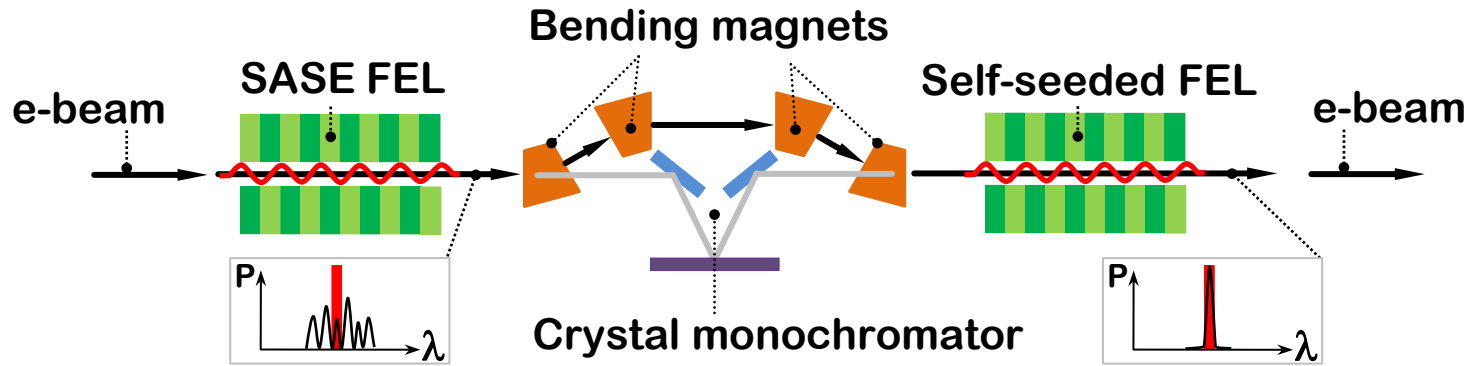

Developed and tested at LCLS (SLAC)

Laser heater

- Issue in FEL:
 - Energy spread from photo-cathode gun is very small
 - CSR instability cause micro-bunching – bad for FEL
- The need to increase the uncorrelated energy spread to cure CSR instability
 - Laser heater (laser + wiggler = act as inverse FEL to heat e-beam)

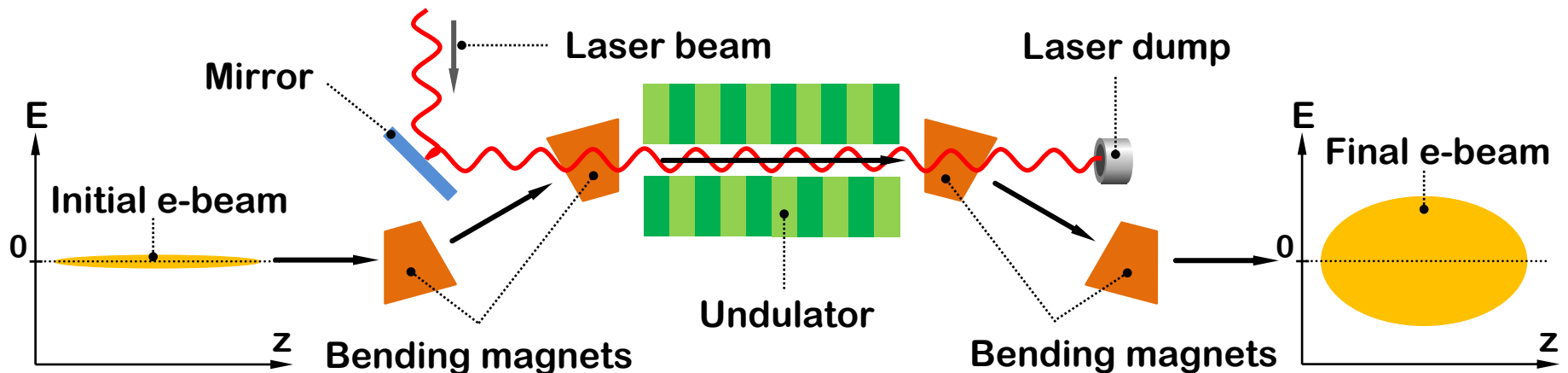

Huang (SLAC), FEL 04

Laser slicing

Laser slicing for generating femtosecond synchrotron pulses

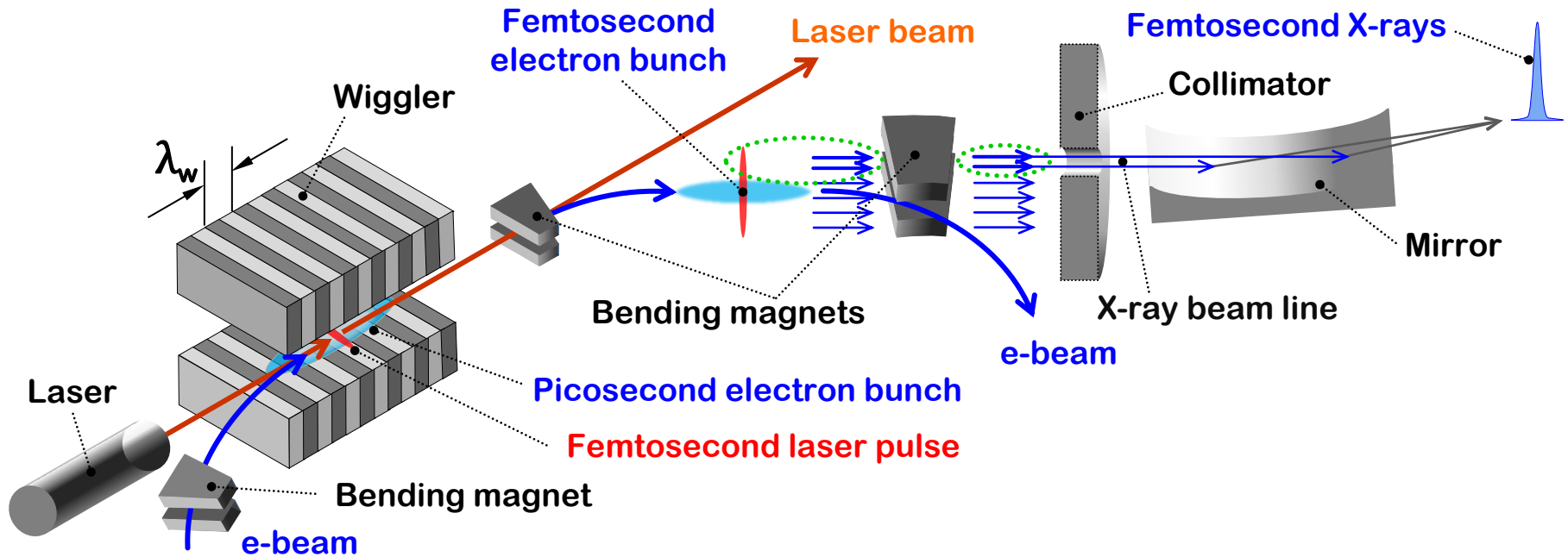

A) Overlapping short laser beam with bunch centre, meeting the resonance condition, modulates the energy in the short “slice”

$$\lambda_L = \lambda_S = \frac{\lambda_W}{2\gamma^2} \left(1 + \frac{K^2}{2} \right)$$

B) In a dispersive bend the modulated beam is separated transversely from the rest of the bunch

C) Imaged short pulse radiation is spatially separate from radiation from the “core” (rest of the bunch)

A. A. Zholents and M. S. Zolotarev, Phys. Rev. Lett. 76, 912 (1996), R. W. Schoenlein et al., Science 287, 2237 (2000)

Echo-enabled Harmonic Generation (EEHG)

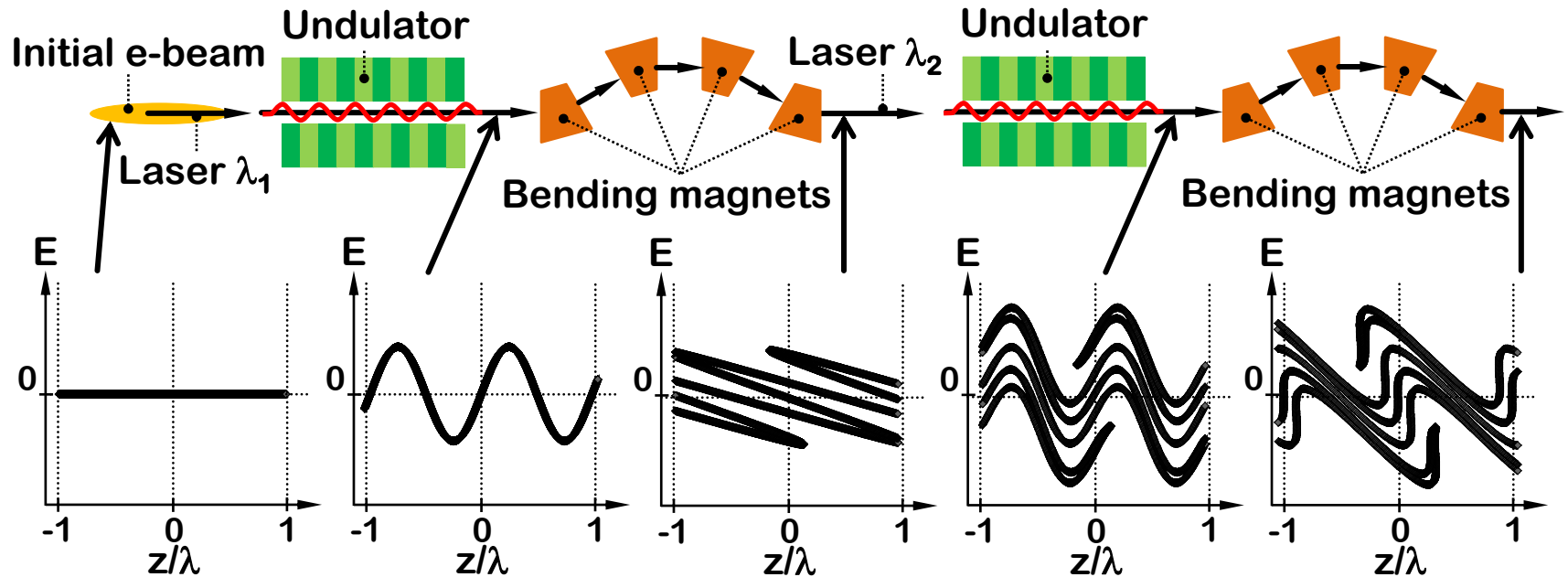

- First wiggler + laser modulates the energy
- First chicane creates energy bands of narrow width ($\ll \sigma_{E0}$) at each z
- Second wiggler + laser modulates all of the bands
- Second chicane converts these modulations into density modulations at harmonics of the laser

G. Stupakov PRL 102, 074801 (2009)

Echo-enabled Harmonic Generation (EEHG)

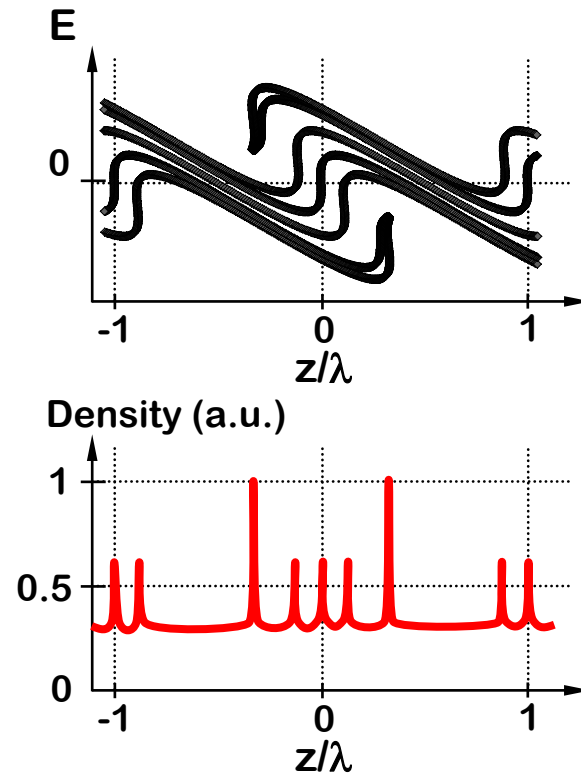

Phase space and density profile of an EEHG modulated beam

G. Stupakov PRL 102, 074801 (2009)

Beam or pulse addition

- Particles
- Light
 - This is the area where there are fundamental differences

Liouville's theorem

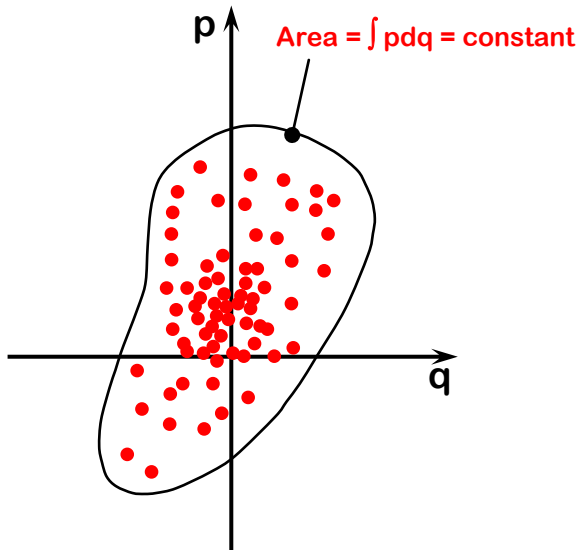

Liouville's theorem:

"In the vicinity of a [charged] particle, the particle density in phase space is constant if the particle move in an external magnetic field or in a general field in which the forces do not depend upon velocity"

Some obvious consequences:

- Emittance conservation (if accelerating, $\gamma\varepsilon$ is constant)
- Cooling (SR, electron, stochastic) – OK, as forces depend on v
- Cannot stack bunches on top of each other in phase space – need to inject in neighboring areas of phase space

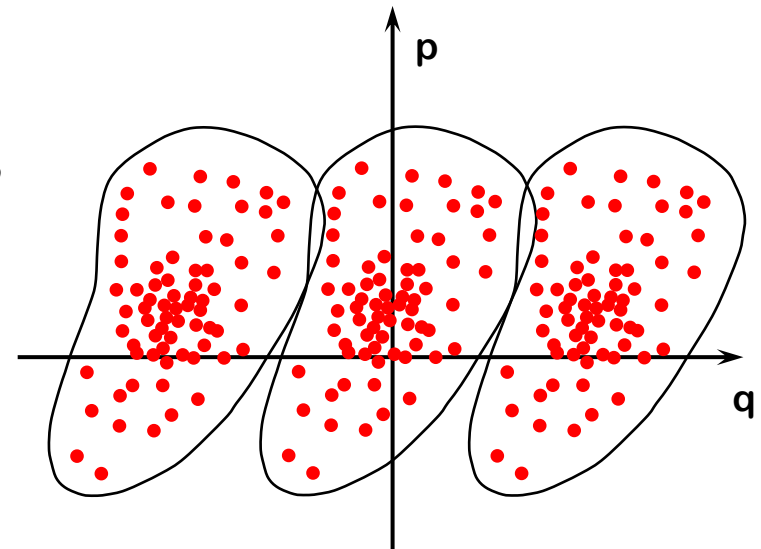

Injection & extraction

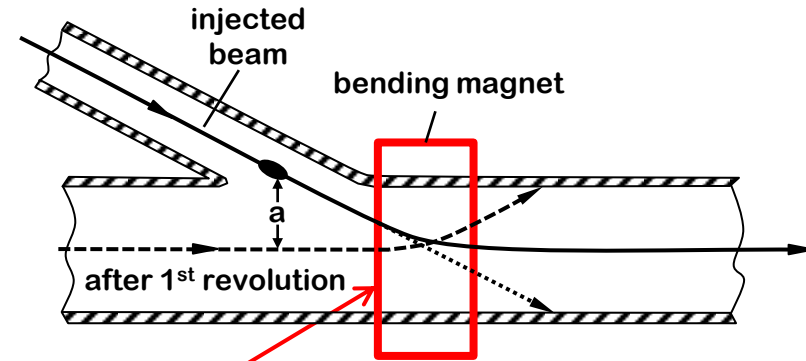
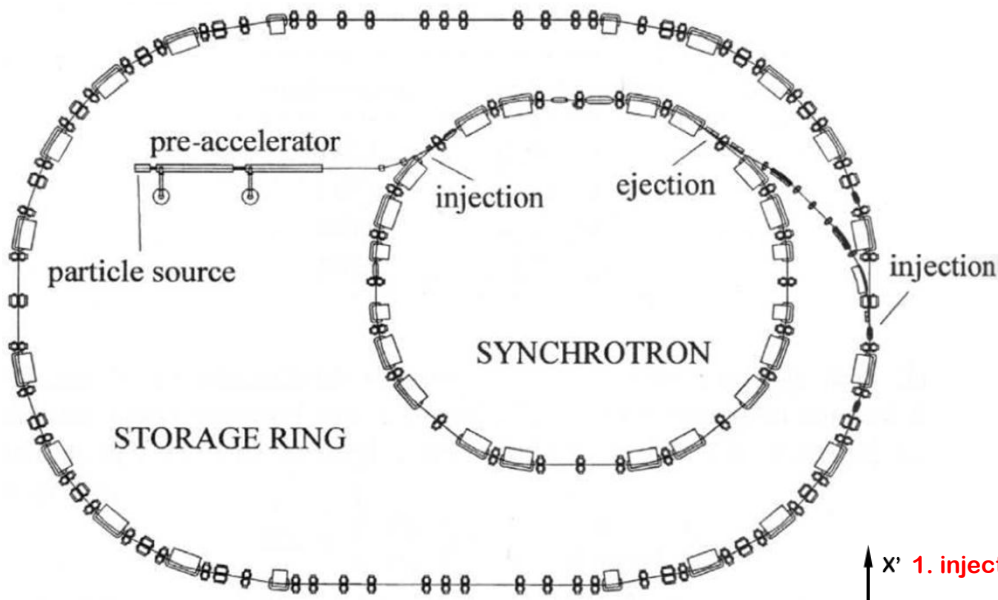

This bend must switch fast - kicker

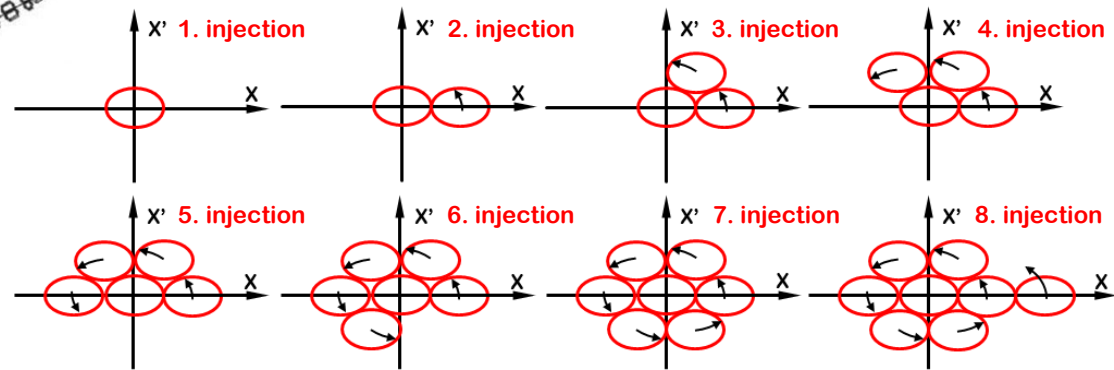

Transverse stacking

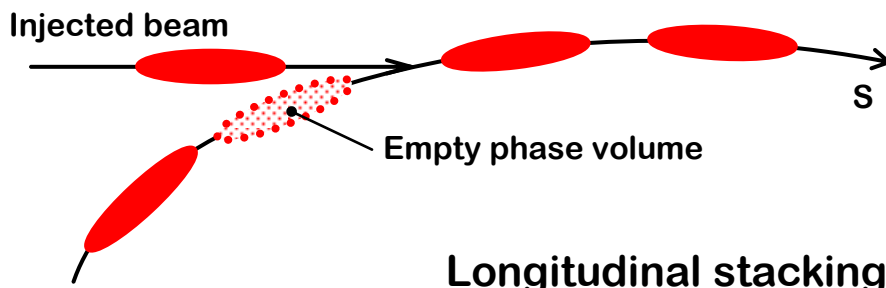

Longitudinal stacking

Charge exchange injection

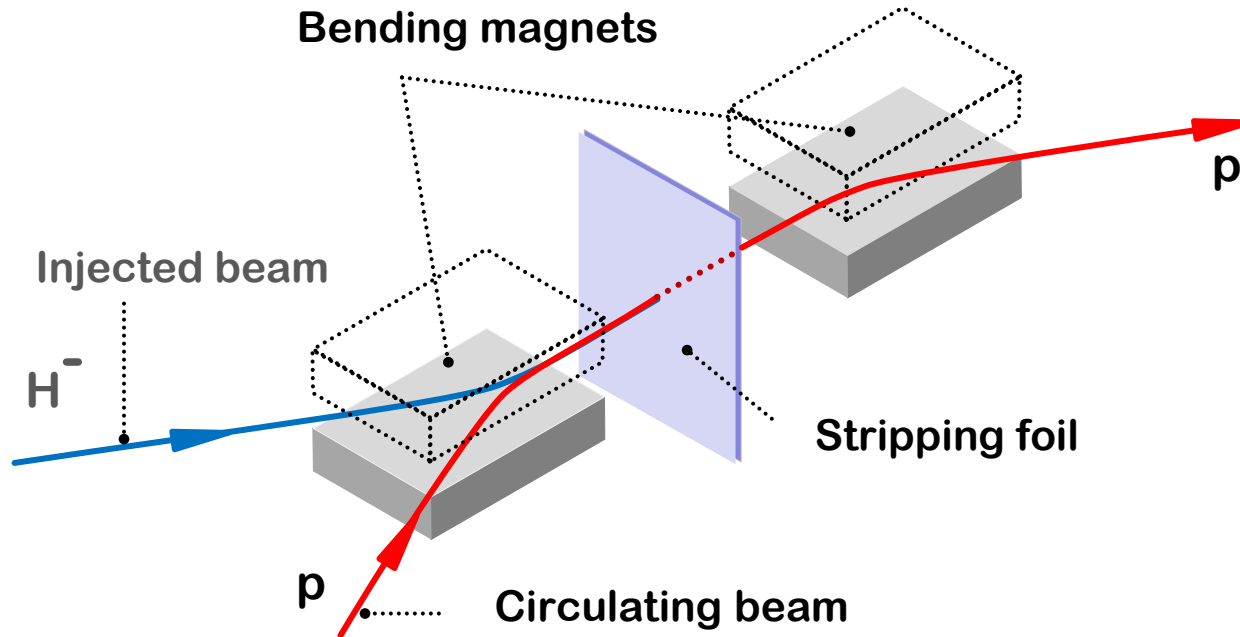

- Inject H^- ions, ions convert to protons at the foil
- Can inject many times into the same phase space
- Limited by scattering of circulating beam in the foil

Optical cavities

One can imagine various types of cavities

One of important consideration – how stable the cavity (and light pattern in it) with respect to small changes of its parameters

Practical cavity needs to be as stable as possible

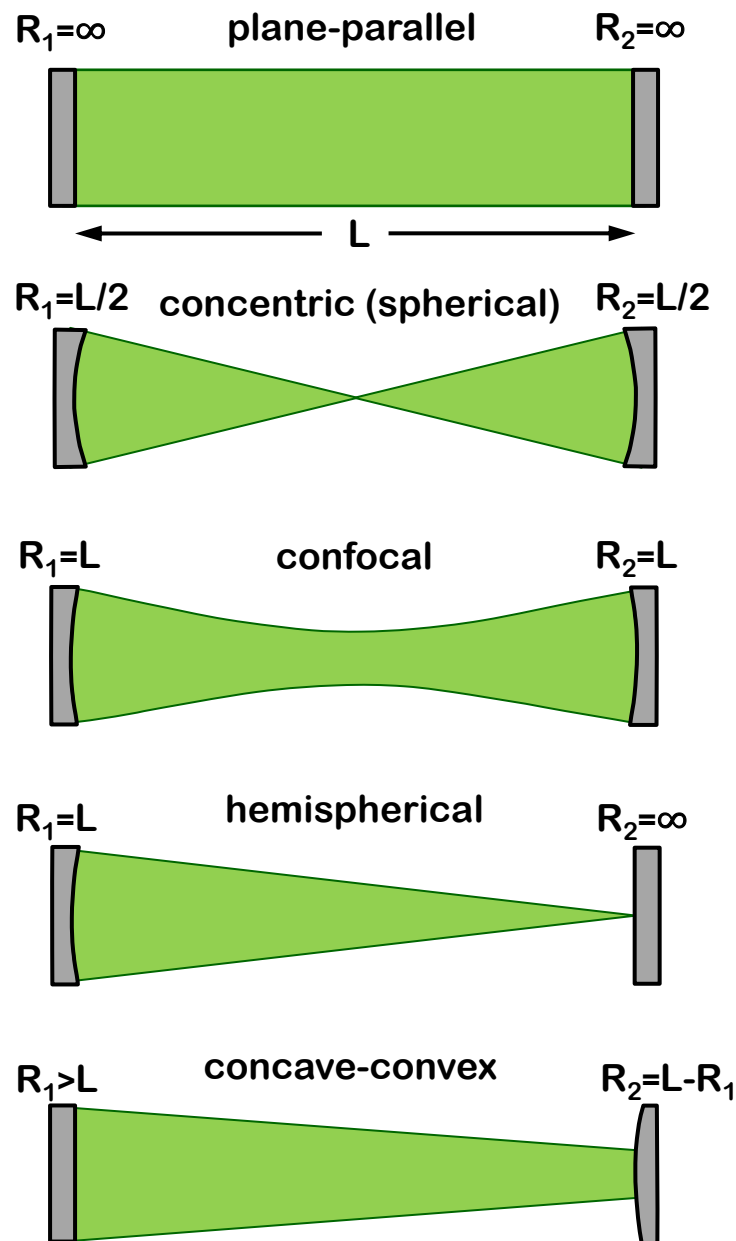

Optical cavity suitable for e-beam interaction

Two mirror cavities are possible

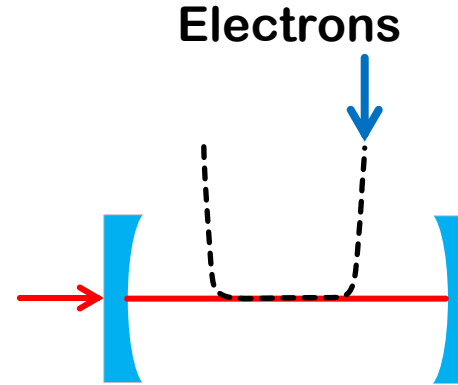

However, four mirror systems were found to be more practical, and in particular more stable to disturbances

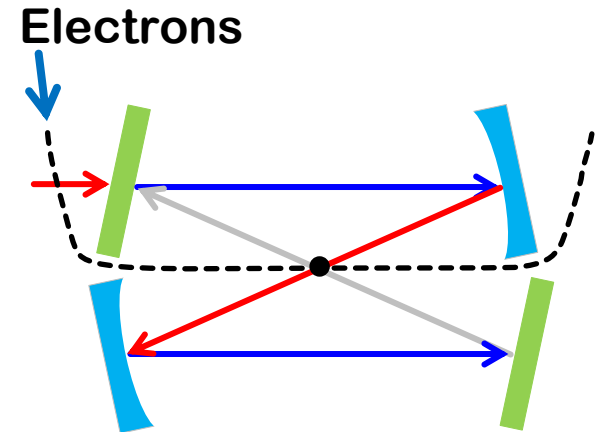
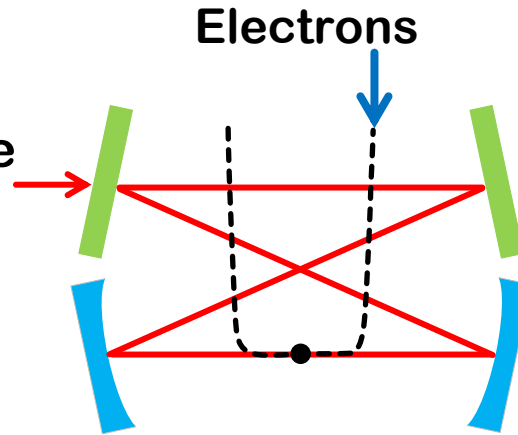

Laser pulses combination

- For high rep rate LWFA need high average and high peak power lasers e.g. 10 kHzs for colliders, > kHz for medical/light source applications.
- Problem with current solid state laser systems (e.g. Ti:sapp, Nd:glass) – high energy/short pulses BUT very low rep rate (1 shot/hr – 1Hz).
- Massively electrically inefficient (< 0.01%) – too expensive to run!
- Fibre lasers! – optical waveguide, good thermal properties, efficient.

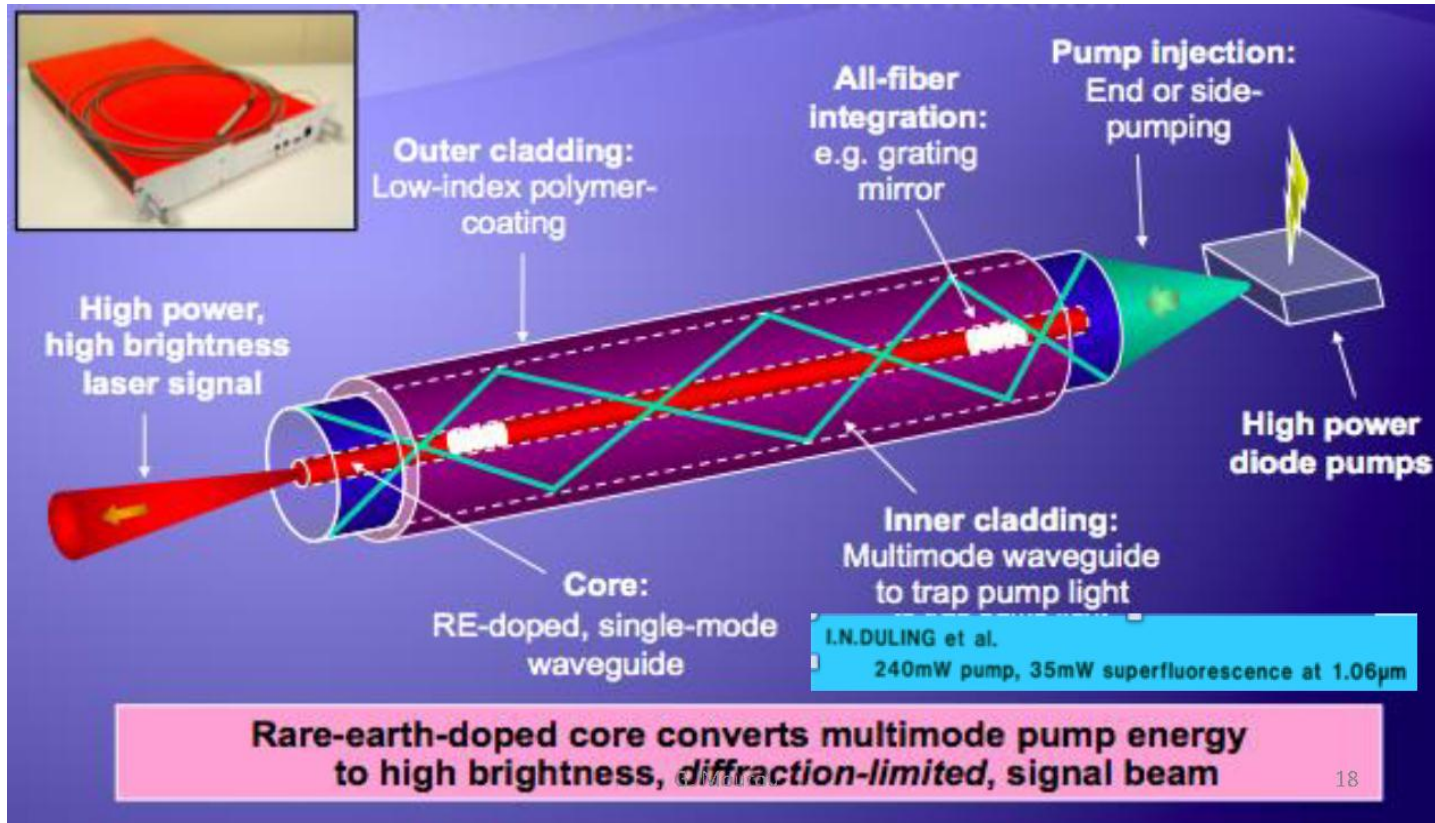

Laser pulses combination

- Commercial fiber lasers reach 100 kW in CW
- Wall plug efficiency > 40%
- Photo below is from IPG Photonics



ICAN and laser combination



ICAN – International Coherent Amplification Network

Research on combining many fibre lasers (short pulses!) together for high rep rate, high energy laser systems.

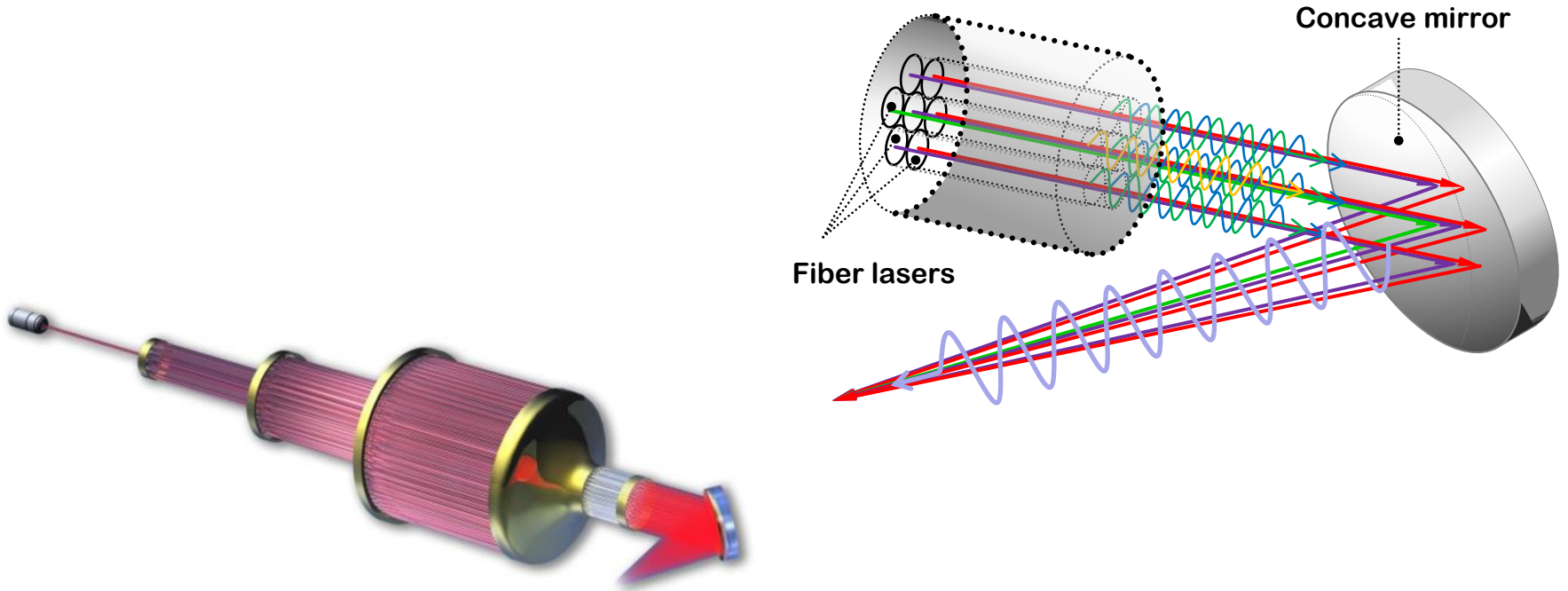

Phase control and combine 100s – 1000s fibres

“The future is fibre accelerators”, Gerard Mourou, Bill Brocklesby, Toshiki Tajima & Jens Limpert, Nature Photonics 7, 258–261 (2013)

ICAN and laser combination

- Parallel or serial combining

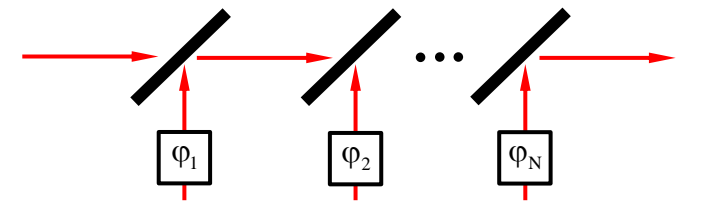
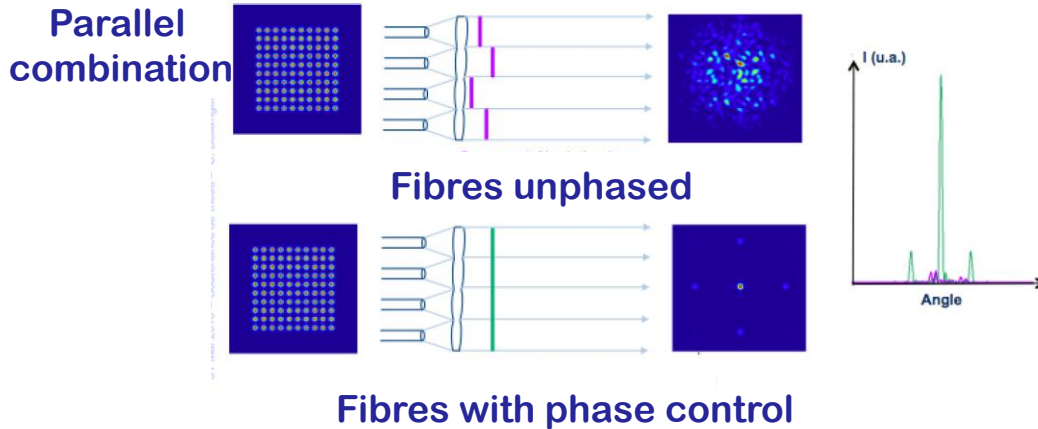

Serial polarisation combination

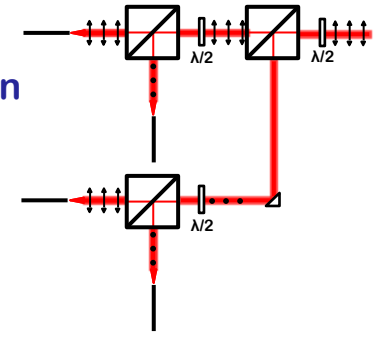

- Need to lock phases of beams.
- Can't completely fill aperture.
- → intrinsic sidelobes.

- Need to lock phases of beams.
- Requires good spatial overlap.
- Hard to scale?

“Collective coherent phase combining of 64 fibers”,
J.Bouderionnet, Op. Exp. 19, 17053 (2011)

“4 channel coherently combined fs fiber CPA system”,
A.Klenke, Opt. Letts 38, 2283 (2013)

Pictures: T. Schreiber, A. Brignon

How to focus to a smallest size and how big is chromaticity in FF?

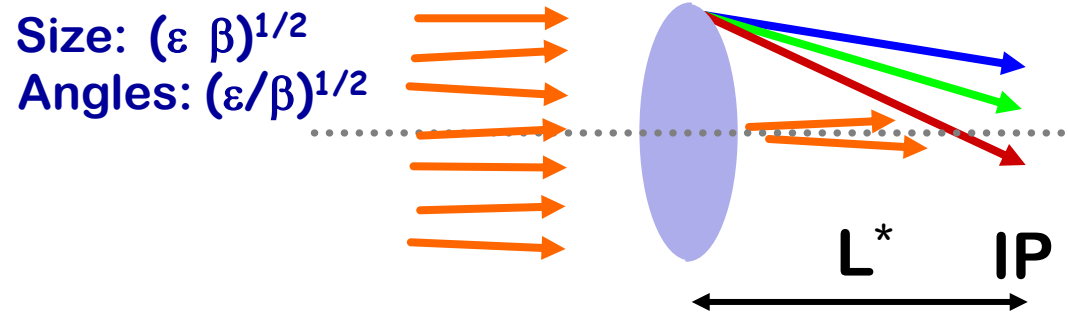

- The final lens need to be the strongest
 - (two lenses for both x and y => “Final Doublet” or FD)
- FD determines chromaticity of FF
- Chromatic dilution of the beam size is $\Delta\sigma/\sigma \sim \sigma_E L^*/\beta^*$

Typical: σ_E -- energy spread in the beam $\sim 0.002-0.01$
 L^* -- distance from FD to IP $\sim 3 - 5$ m
 β^* -- beta function in IP $\sim 0.4 - 0.1$ mm

- For typical parameters, $\Delta\sigma/\sigma \sim 15-500$ **too big !**
- => **Chromaticity of FF need to be compensated**

FF with non-local chromaticity compensation

- Chromaticity is compensated by sextupoles in dedicated sections
- Geometrical aberrations are canceled by using sextupoles in pairs with $M = -1$

Chromaticity arise at FD but pre-compensated 1000m upstream

Problems:

- Chromaticity not locally compensated
 - Compensation of aberrations is not ideal since $M \neq -1$ for off energy particles
 - Large aberrations for beam tails
 - ...

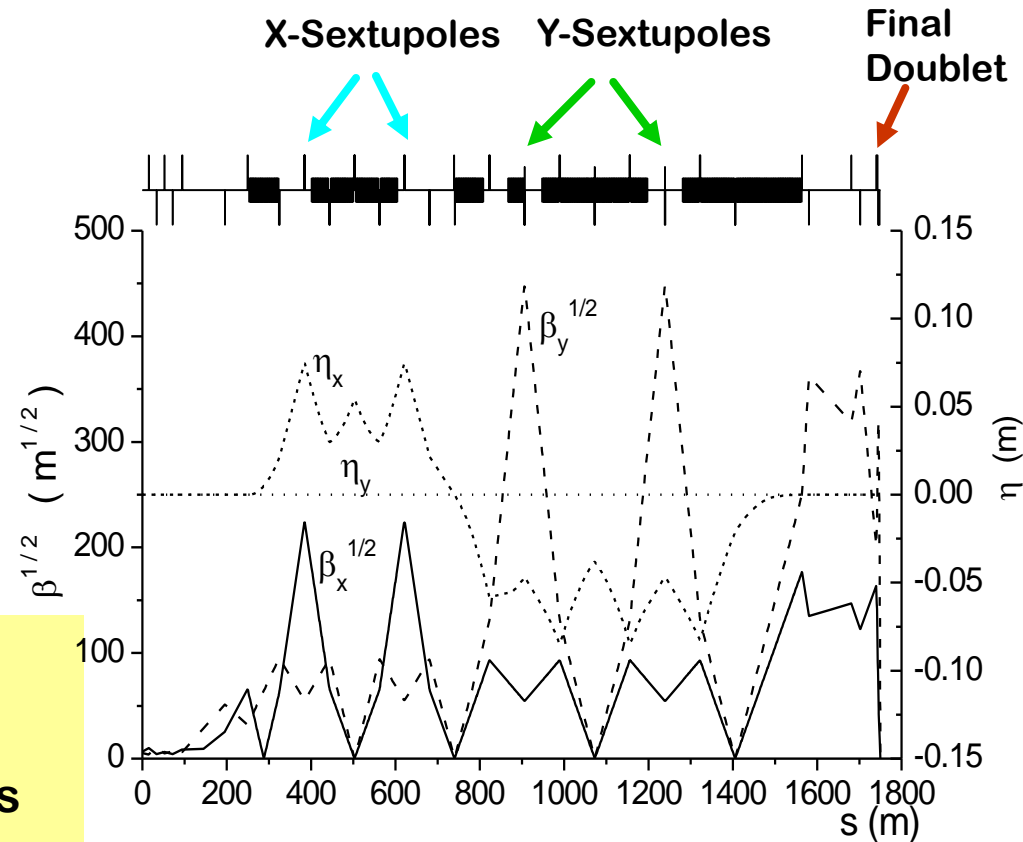

Traditional FF

Local chromatic correction

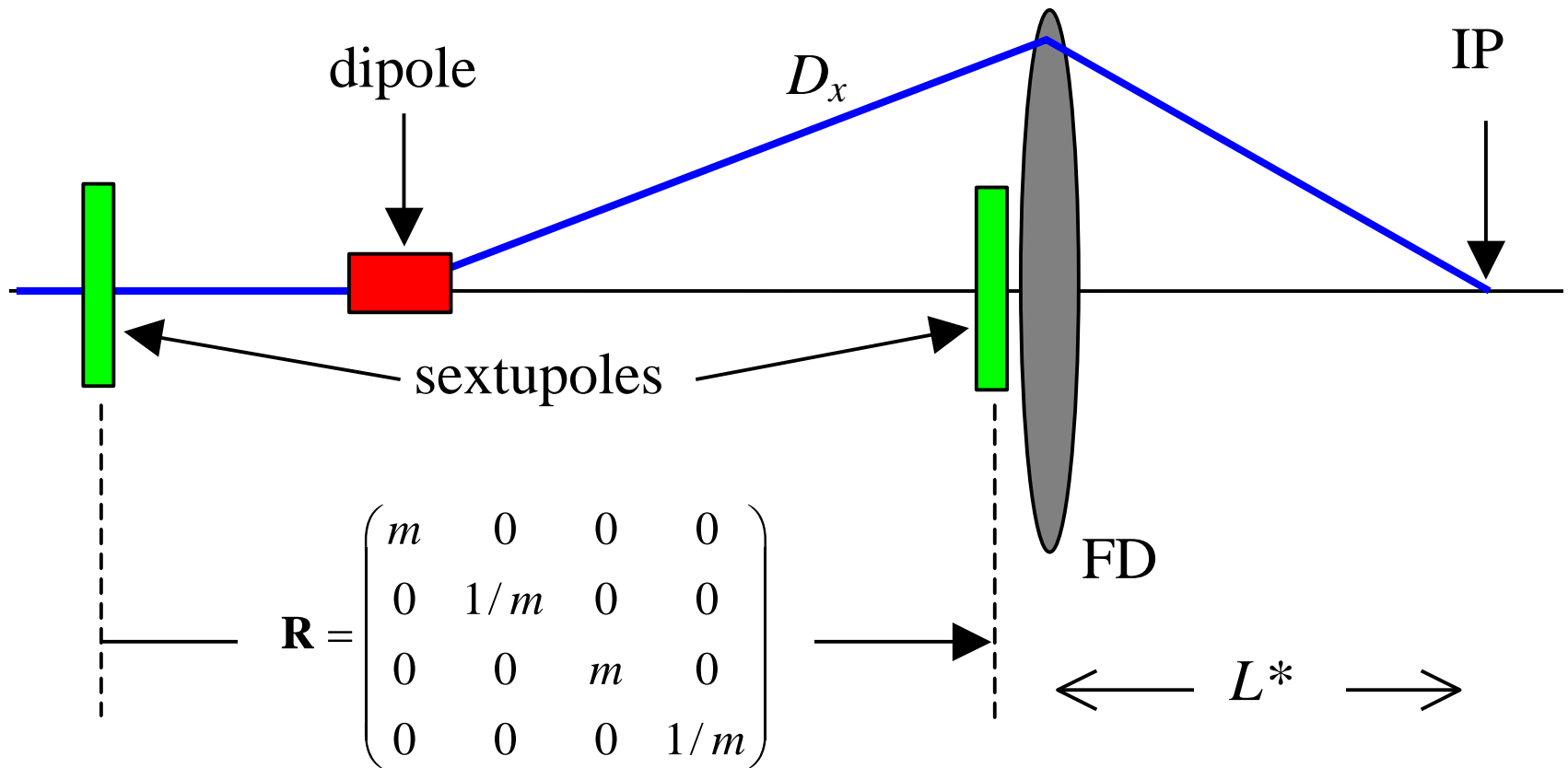

- The value of dispersion in FD is usually chosen so that it does not increase the beam size in FD by more than 10-20% for typical beam energy spread

Compact FF

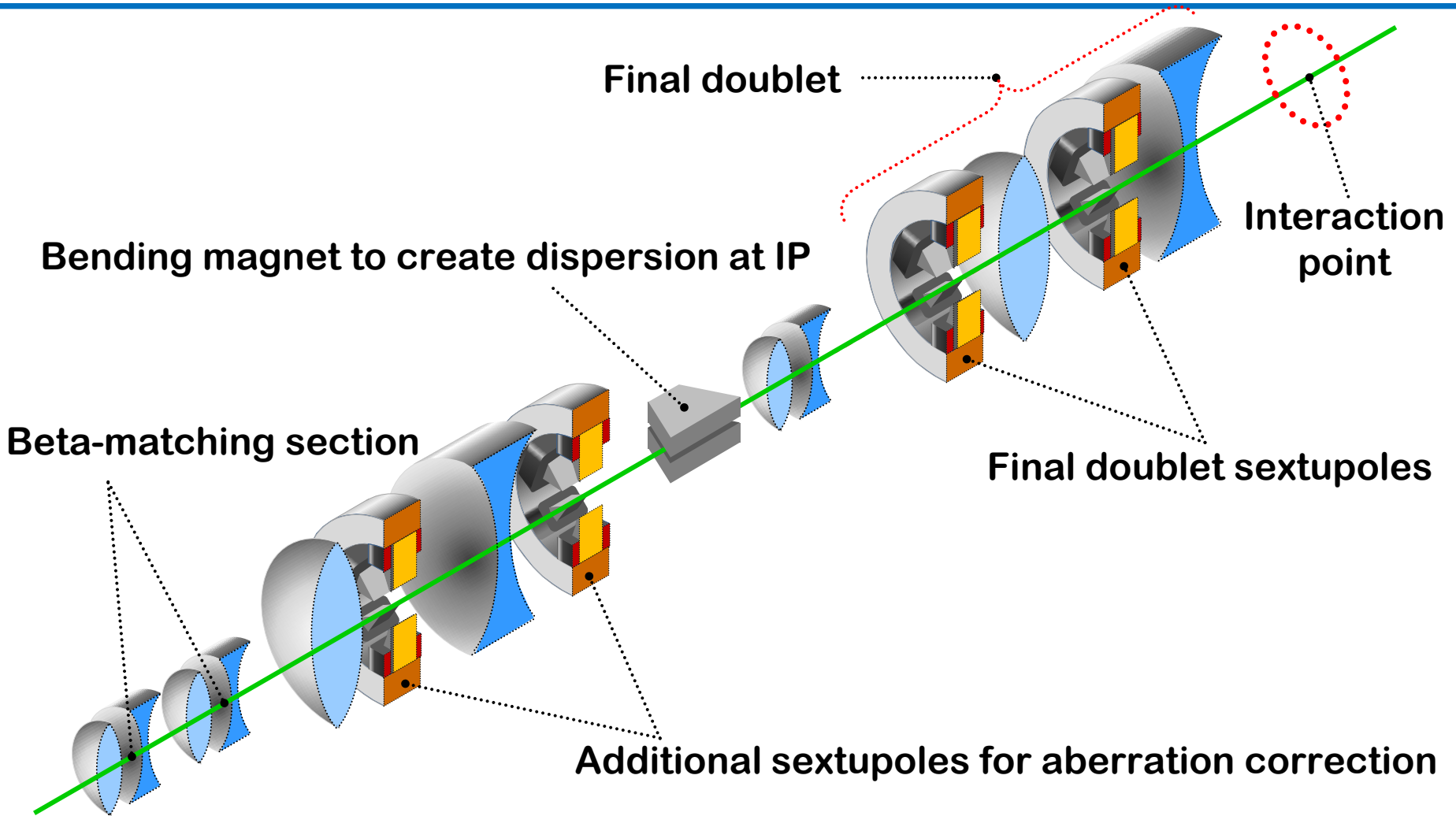

Compare FF designs

FF with local chromaticity compensation with the same performance can be ~300m long, i.e. 6 times shorter

Moreover, its necessary length scales only as $E^{2/5}$ with energy! One can design multi-TeV FF in under a km!

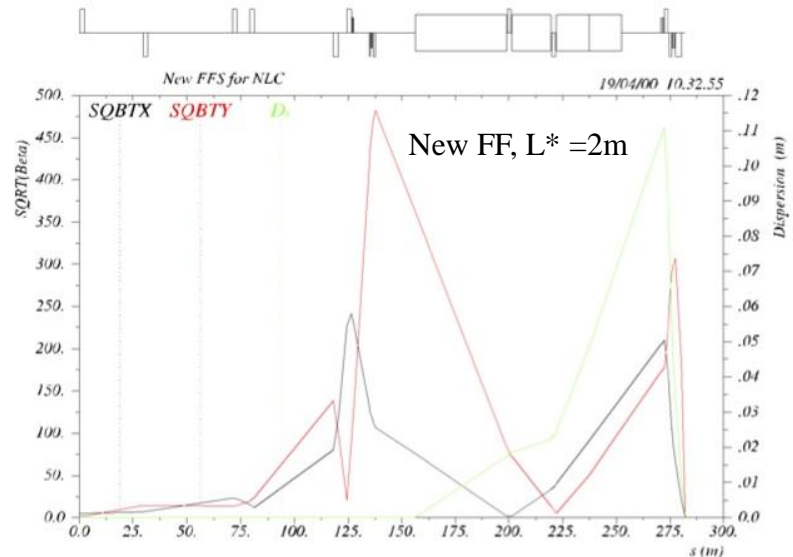
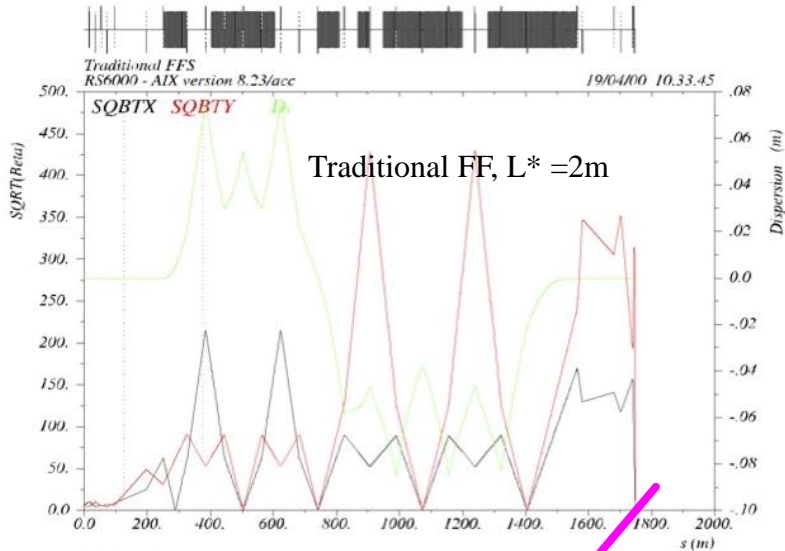

new FF

Crab crossing

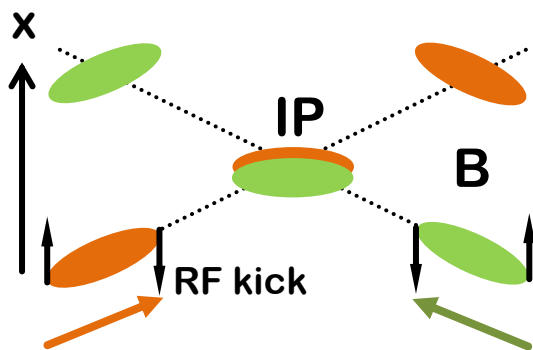
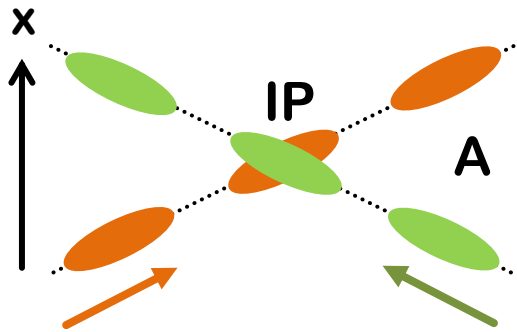

Use transverse (crab) RF cavity to 'tilt' the bunch at IP

With crossing angle q_c , the projected x-size is $(s_x^2 + q_c^2 s_z^2)^{0.5} \sim q_c s_z \sim 4\text{mm}$

→ several time reduction in L without corrections

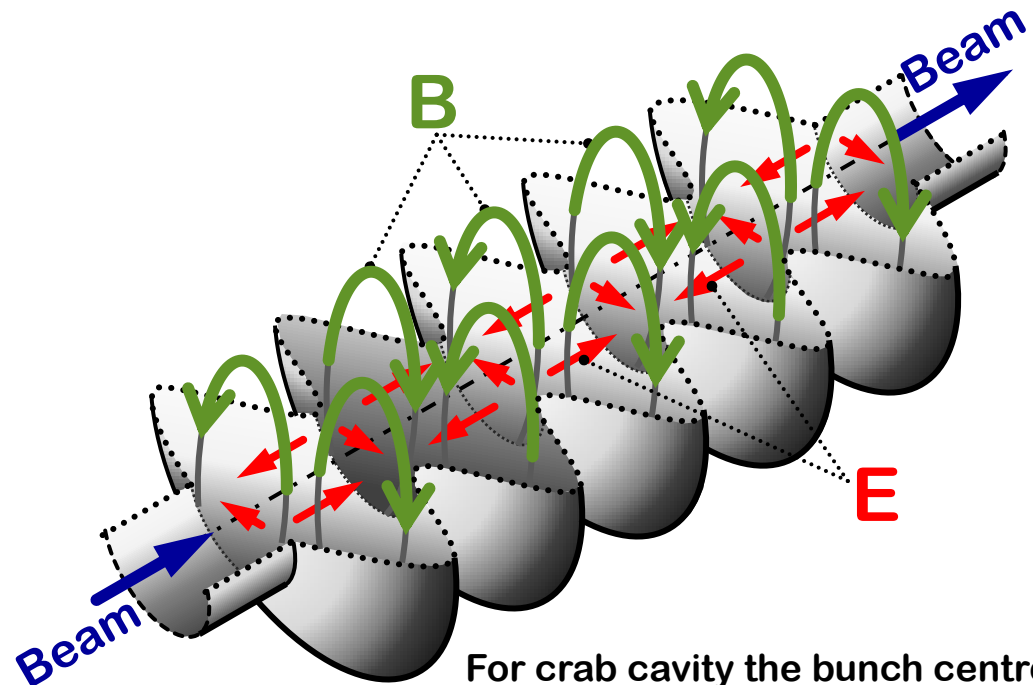

For crab cavity the bunch centre is at the cell centre when **E** is maximum and **B** is zero

IR coupling compensation

When detector solenoid overlaps QD0, coupling between y & x' and y & E causes large (30 – 190 times) increase of IP size (green=detector solenoid OFF, red=ON)

Even though traditional use of skew quads could reduce the effect, the local compensation of the fringe field (with a little skew tuning) is the most efficient way to ensure correction over wide range of beam energies

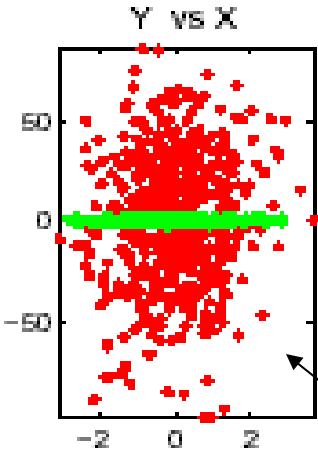

without compensation
 $\sigma_y / \sigma_y(0) = 32$

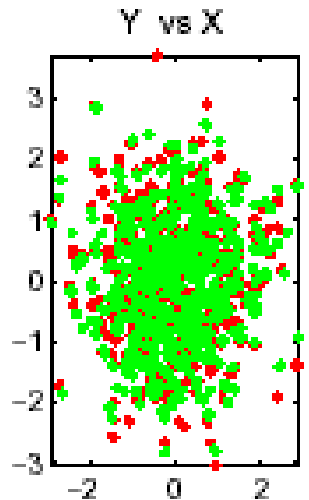

with compensation by antisolenoid
 $\sigma_y / \sigma_y(0) < 1.01$

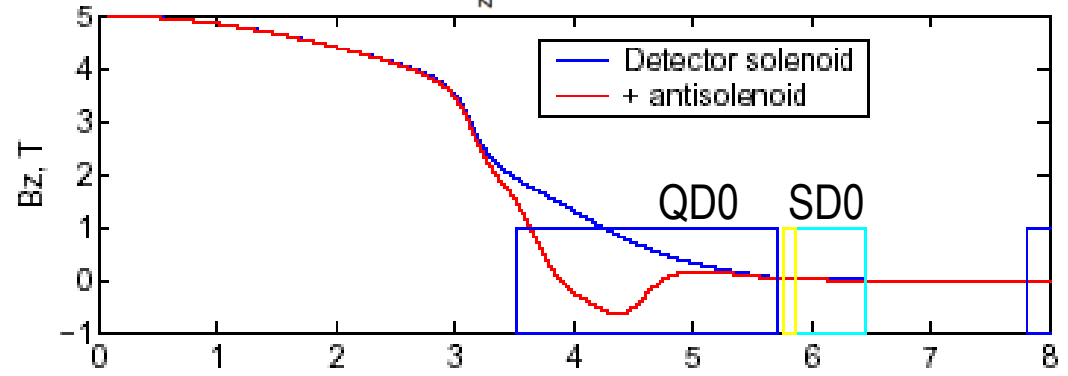
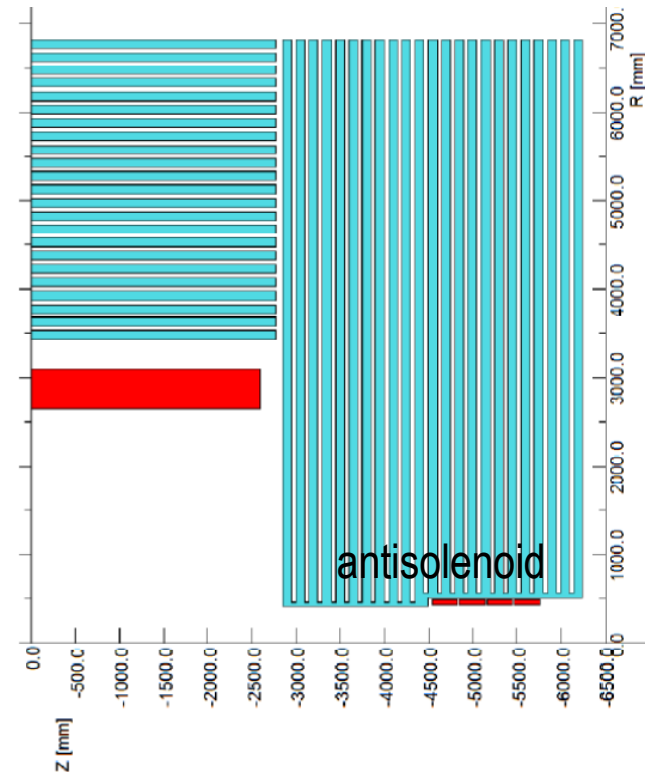

ILC Interaction Region...

Focusing quads are located just few cm away from each other, and their external field will affect the other beam

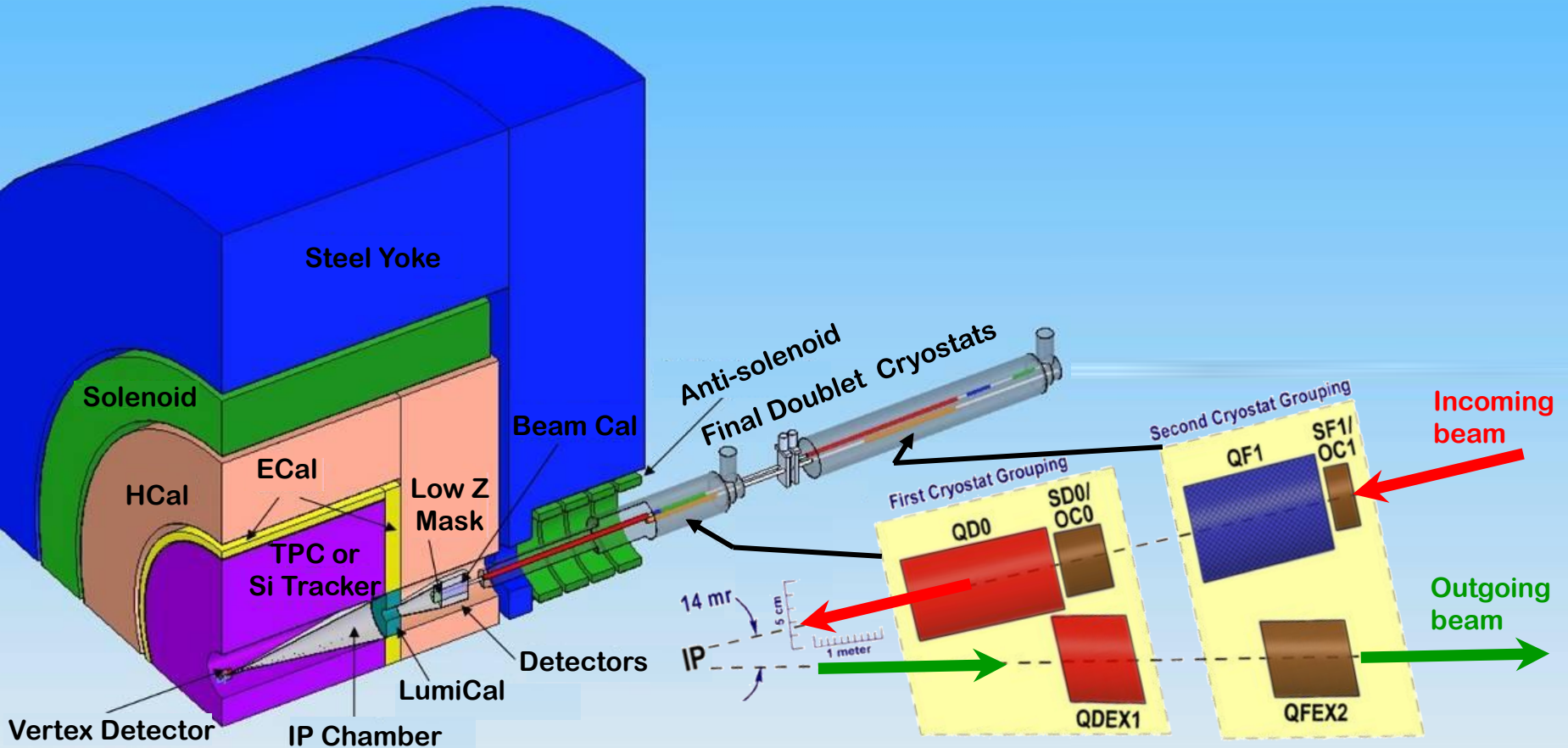

ILC Interaction Region...

Cross-talk of focusing quads is avoided by use of active shielding by a winding of opposite polarity

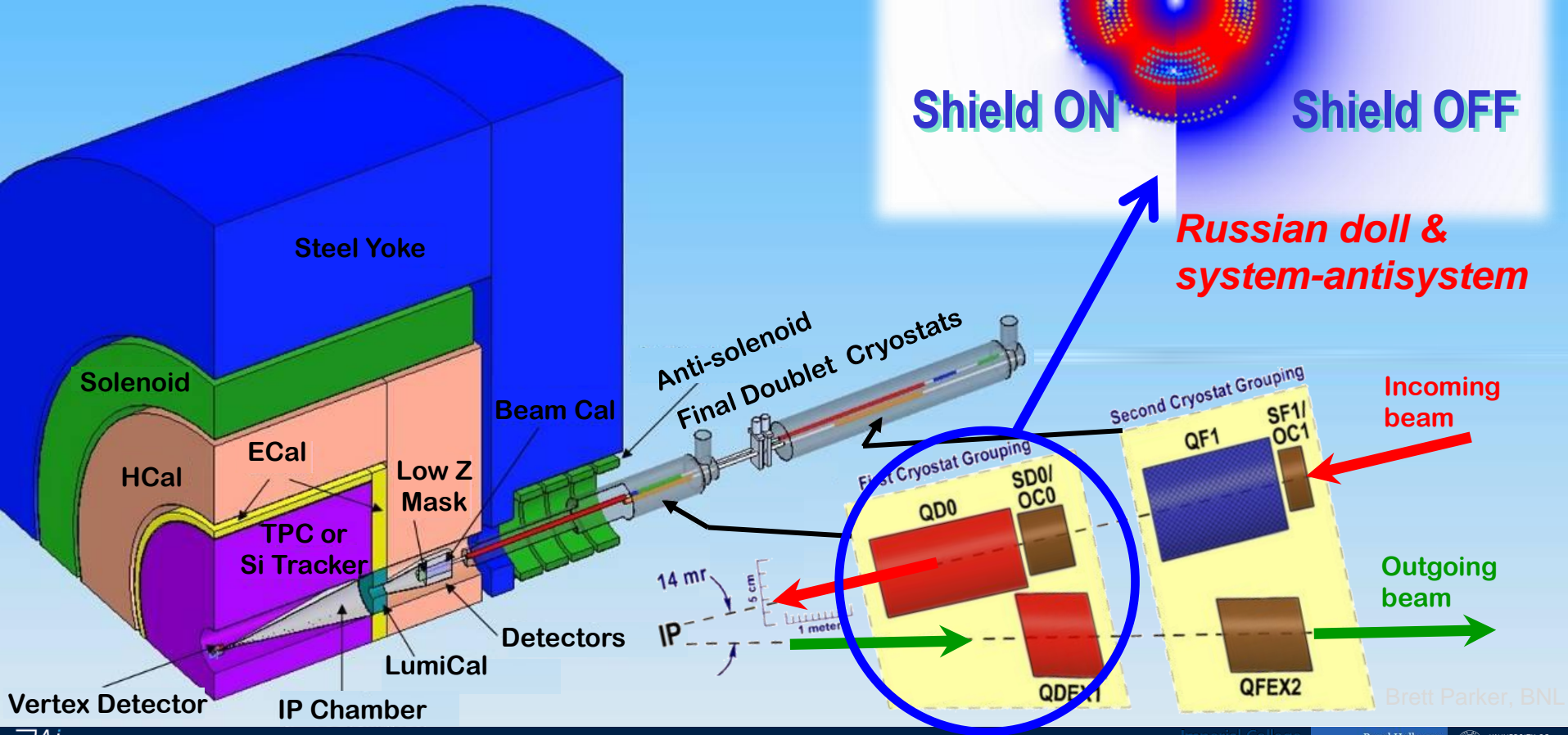

Actively shielded QD0

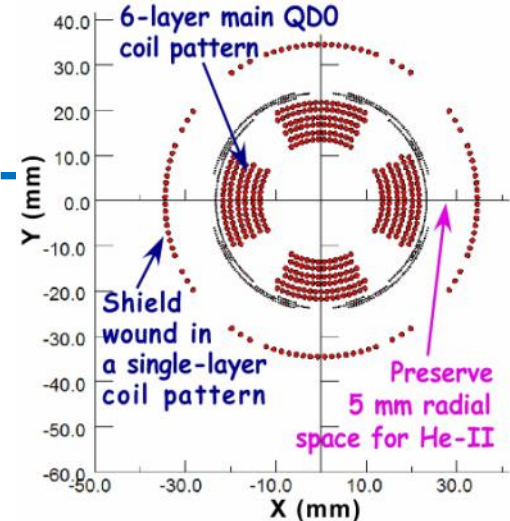

BNL

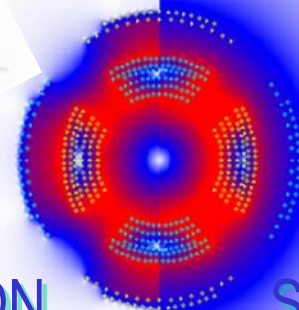

Shield ON

Shield OFF

Intensity of color represents value of magnetic field.

force neutral antisolenoid

Two Coils; Different Radii

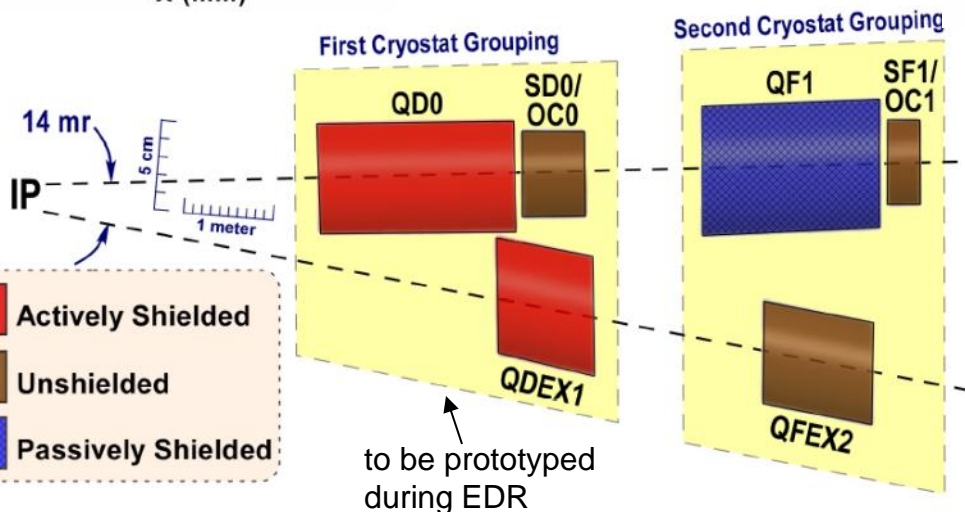
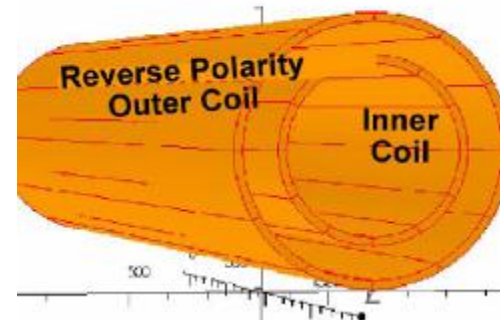

- Interaction region uses compact self-shielding SC magnets
- Independent adjustment of in- & out-going beamlines
- Force-neutral anti-solenoid for local coupling correction

Summary of the lecture

- **Effects/techniques for creation of short pulses**
 - **Bunch compression and Coherent Synchrotron Radiation**
 - **Q-switching techniques**
- **Addition of beams for higher intensity**
 - **Beam injection techniques**
 - **Laser cavities**
 - **Coherent addition of laser pulses & ICAN**
- **Focusing the beams to small size**
 - **Final focus for beams**