

CAVITY FABRICATION

Gianluigi Ciovati

Thomas Jefferson National Accelerator Facility

Outline

- Nb production for SRF cavities fabrication
- Standard cavity fabrication:
 - Deep drawing
 - Electron beam welding
- Cavity fabrication R&D:
 - Large-grain/single crystal Nb
 - Hydroforming
 - Spinning

Nb = SRF

- Niobium is the material of choice to fabricate SRF cavities:
 - High critical temperature ($T_c = 9.25\text{K}$)
 - High critical field ($H_c(0\text{K}) \cong 200\text{mT}$)
 - Chemically inert (surface covered by oxide layer)
 - Easily machined and deep drawn
 - Available as bulk and sheet material in any size



Niobium, Brief History

- Named after *Niobe* (daughter of Tantalus, Greek mythology)
- Discovered in **1801** by Charles Hatchett in England from a columbite ore from Connecticut. He called it *Columbium*



Niobium, Brief History

- It was confused with tantalum until 1846, when it was re-discovered by Heinrich Rose and Jean Charles Galissard de Marignac, who called it *Niobium*
- “Niobium” was officially adopted as the name for the element 41 in 1950
- It was found to be a **superconductor** (zero electrical resistance) in the 1920s

Niobium Production

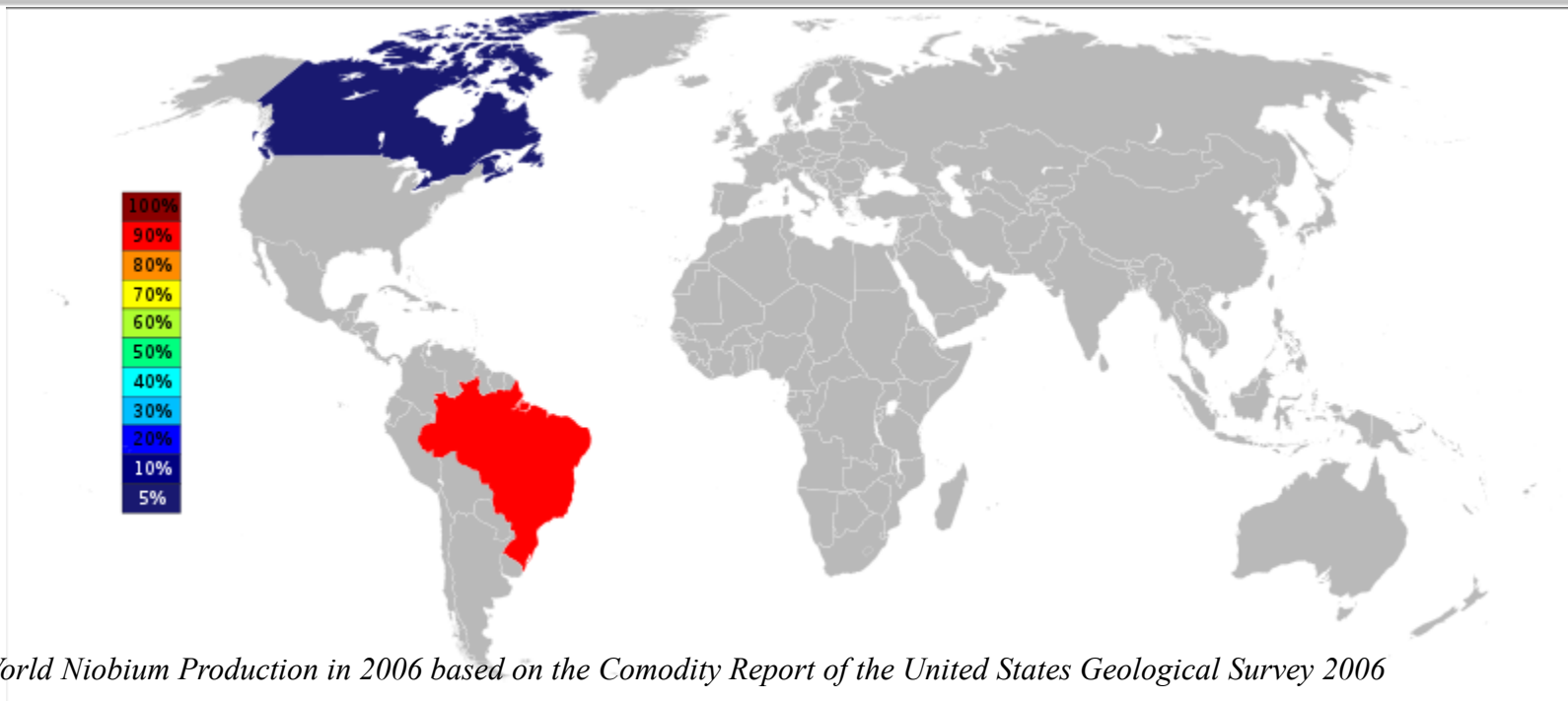

Niobium is mostly obtained from mineral known as **pyrochlore** ($\text{NaCaNb}_2\text{O}_6\text{F}$). The pyrochlore mineral is processed to give a concentrate ranging from 55 to about 60% niobium oxide (Brazil, CBMM).

Columbite ($(\text{Fe}, \text{Mn})(\text{Nb}, \text{Ta})_2\text{O}_6$), a mineral with a ratio of $\text{Nb}_2\text{O}_5:\text{Ta}_2\text{O}_5$ ranging from 10:1 to 13:1, occurs in Brazil, Nigeria, and Australia, also other countries in central Africa. Niobium is recovered when the ores are processed for tantalum.

Niobium mines



The world's largest niobium deposits are located in Araxá, Brazil owned by Companhia Brasileira de Metalurgia e Mineração (CBMM). The reserves are enough to supply current world demand for about 500 years, about 460 million tons. The mining of weathered ore, running between 2.5 and 3.0% Nb_2O_5 , is carried out by open pit mining without the need for drilling and explosives. Approximately 85 to 90% of the niobium industry obtains its niobium ores.

Niobium Processing Plant



- CBMM Plant
- CBMM hosted the International Workshop on Single Crystal Niobium Technology in 2006

Nb Production (CBMM)

- Niobium Ore in Araxa mine (open air pit) is pyrochlor with 2.5% Nb_2O_5
- The ore is crushed and magnetite is magnetically separated from the pyrochlor.
- By chemical processes the ore is concentrated in Nb contents (50 –60 % of Nb_2O_5)
- A mixture of Nb_2O_5 and aluminum powder is being reacted to reduce the oxide to Nb
- This Nb is the feedstock for the EBM processes

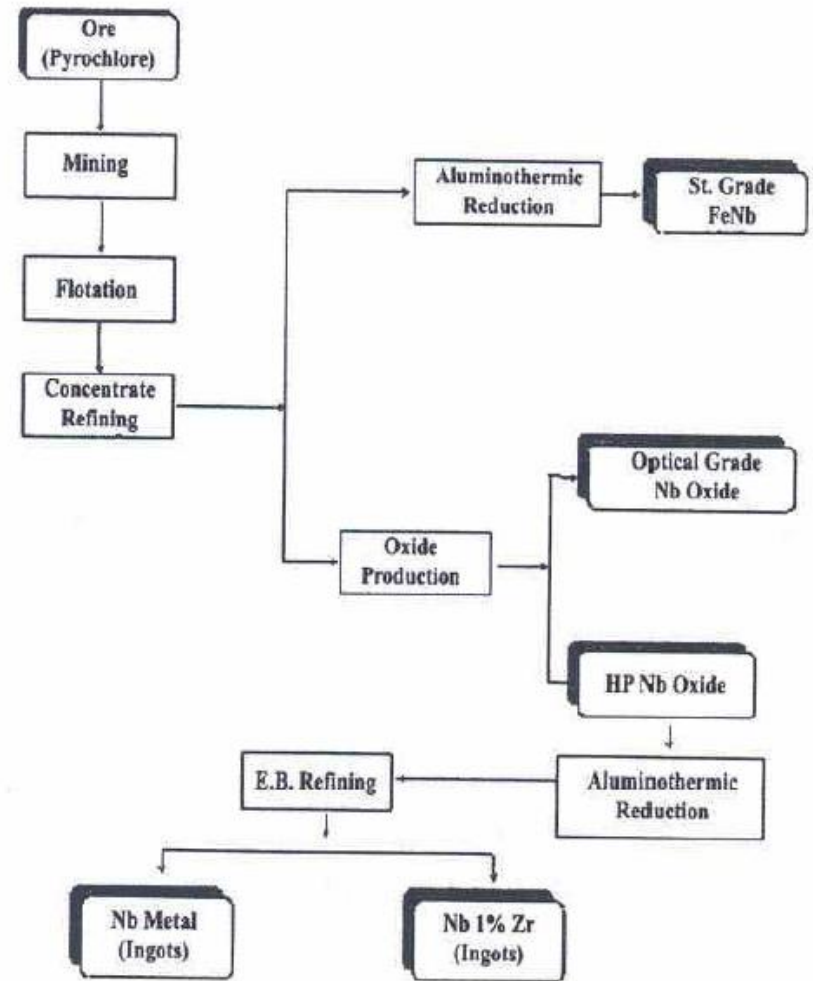
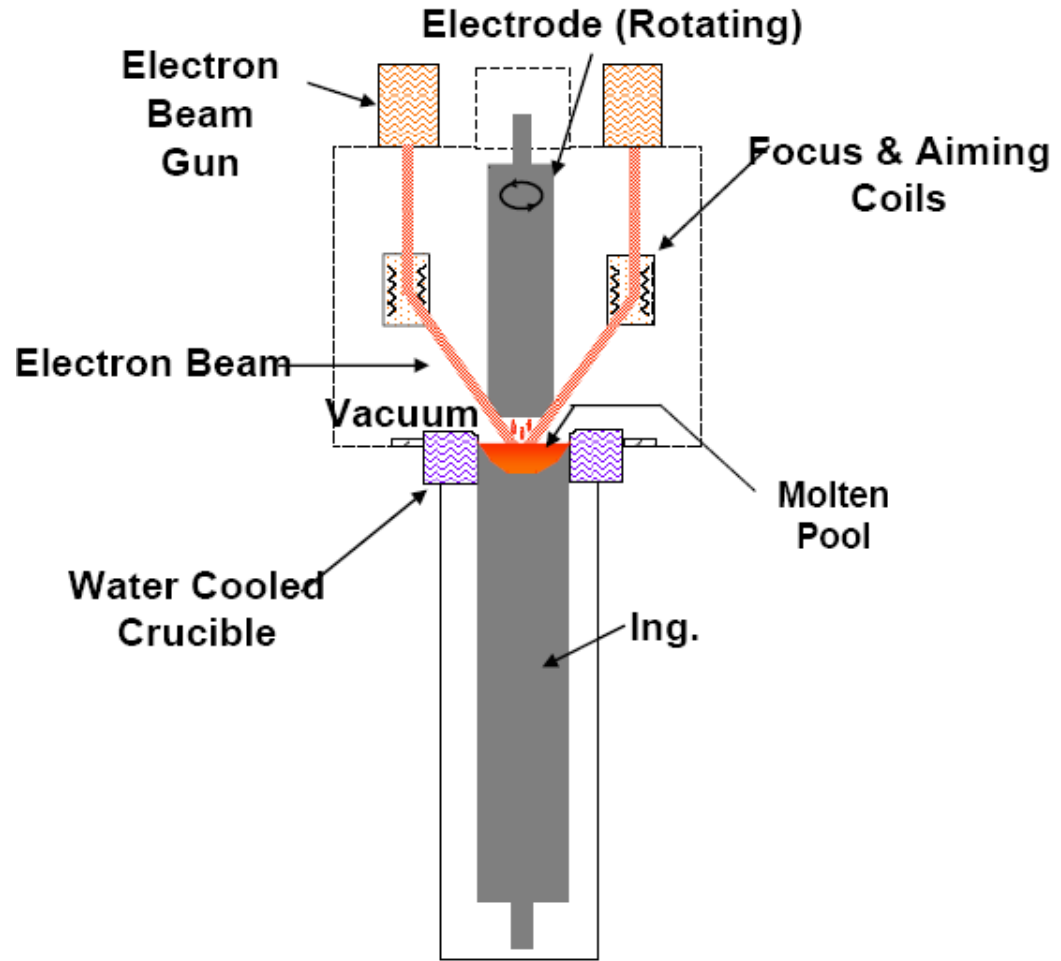

Fig. 3: Production flow chart at CBMM.

Electron Beam Melting

- Molten metal globules fall into a pool on the ingot which is contained in a water cooled copper cylinder (sleeve).
- Impurities are evaporated and pumped away.
- The pool is molten out to within a few mm of the crucible wall.
- During melting the ingot formed is continuously withdrawn through the sleeve.
- The rate of withdrawal has to be carefully coordinated with the rate of the material to insure complete melting of the feed material and proper outgassing.



Electron beam melting of Nb

Electron Beam Melting

- As a result of the increasing demand for refractory metals in the last few decades, the electron-beam furnace has been developed to a reliable, efficient apparatus for melting and purification.
- There are several companies, which can produce high purity refractory metals in larger quantities: WahChang (USA), Cabot (USA), W.C.Heraeus (Germany), Tokyo Denkai (Japan), OTIC (China), CBMM (Brasil), H.C. Starck (Germany, USA)



Electron Beam Refining Furnace

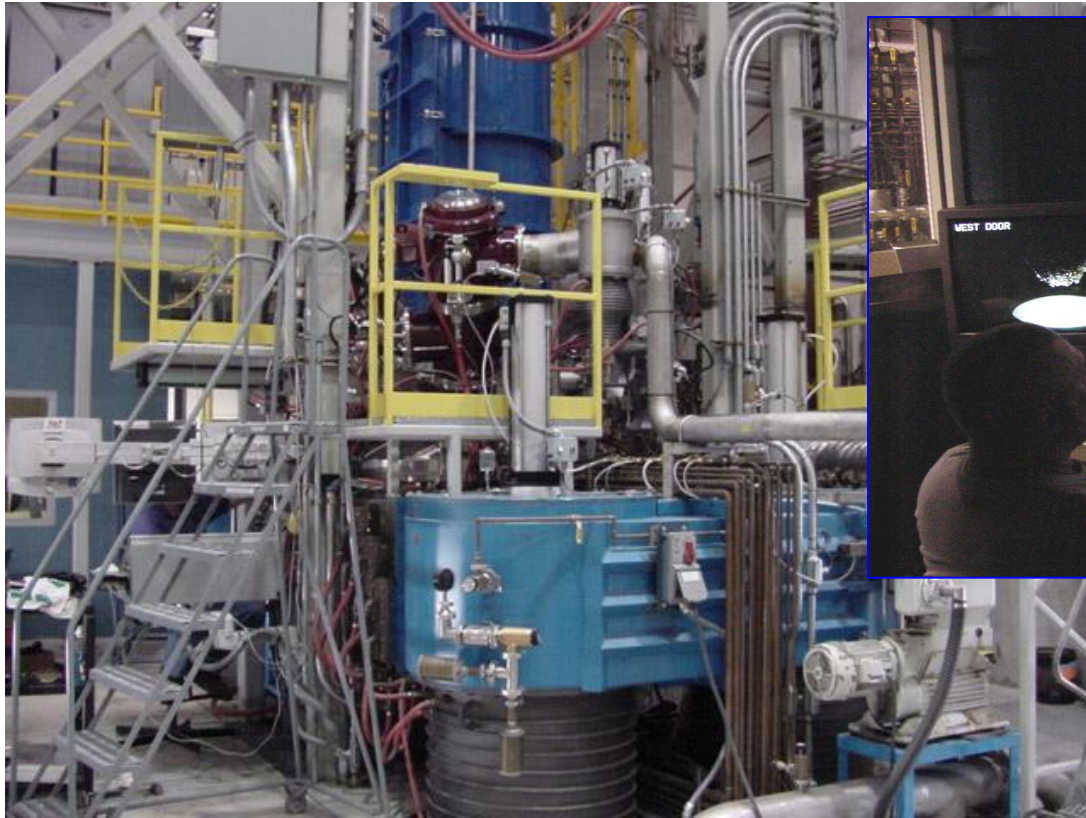

Furnace "S10" at ATI Wah Chang



- 4 900 mm diffusion pumps
- 200,000 l/sec
- 10^{-4} Torr
- 2,250 kW
- 3 EB guns
- Crucible diameter: 25-48 cm
- Ingot length: 2.9 m

Nb EB Refining

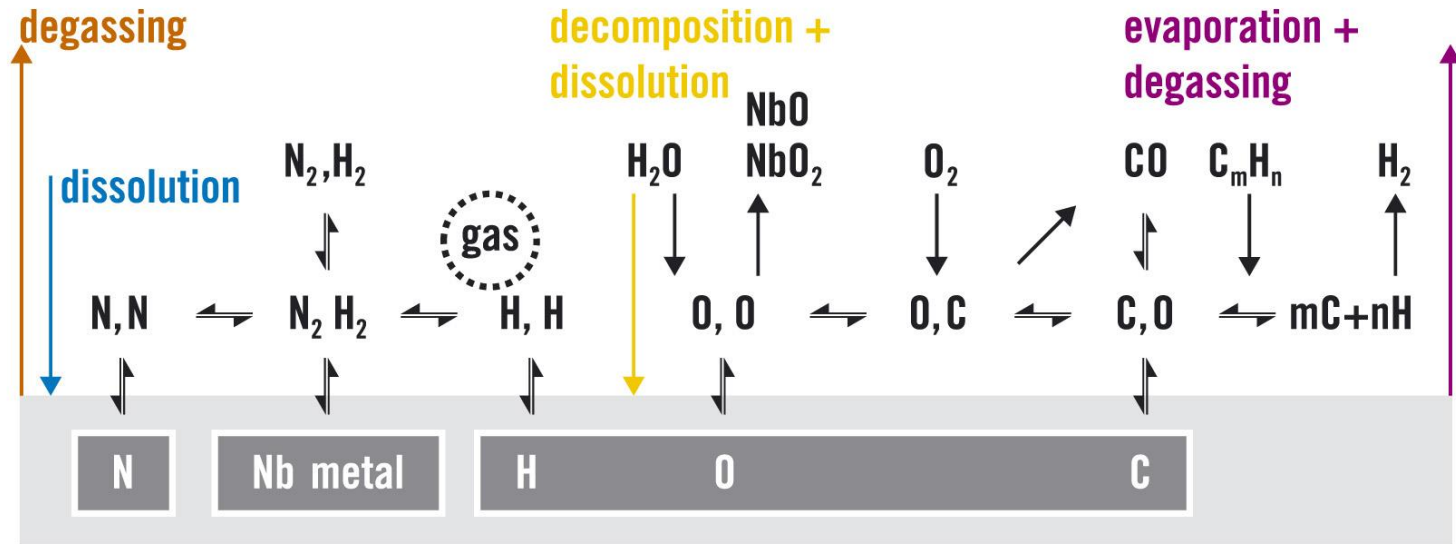

Metal-gas and gas-gas reactions during Nb EB refining

- The heating temperature is a compromise between the maximization of purification and minimization of the material losses by evaporation.
- RRR=300-500 are reachable currently.

Nb EB Refining

- One problem sometimes observed with e-beam melted ingots is the nonhomogeneous distribution of impurities.
- The **skin** of the ingot has been found to contain more impurities than the inside.
- **Top to bottom inhomogeneity** has also been observed. The first part of the melt which usually ends up at the bottom getters impurities in the early stages of the melt.
- Machining away the skin and cutting away a short section from the bottom are recommended for a purer final product

Niobium Ingot

Crucibles



Intermediate Ingot

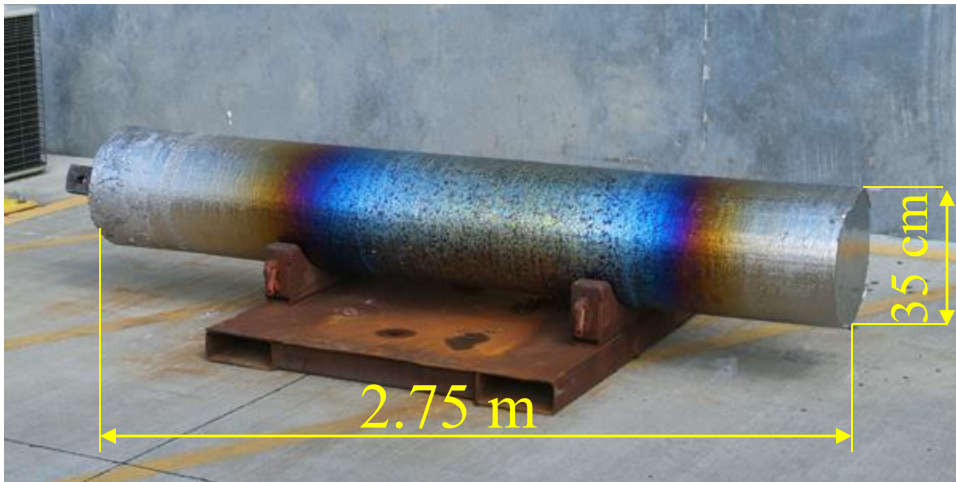

Fabrication of Fine-Grain Nb Sheets

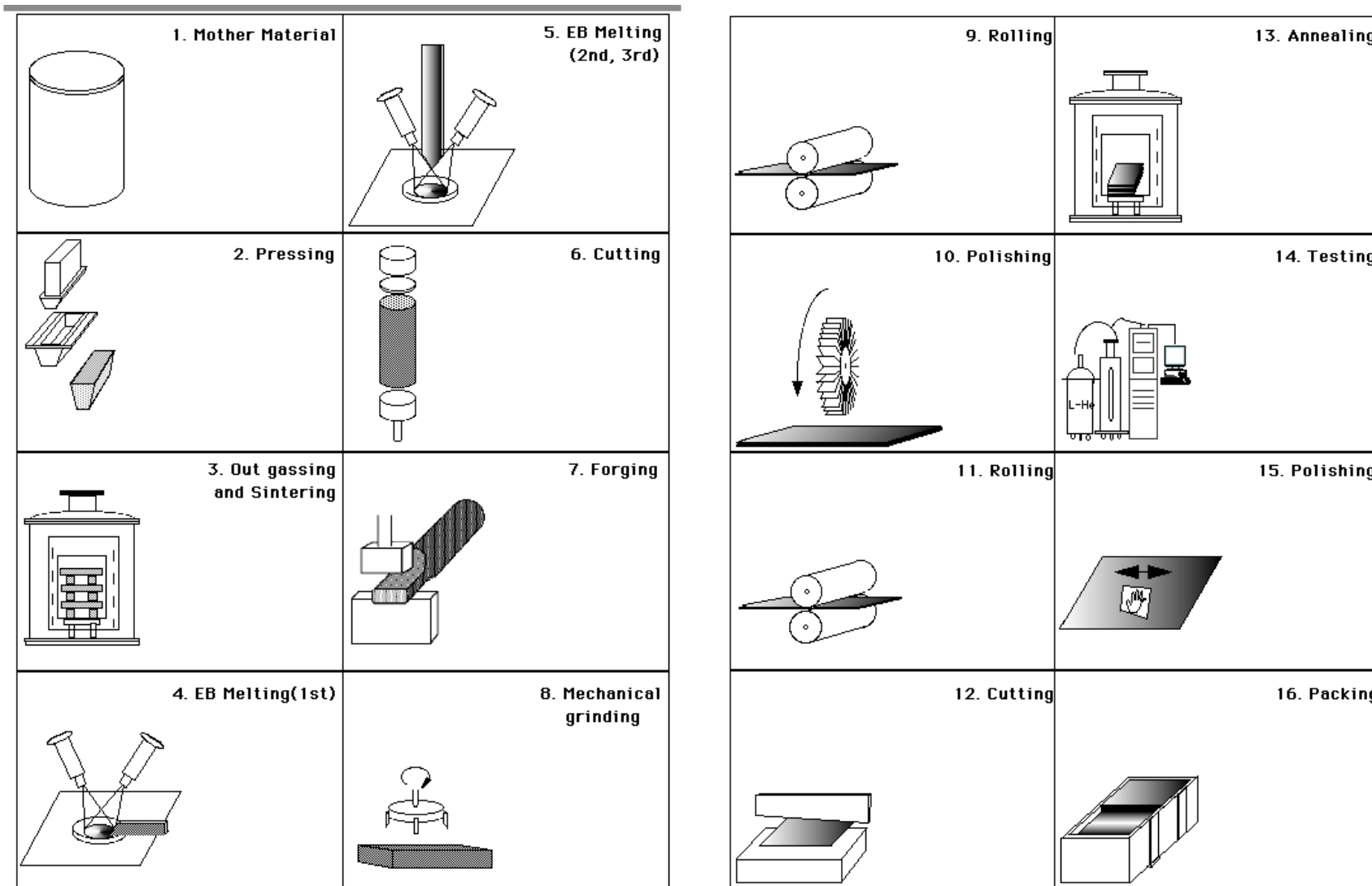

Forging

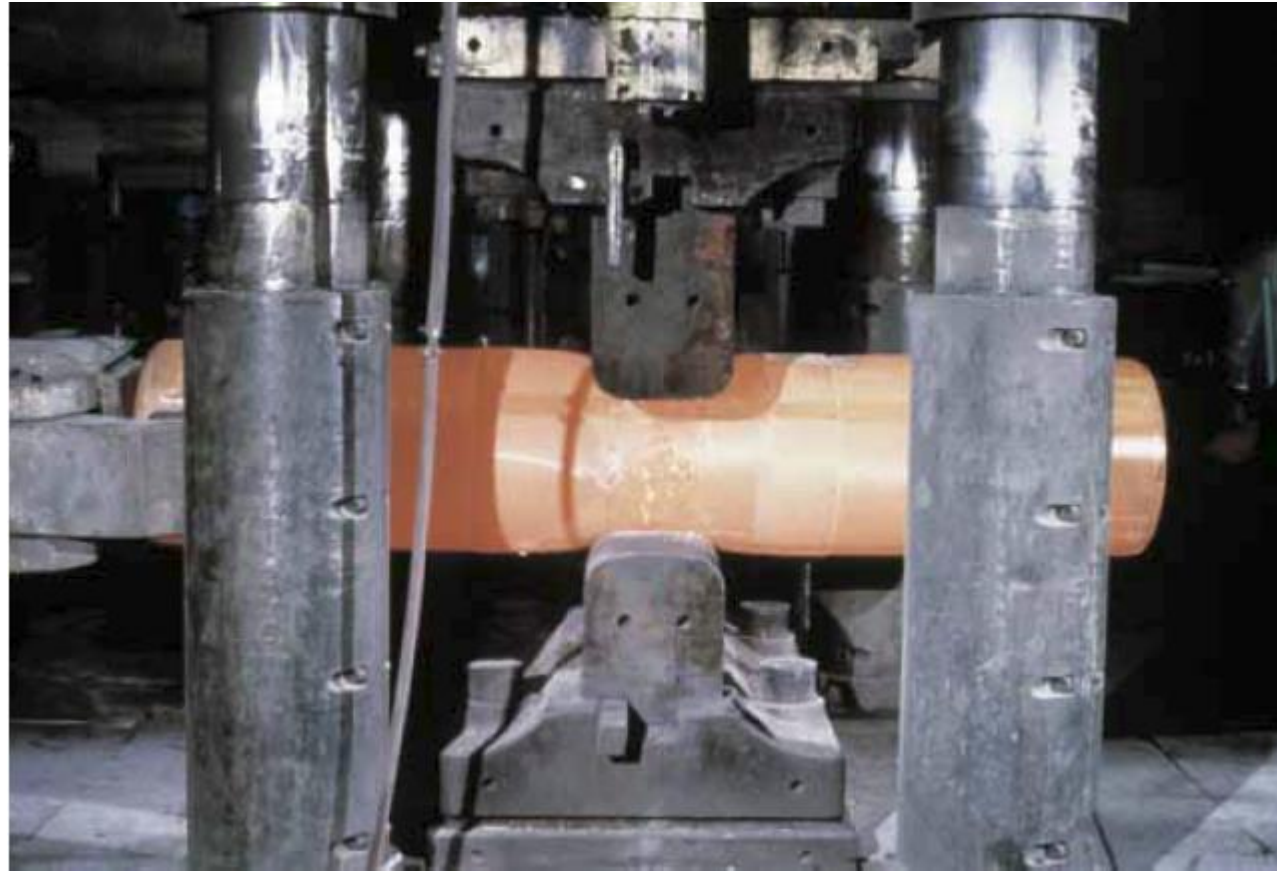
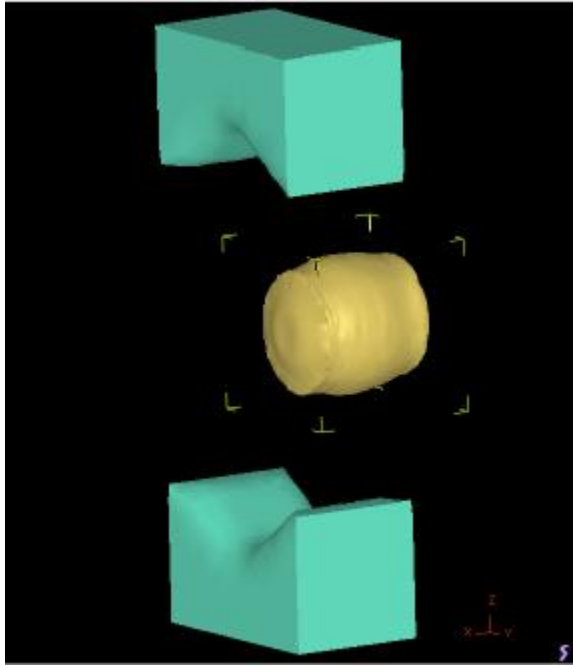

2000 ton open die forge (Wah Chang)

Rolling



700 mm wide cold rolling mill (Wah Chang)



800 mm wide hot rolling mill (Wah Chang)

Hot rolling, used mainly to produce sheet metal is when industrial metal is passed or deformed between a set of work rolls and the temperature of the metal is generally above its recrystallization temperature. Cold rolling takes place below recrystallization temperature.

Damage Layer by Rolling

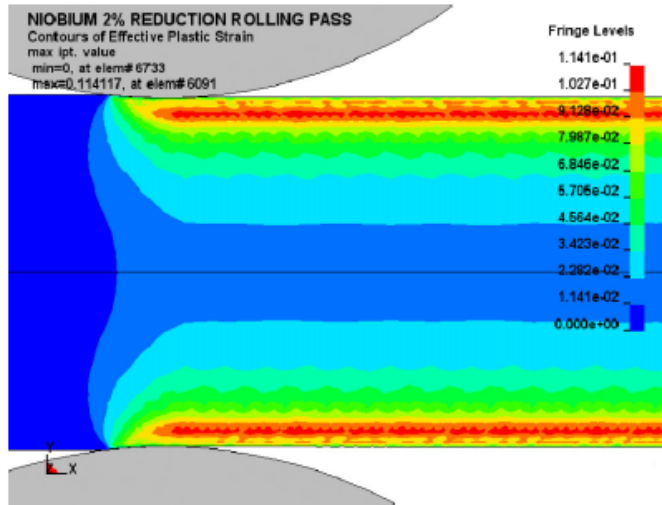

Finite element simulation of 2% reduction of 3.5 mm sheet with 1 cm diameter rolls. Strain is concentrated in the near-surface region

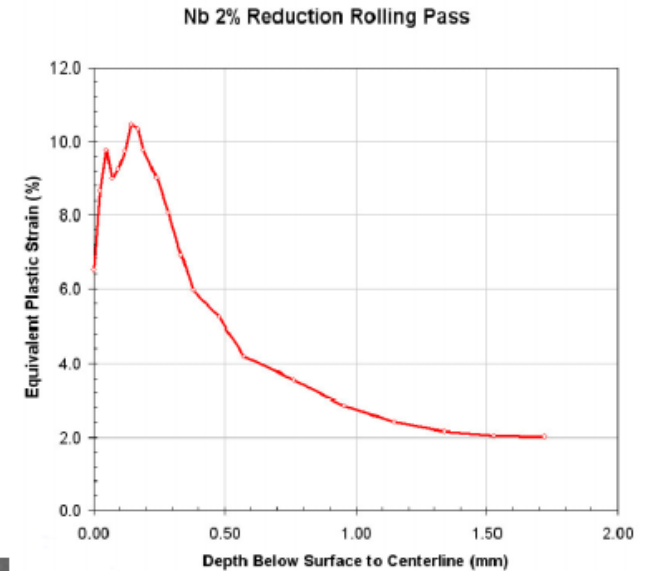

As-received RRR Nb Sheet,
20 μm below surface
(ion milled thin foil)

High dislocation density.

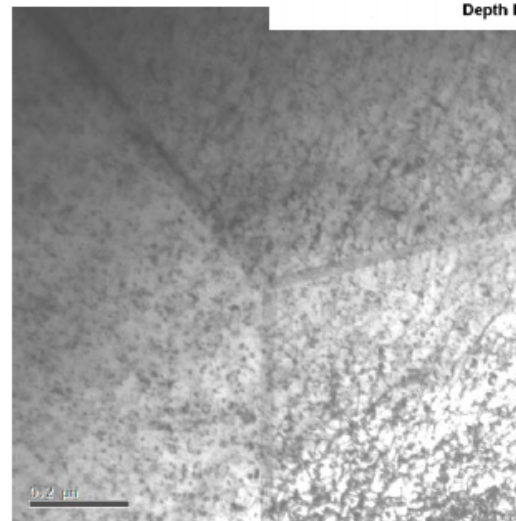

Transmission
electron
microscopy
image
(BFTEM)

Annealing

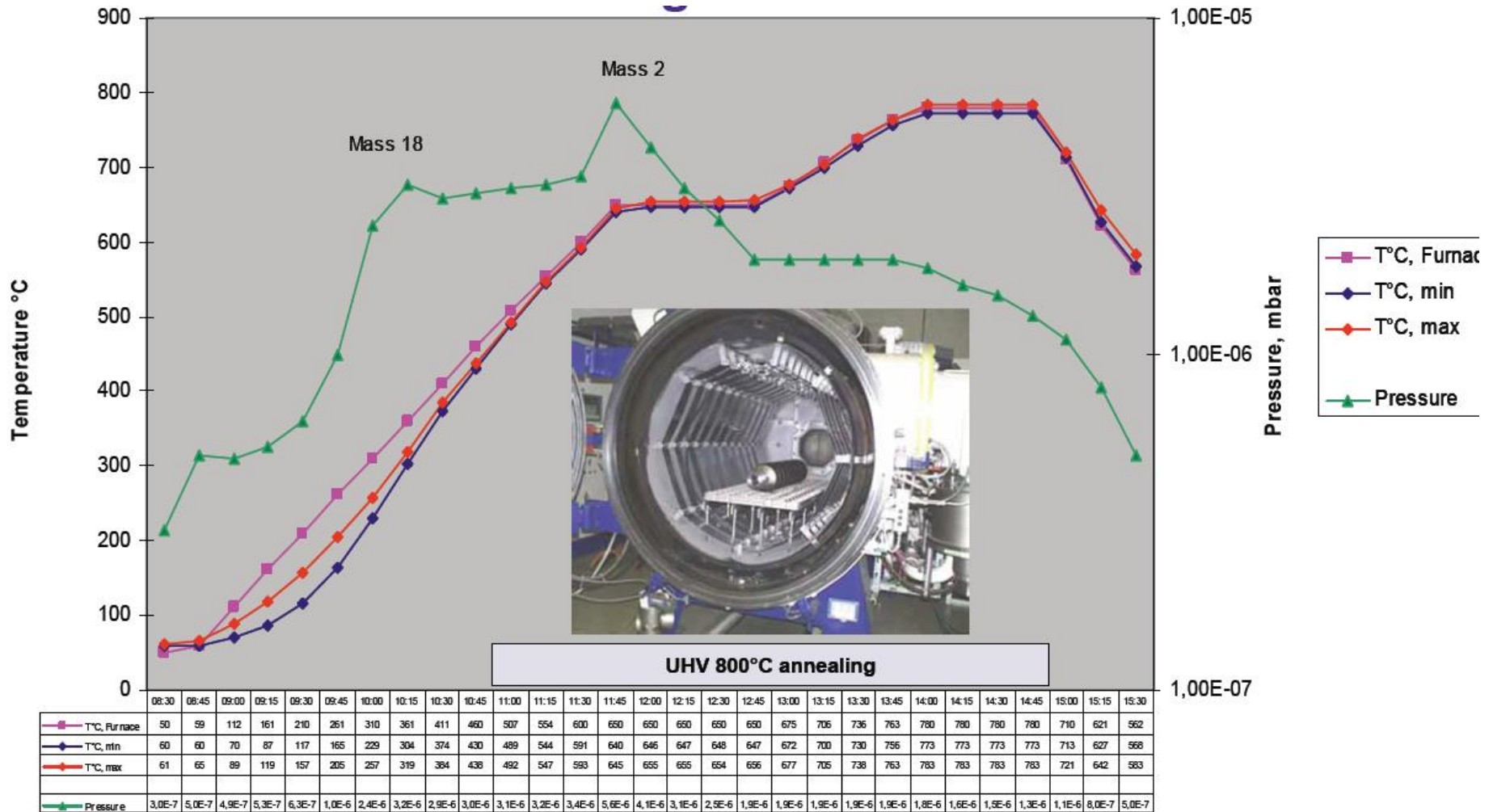

Annealing: recrystallization

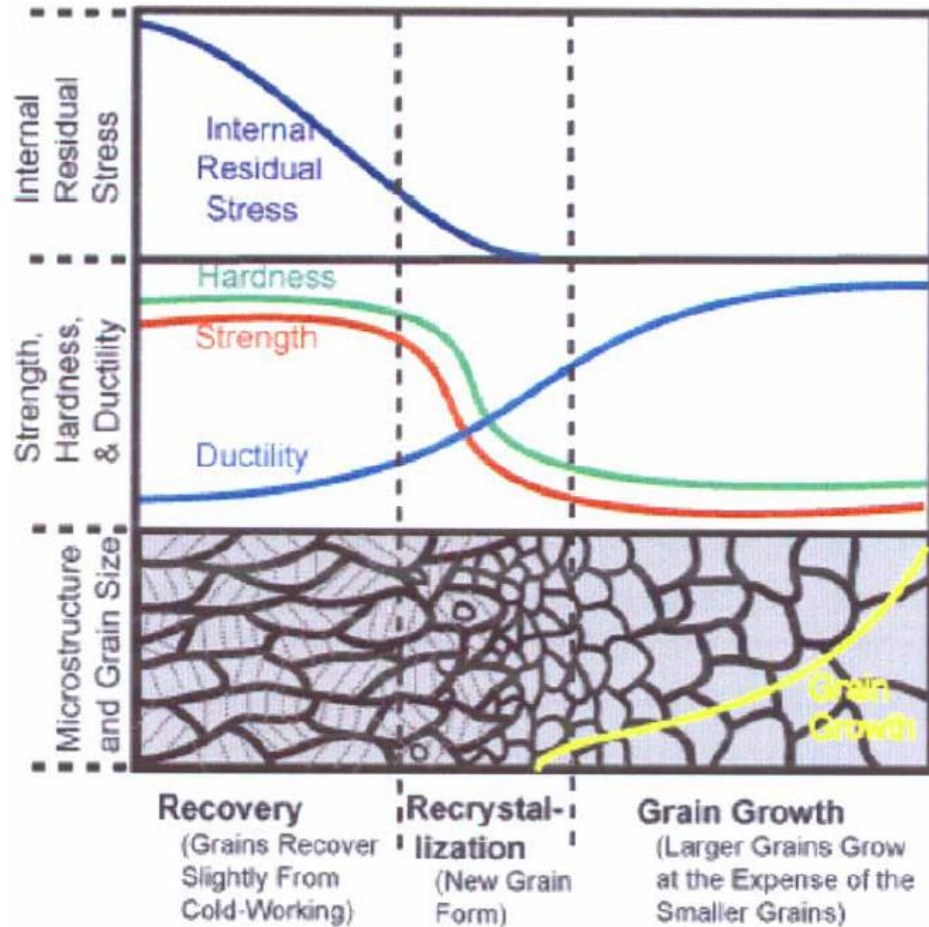

Choosing the proper annealing conditions is important to produce the correct grain size near 100% recrystallization and keep the highest possible purity (RRR).

Recovery: removing point defects, decrease and change direction of dislocations

Recrystallization: nucleation of new grains and growing of new crystals

Grain growth: increase in grain size

Recrystallization

Commercial "Pure Nb"
RRR ~ 50-100

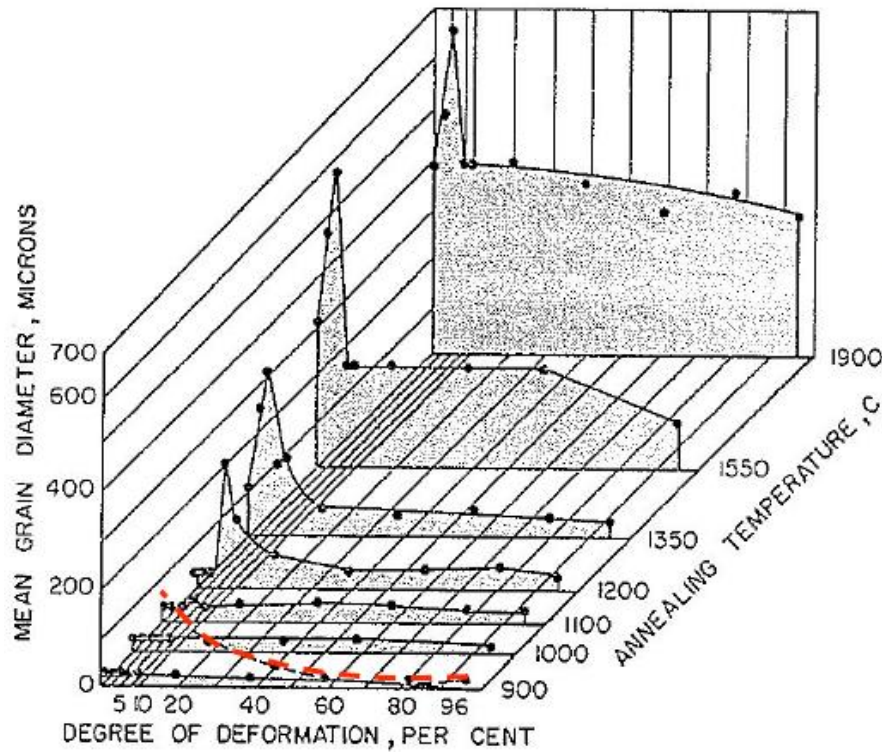

- deformation > 65% =>
 - uniform nucleation
 - small grains
- if purity ↑, T_{recryst} ↓
 - RRR ≤ 100 => $T_{\text{recryst}} \geq 900$ C
 - RRR 300 => $T_{\text{recryst}} \sim 800$ C*
 - RRR 400 => $T_{\text{recryst}} \sim 750$ C ?



Not completely recrystallized Nb



Completely recrystallized Nb

Recrystallization

We need recrystallized material

Recrystallization

The grain structure influences the formability

Therefore the yield strength, $\sigma_{0,2}$ is specified for XFEL as

$$50 < \sigma_{0,2} < 100 \text{ N/mm}^2 \text{ (Mpa)}$$

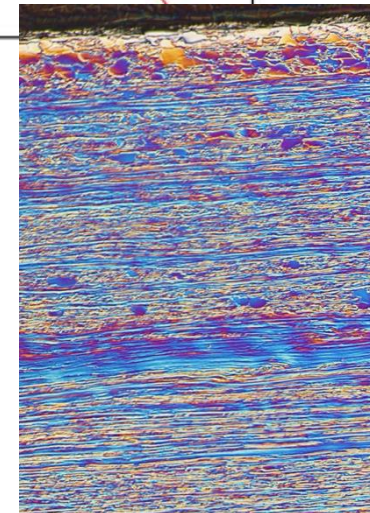
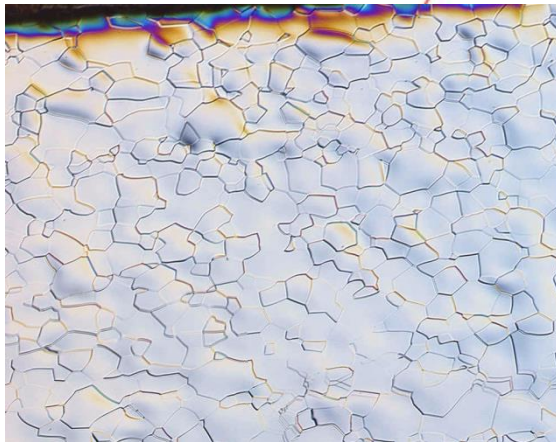
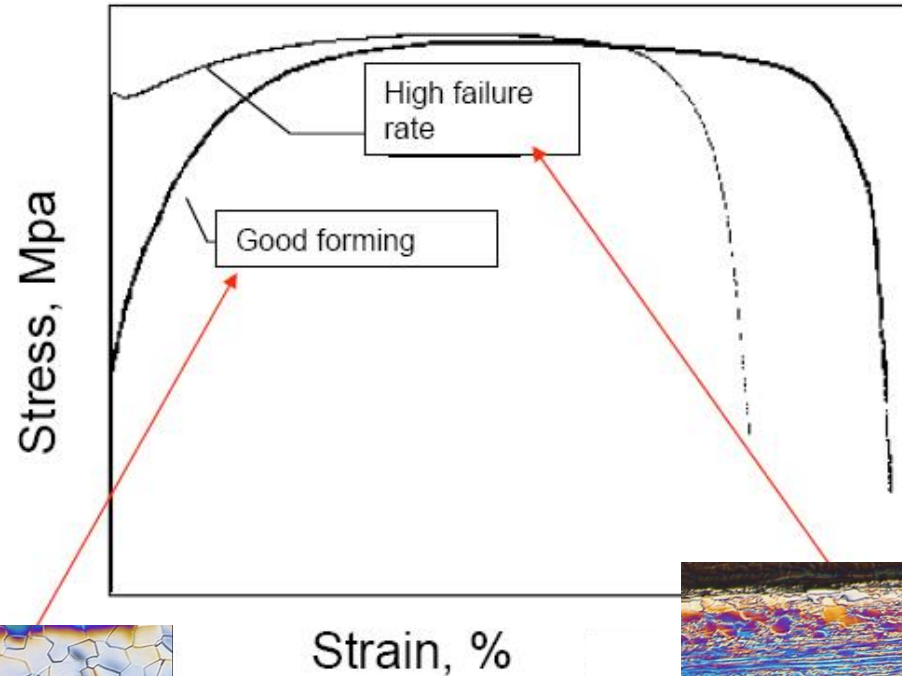

Nb Mechanical Properties at Low T

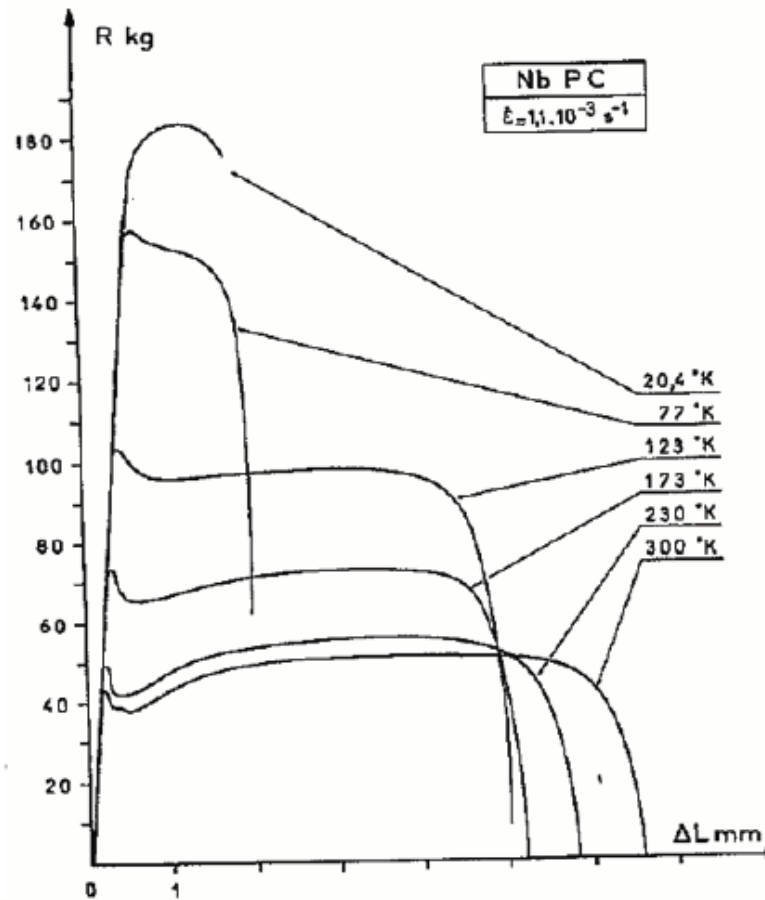

- Yield strength $\uparrow\uparrow$ when $T \downarrow$
- ductility \downarrow ($T < 20 \text{ K} \Rightarrow \text{Nb is brittle}$)

Nb Sheets: Technical Specifications

Concentration of impurities in wt.ppm				Mechanical properties	
Ta*	≤ 500	H*	≤ 2	Yield strength**, $\sigma_{0,2}$	$50 < \sigma_{0,2} < 100$ N/mm ² (Mpa)
W*	≤ 70	N*	≤ 10	Tensile strength**	> 100 N/mm ² (Mpa)
Ti*	≤ 50	O*	≤ 10	Elongation at break**	30 %
Fe*	≤ 30	C*	≤ 10	Vickers hardness** HV 10	≤ 60
Mo*	≤ 50	RRR*	≥ 300	Absence of foreign material inclusions*	Proven by scanning
Ni*	≤ 30	Recrystal. degree. Grain size* ,** ?	≈ 50 μm	Texture *, ** ?	

* - relevant for performance

** - relevant for successful fabrication

Nb Sheets Quality Control

RRR
measurement



東京電解 (株)

東京電解 (株)



Tensile test

Tokyo Denkay
(Japan)

Gas
analysis

酸素・窒素分析装置

東京電解 (株)



Gas analysis (Hydrogen, Oxygen, Nitrogen) : HORIBA

Nb Purity: RRR

Electrical resistivity of metals at low temperatures is related to the impurity concentrations. The residual resistivity at $T=0\text{K}$ is caused mainly by scattering of electrons by impurities.

Residual Resistivity Ratio:

$$RRR = \frac{\rho(295\text{K})}{\rho(4.2\text{K})}$$

$$\rho(T) = \rho_{res} + \rho_{ideal}(T)$$

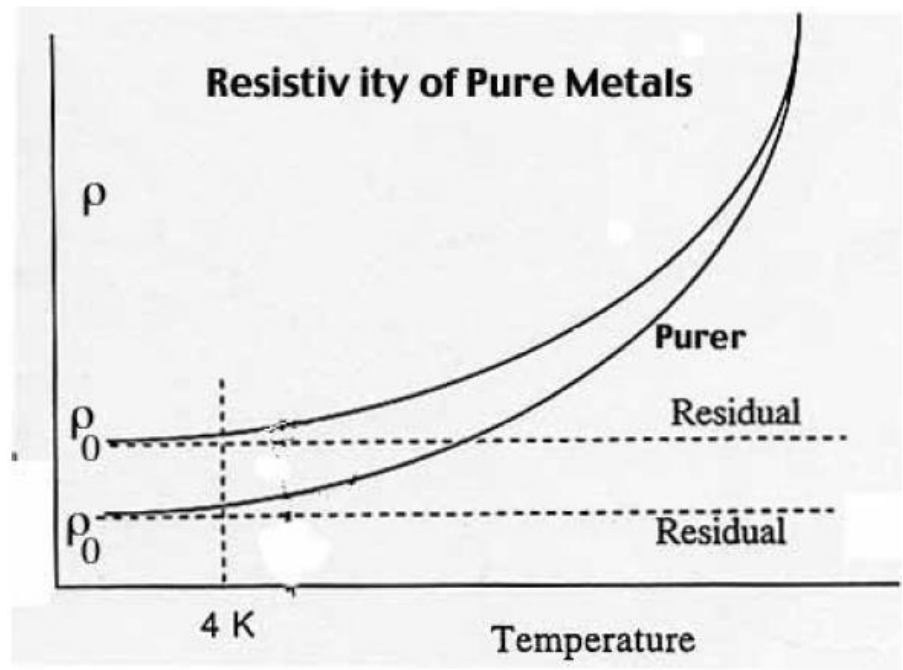

RRR Measurement

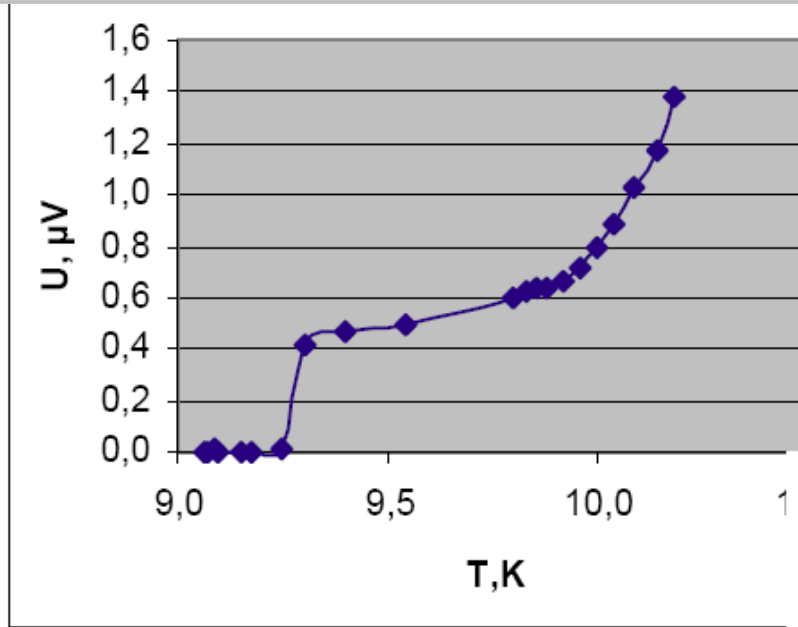

Temperature dependence of resistivity for superconducting Nb at temperatures close to T_c

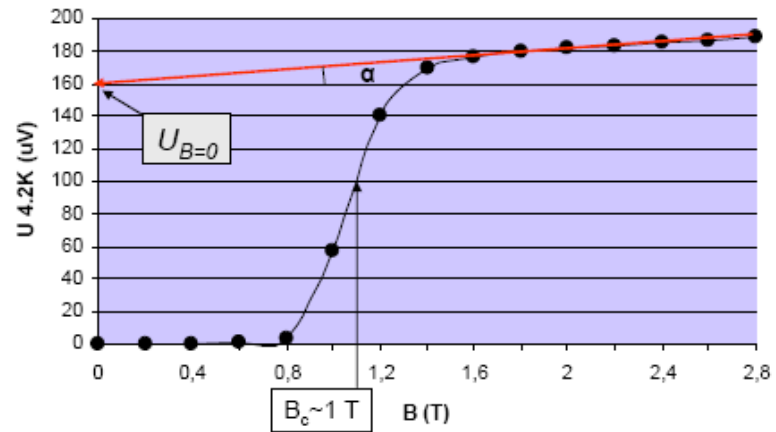
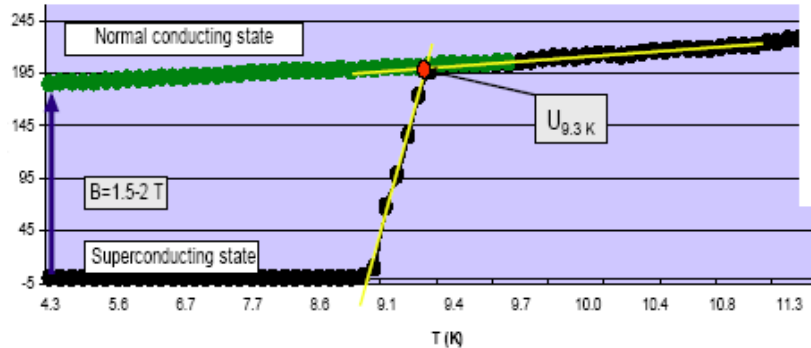

RRR determination by magnetic field extrapolation method

DC method: extrapolation of $U(T)$ curve

Influence of Impurities on RRR

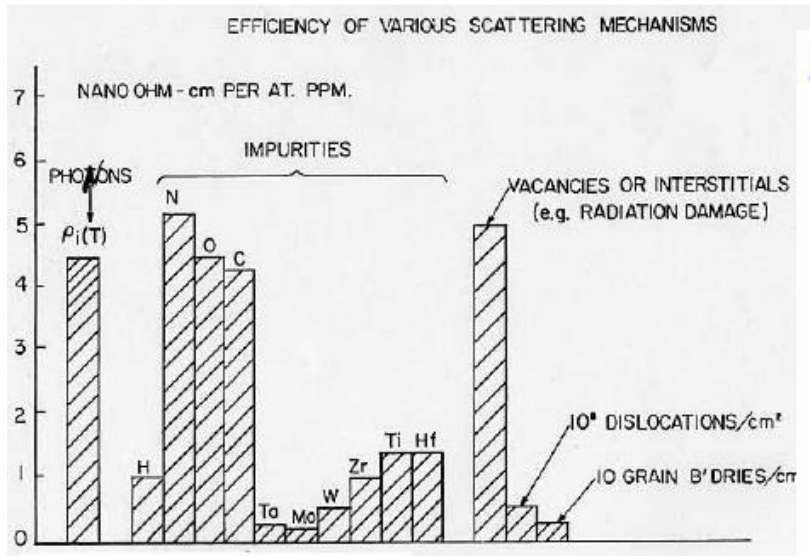

Contribution of different defects in the scattering mechanism:

$$RRR = \frac{\rho(300K)}{\rho_{ideal}(4.2K) + \sum_i \frac{\partial \rho_i}{\partial C_i} C_i}$$

$$\rho(300K) = 14.6 \mu\Omega \text{ cm}$$

$$RRR_{ideal} \cong 35,000$$

Industrial Niobium Production – Intestinal impurities and RRR(Tokyo Denkai Co. Ltd.)

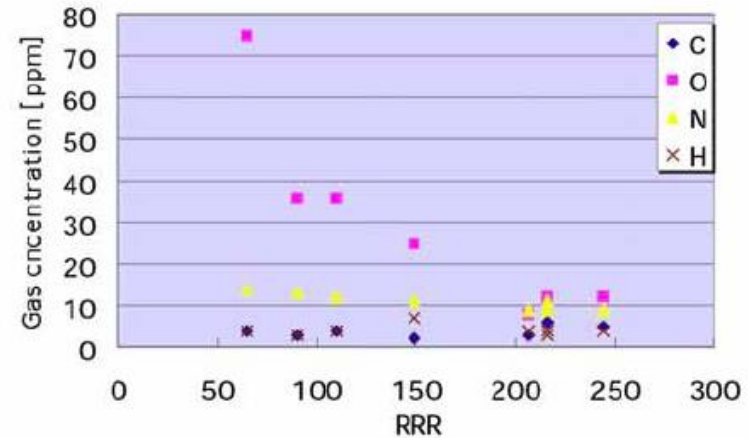

Relationship between RRR and nonmetallic impurities measured by Tokyo Denkai

Expected RRR contribution for Nb for 1 wt ppm of impurities

Element	RRR	Element	RRR
H	2640	Zr	102 000–239 000
N	4230	Hf	200 000
C	4380	W	262 000–721 000
O	5580	Mo	717 000
Ti	53 700	Ta	1 140 000

Nb Thermal Conductivity

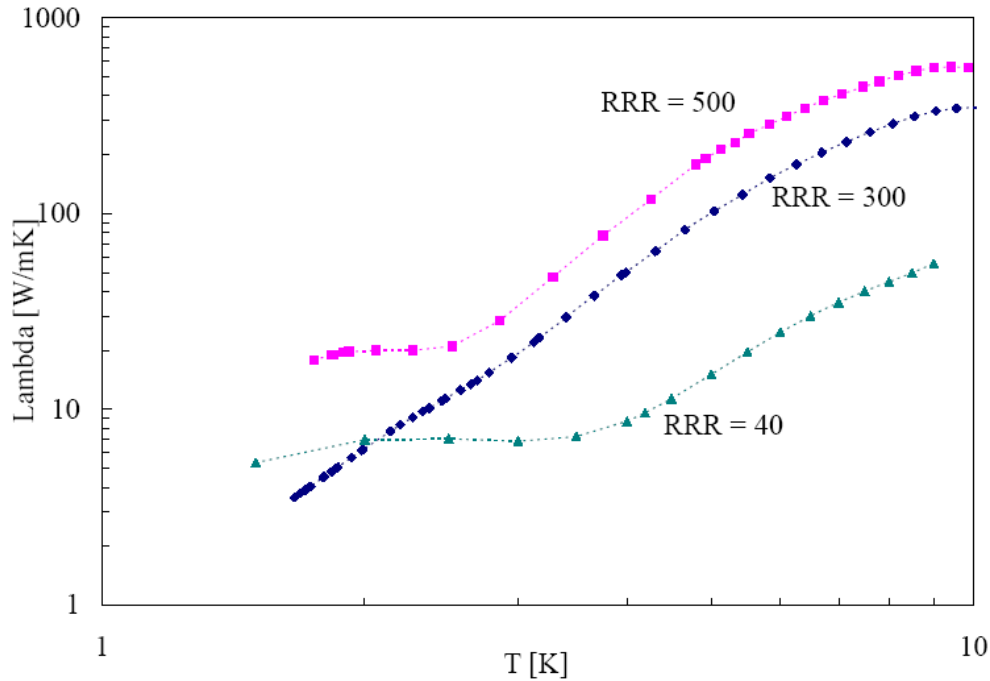

Rule of thumb:

$$\lambda(4.2\text{K}) = C \cdot \text{RRR}$$

$$C \sim 0.25 \text{ W}/(\text{m K})$$

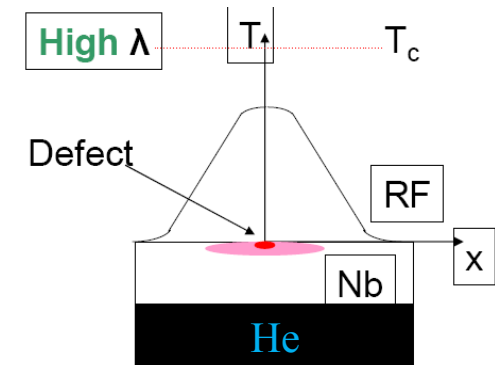
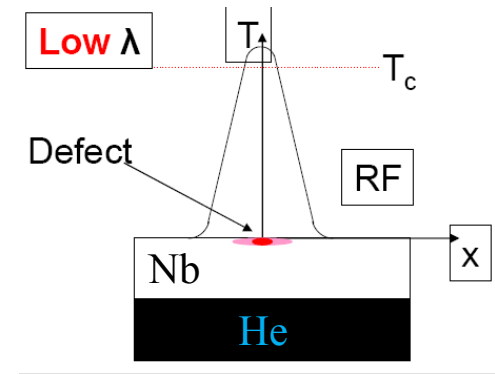

Nb Thermal Conductivity

- ✱ Heraeus Large Grain RRR477
- ✱ Heraeus Single Crystal RRR438
- ✱ Heraeus Single Crystal RRR 479
- ✱ Heraeus Single Crystal RRR465
- ◆ Fine Grain RRR1200
- ◆ Wah Chang Fine Grain RRR500

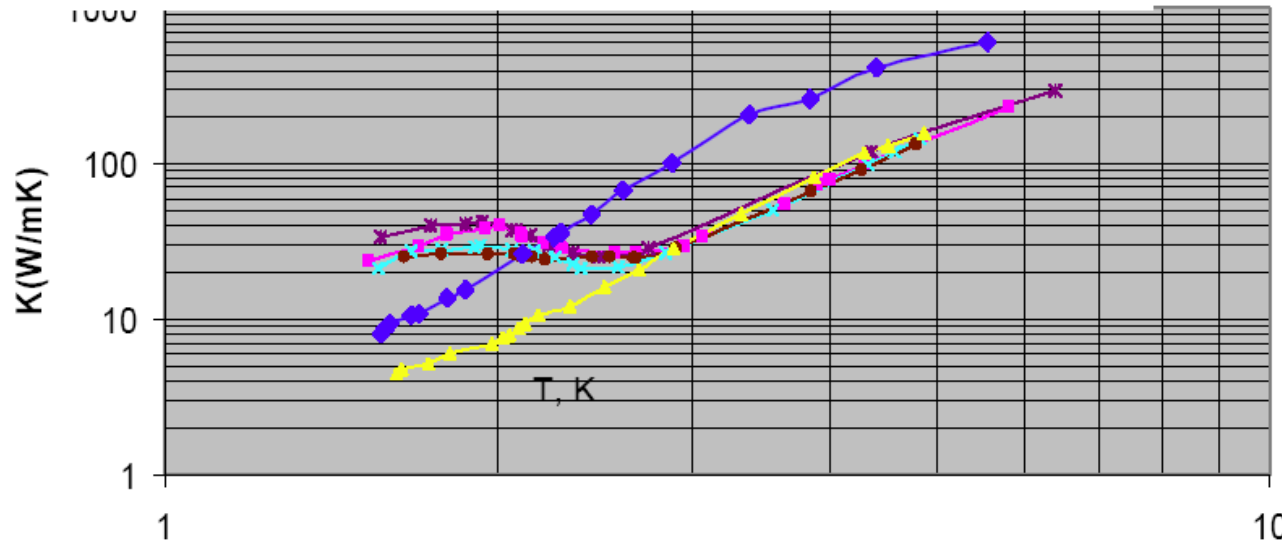

Phonon peak is clearly observed for single crystals/large grain samples.

$$\lambda(T, RRR, G) = R(y) \cdot \left[\frac{\rho_{295K}}{L \cdot RRR \cdot T} + a \cdot T^2 \right]^{-1} + \left[\frac{1}{D \cdot \exp(y) \cdot T^2} + \frac{1}{B \cdot G \cdot T^3} \right]^{-1}$$

Electron term

Lattice term

$$y = \Delta/k_B T$$

$$R(y) = \lambda_{es}/\lambda_{en}$$

$$L \cong 2.45 \times 10^{-8} \text{ W/K}^2$$

G : phonon mean free path \sim grain size

Texture

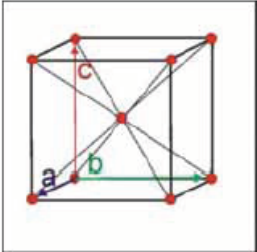

bcc lattice (body centered cubic)

3 mm Nb sheet

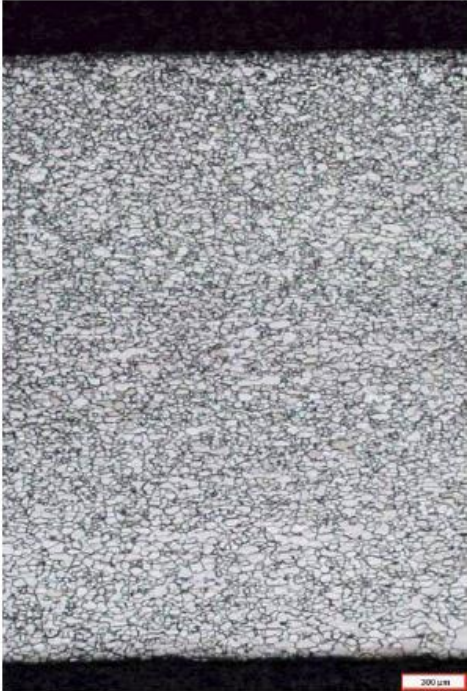

ND

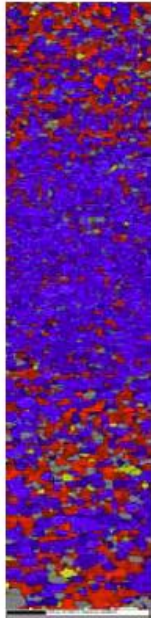

Z

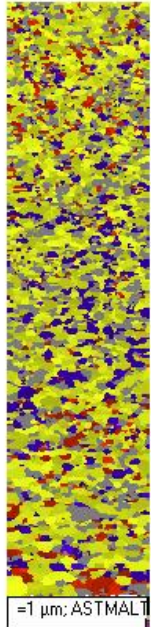

H.C. Starck
Improving High Tech Materials

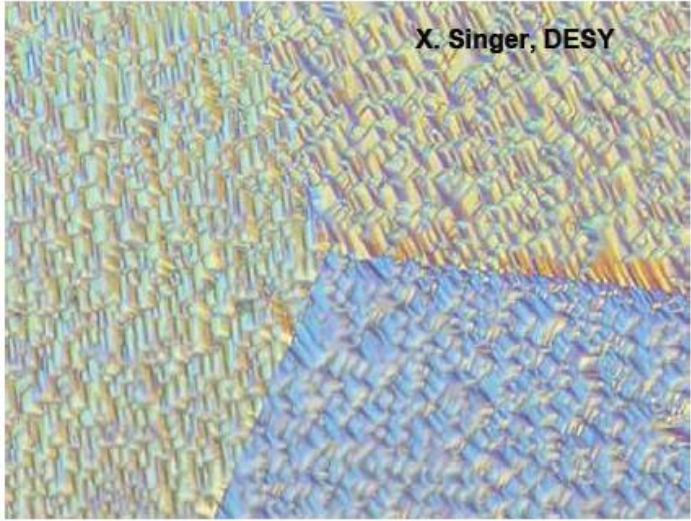

Microstructure of the three grains of Nb after proper etching (optical microscope). The crystal lattice in neighboring grains is the same (bcc) but has a different orientation

Electron back scattering diffraction EBSD

Niobium sheet after annealing. Colors refers to crystal orientations (orientation image)

Price

- High RRR Nb (RRR \sim 300): \sim \$ 530/kg
- Reactor grade Nb (RRR \sim 30): \sim \$ 130/kg

Quality Control of Nb Sheets



DESY eddy current scanning apparatus for niobium discs.
100% Nb sheets for TTF scanned and sorted out.
Feedback to manufacturer was very important

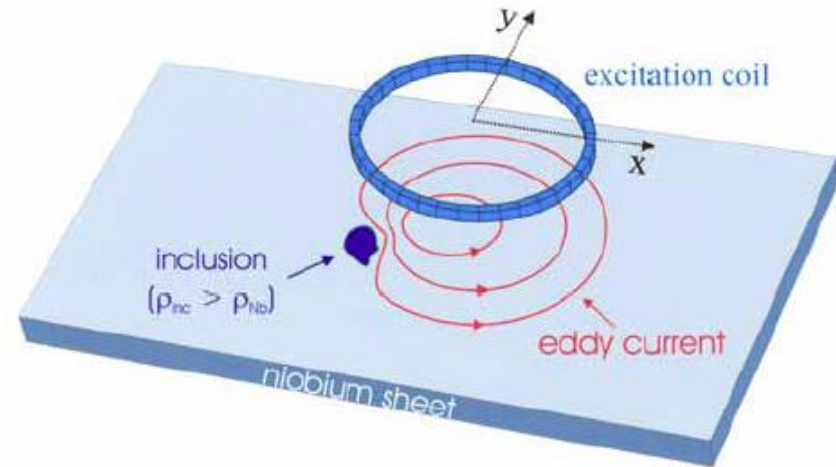

Principle of eddy current measurement

Defects in Nb Sheets

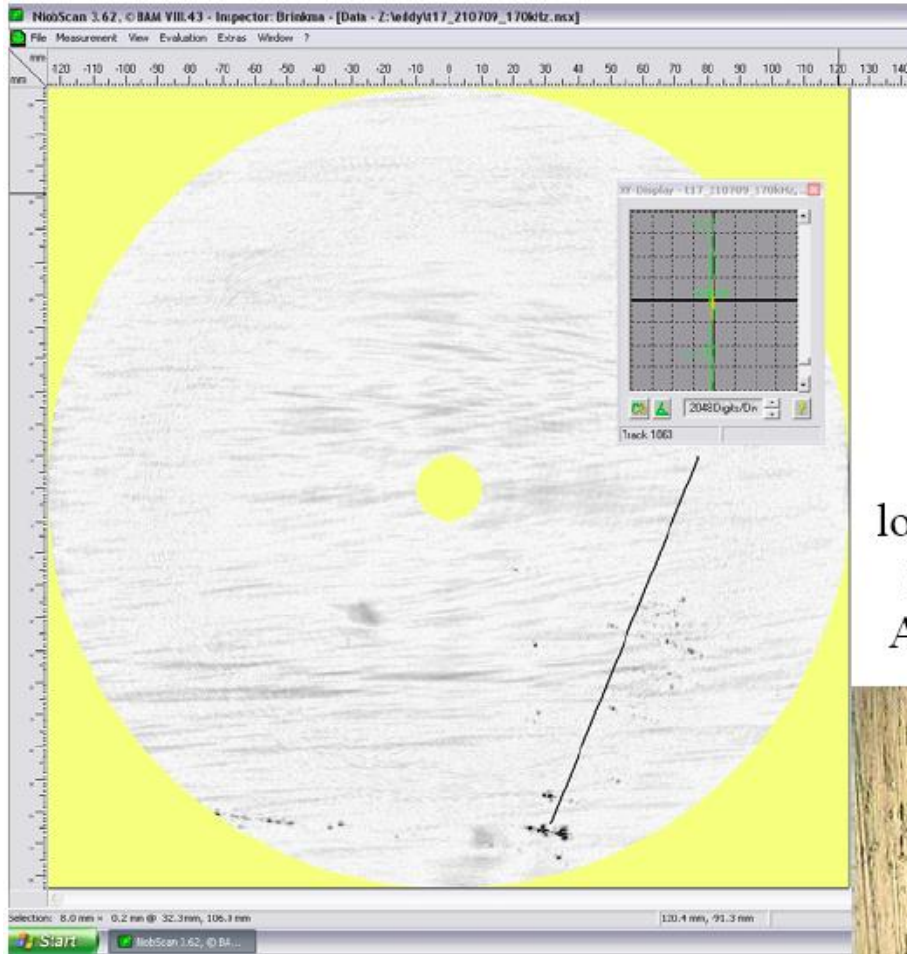

Iron particles, probably imbedded during rolling T17

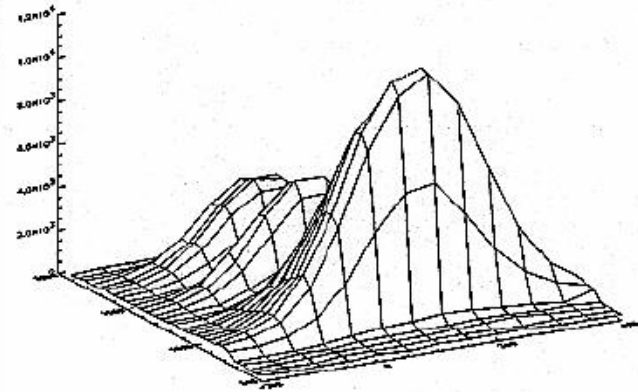

Iron signal distribution in one of the locations of the Nb sheet T17 measured Synchrotron Radiation Fluorescence Analysis (SURFA) and defects image.

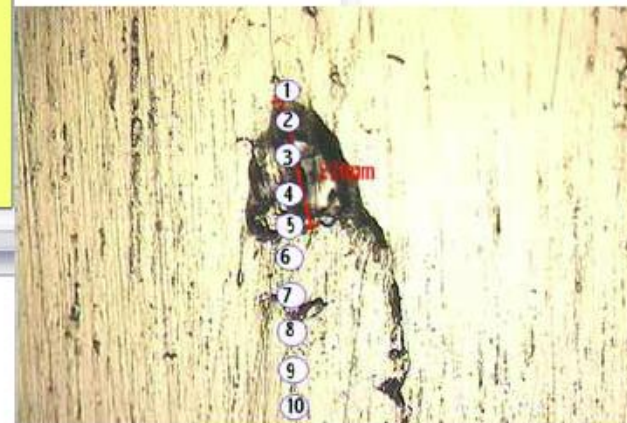

Feedback Example: Final Rolling



Example of the feedback to companies: Tokyo Denkai improved the cleanness around of the rolling equipment

Overview of Cavity Components (ILC)

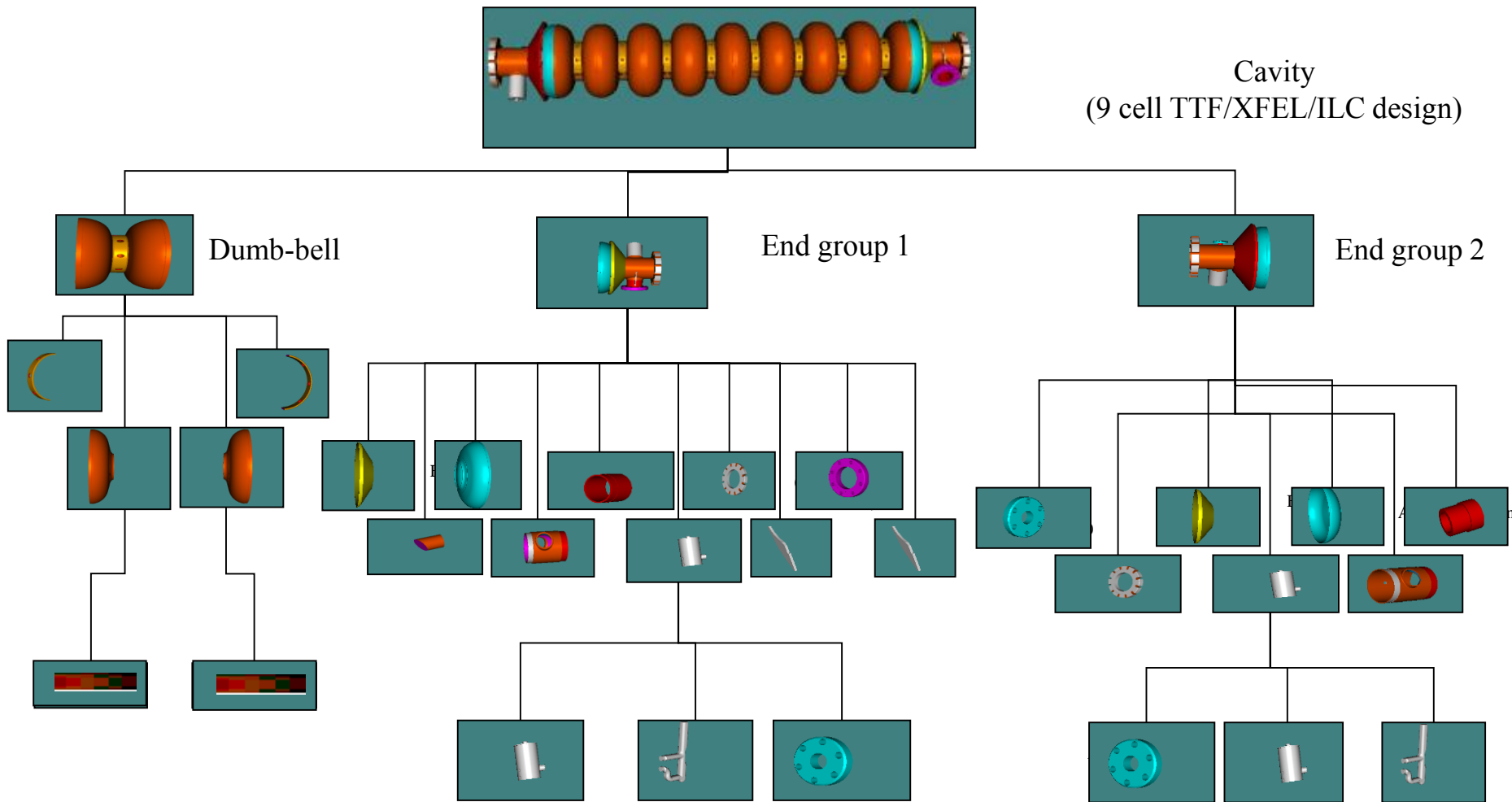

Dumb-bell Fabrication

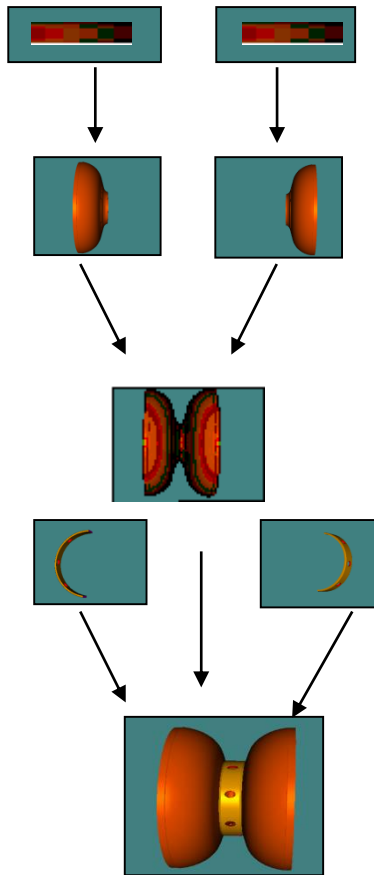

Dumb- bell

1. Deep drawing
2. Mechanical measurement
3. Cleaning (by ultra sonic cleaning + rinsing)
4. Trimming of iris region and reshaping of cups if needed
5. Cleaning
6. RF measurement of cups
7. Buffered chemical polishing + Rinsing (for welding of Iris)
8. Welding of Iris
9. Welding of stiffening rings
10. Mechanical measurement of dumb-bells
11. Reshaping of dumb-bell if needed
12. Cleaning
13. RF measurement of dumb-bell
14. Trimming of dumb-bells (Equator regions)
15. Cleaning
16. Intermediate chemical etching (BCP, 20- 40 μm) + Rinsing
17. Visual Inspection of the inner surface of the dumb-bell, local grinding if needed + (second chemical treatment + inspection)

Dumb-bell ready for cavity

Deep Drawing

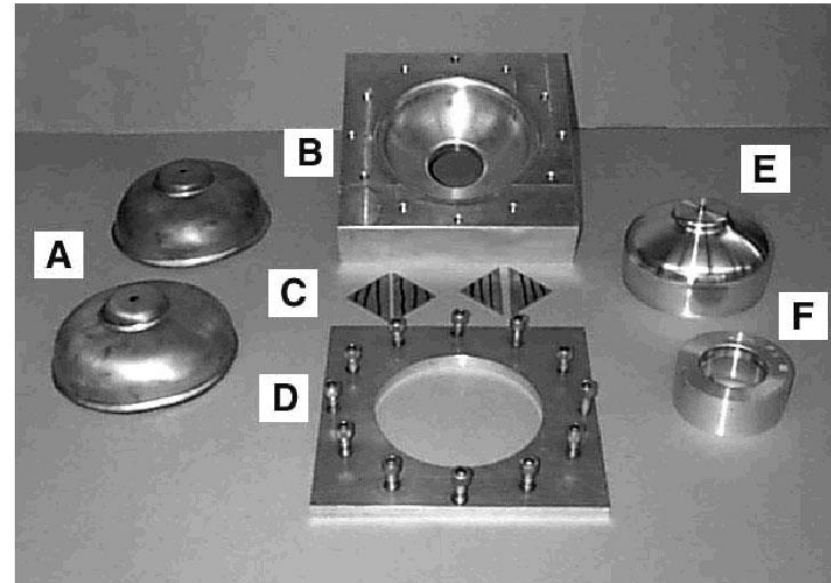
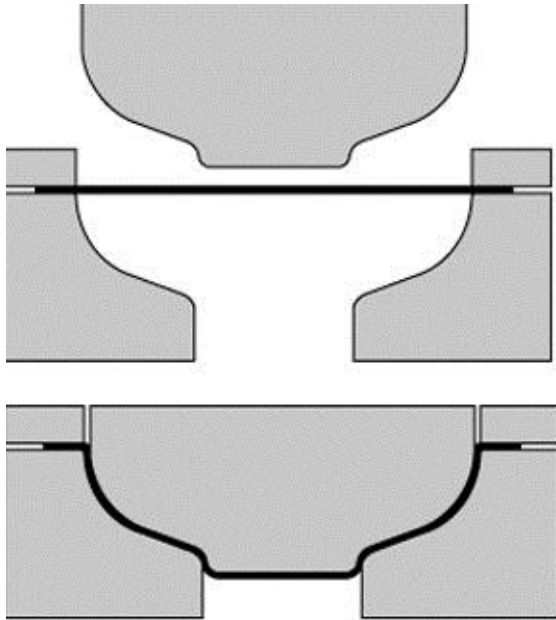

- Deep drawing with hydraulic press
 - 100 tons + 25 tons for iris coining for 10.25” discs (ILC)
 - 400 tons + 50 tons for iris coining for 15.5-16.5” discs (SNS)

Deep Drawing

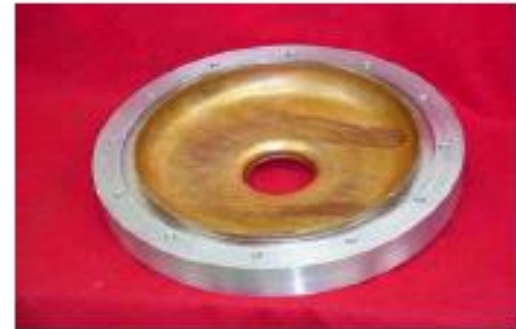

Shape Measurement

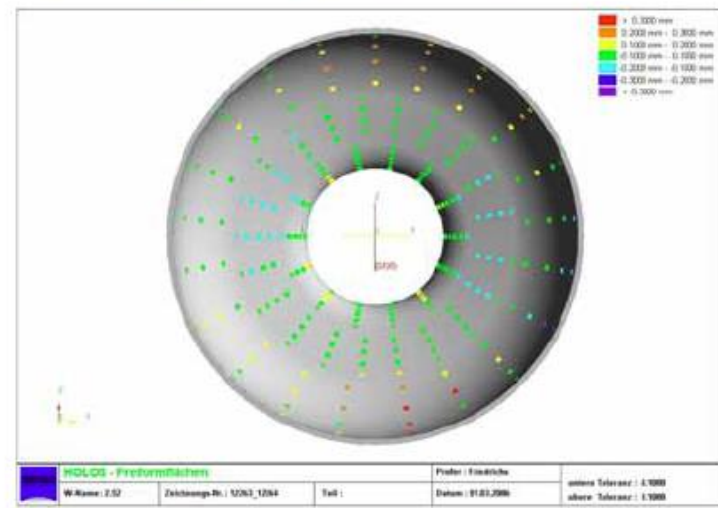
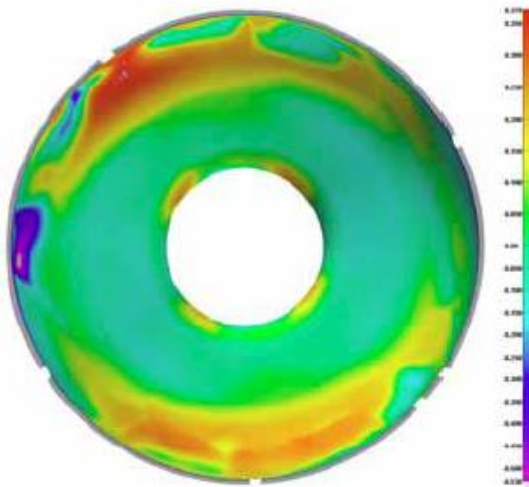

Shape accuracy: optical and mechanical 3D measurement of the half cell shape

Mechanical Grinding



- Mechanical grinding of visible local defects with aluminum oxide grinding discs

RF Measurements of Dumb-bells and Middle-Cups

Elongation ΔL_e in the magnetic field region

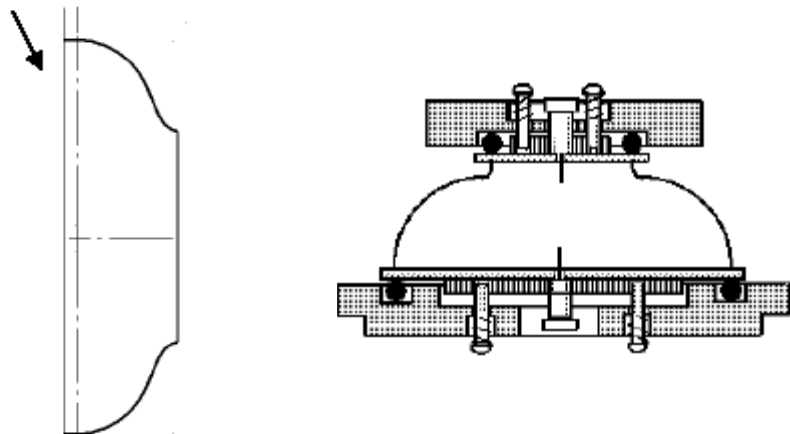
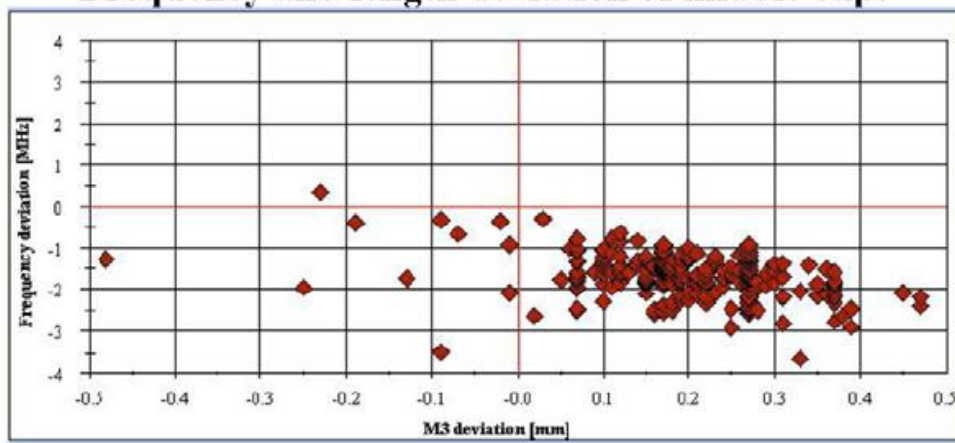

Figure 3: Trimming of the equator to adjust the elongation at the equator



Frequency and length deviation of middle cups



Wah Chang (EDMS-DB)

Measure frequency and length to determine how much to trim at the equator to obtain target frequency and length of the cavity fully welded

Cavity Parts



- Welding sequence:
 - Two cups form a dumb bell
 - Stiffening ring at iris
 - Welding together two dumb-bells
 - Add next dumb bell
 - Add end group
 - For mass production: weld all dumb bells at once



Cavity Welding Preparation Steps

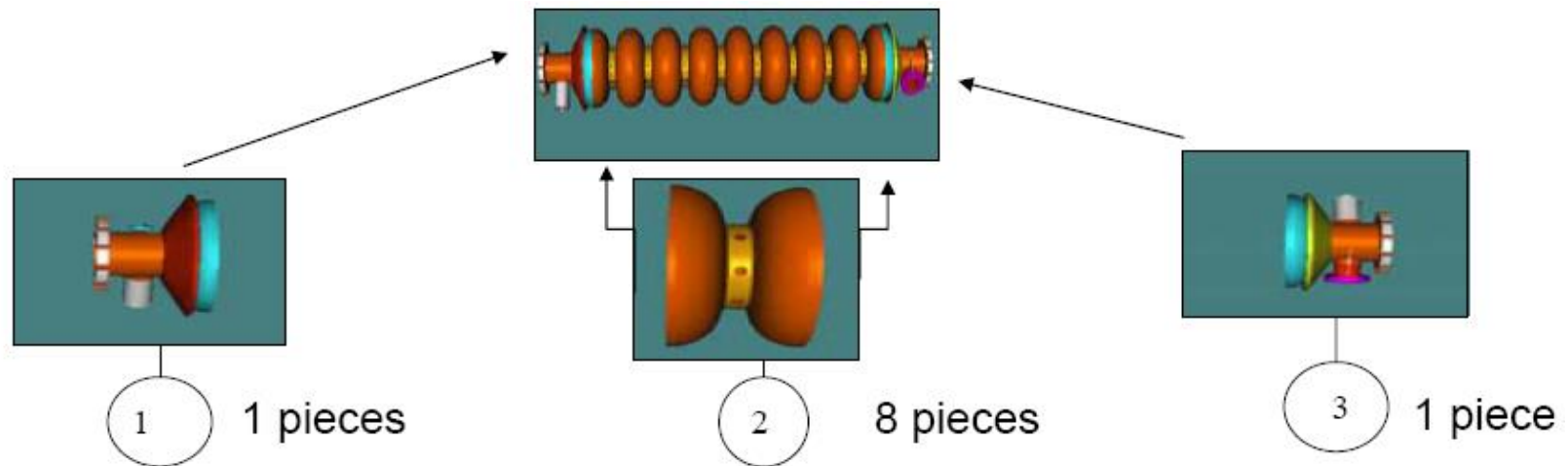

1. Degreasing and rinsing of parts
2. Drying under clean condition
3. Chemical etching at the welding area (Equator)
4. Careful and intensive rinsing with ultra pure water
5. Dry under clean conditions
6. Install parts to fixture under clean conditions
7. Install parts into electron beam (eb) welding chamber
(no contamination on the weld area allowed)
8. Pump down to vacuum in the EBW chamber E^{-5} mbar
9. Welding and cool down of Nb to $T < 150^{\circ} C$, venting
10. Leak check of weld

Electron Beam Welding

- Welding under good vacuum, 10^{-5} mbar range
- Broad welding seam
 - Operate with defocussed beam
 - Smooth underbead
- Overlap at end of welding to avoid accumulation of impurities
- Wait to cool down before opening chamber

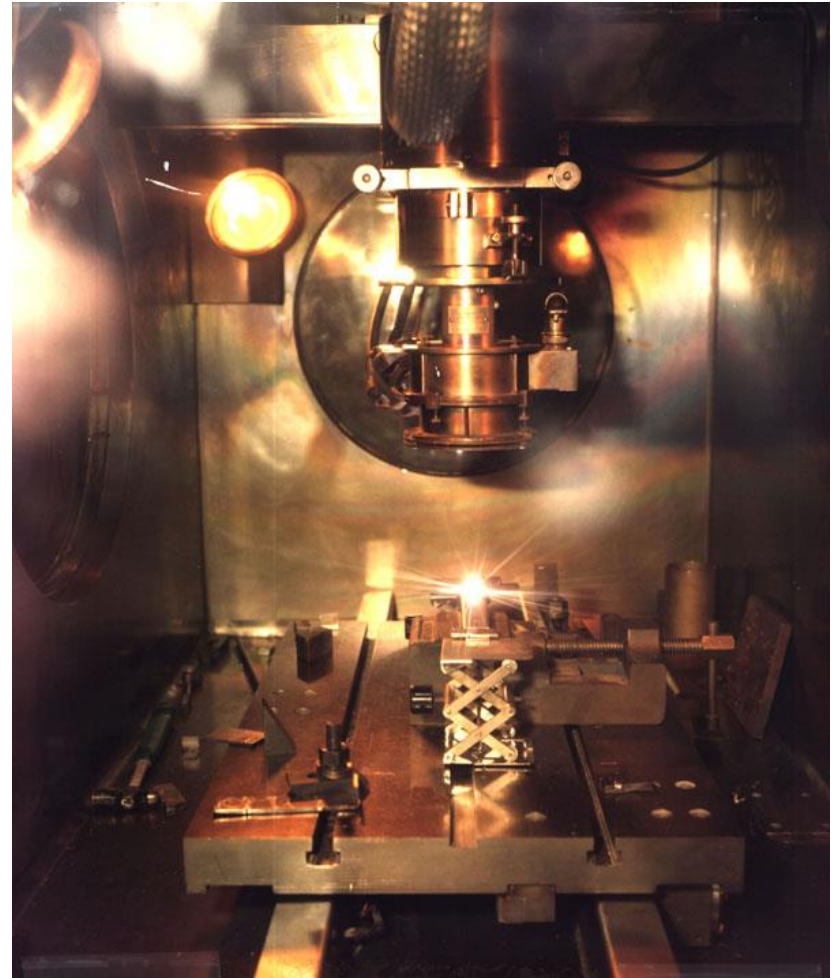

Electron Beam Welding

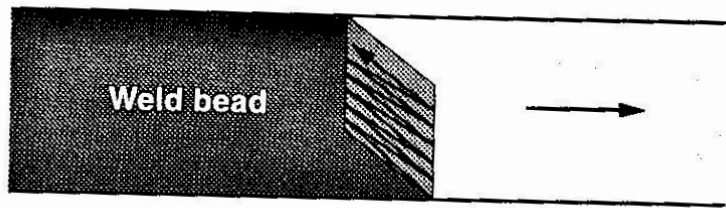
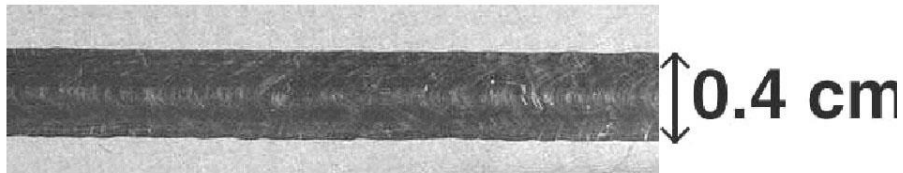

Rhombic raster pattern for the beam during EBW. This rastering produces a well-defined and reproducibly defocused beam

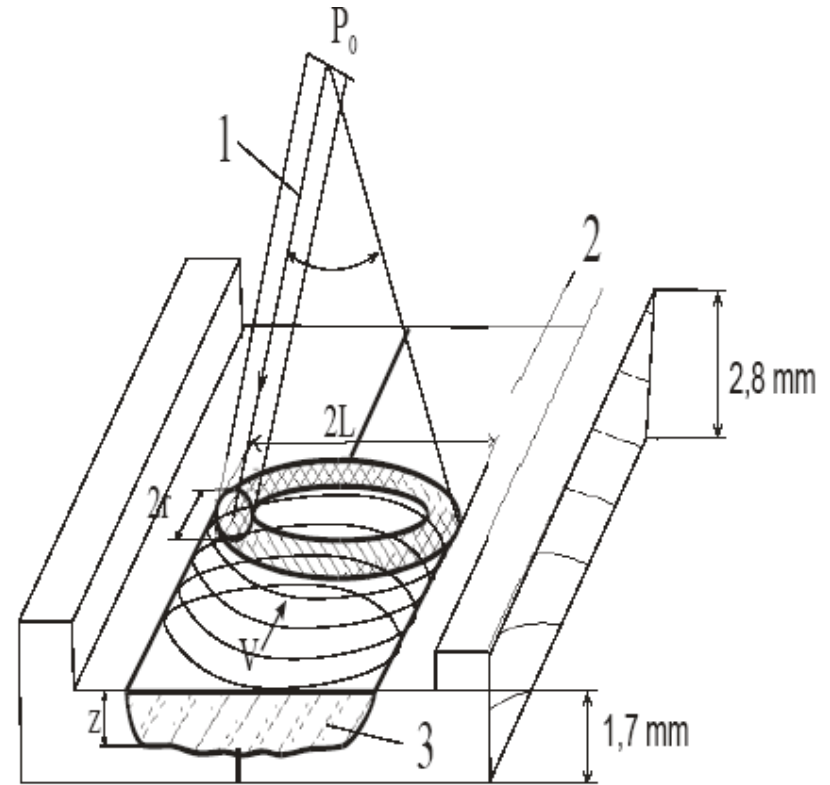

Welding Scheme (circular raster)

1-Electron beam (P_0 -power of the beam, r -spot radius on the surface, L -scanning amplitude, V -velocity of the beam movement)

2-Nb sheet

3-melting zone (z -depth of the melting zone).

Microstructure of Nb EBW Joint

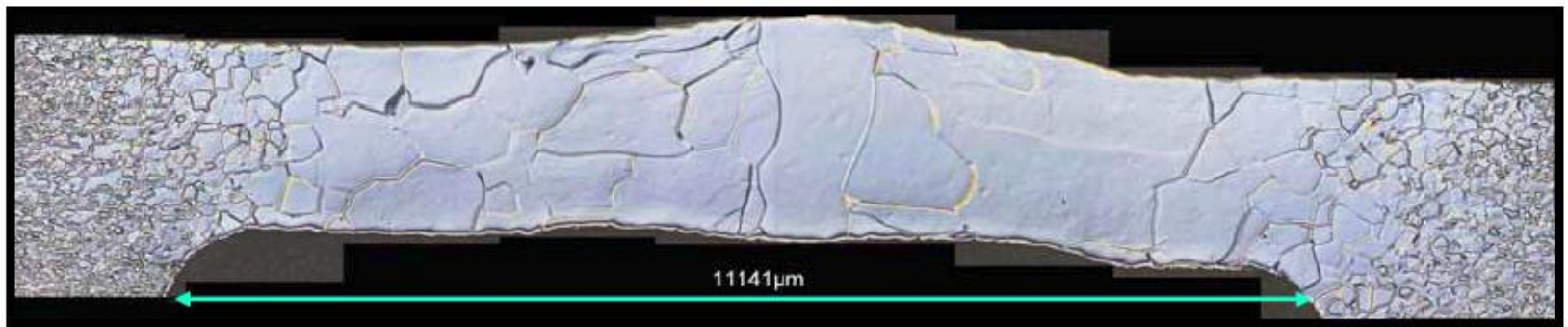

Microstructure of the EB welding area. The grain size is $50 \div 2000 \mu\text{m}$

EBW Machine (JLab)

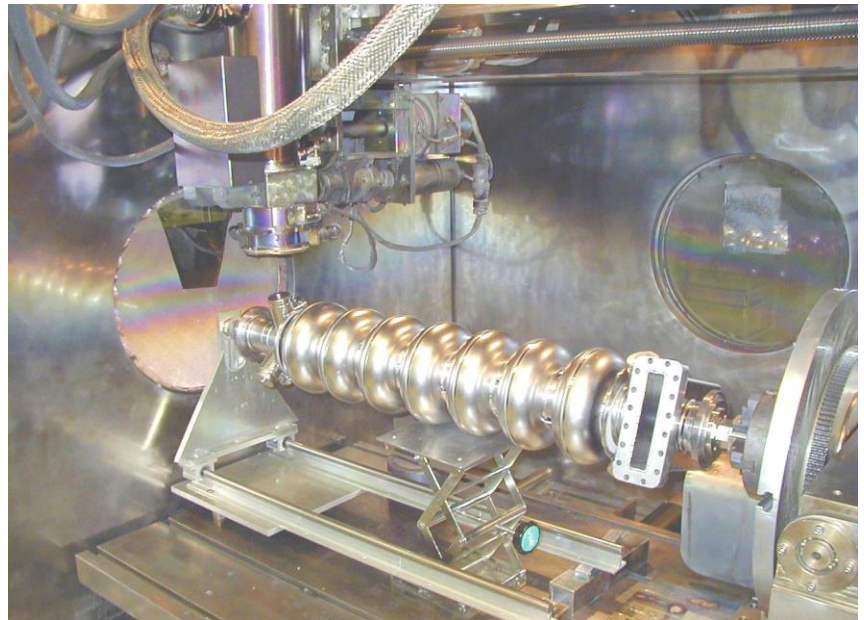

Tack- Welding: 4 tacks, focused beam
Voltage : 50 kV
Current: 15 mA
Rotational Speed : 20 inches/min
Distance of gun to work : 6 “
Final weld Current: 33 mA
Rotational speed: 18”/min
Focussing: elliptical pattern

EBW Machine (DESY)

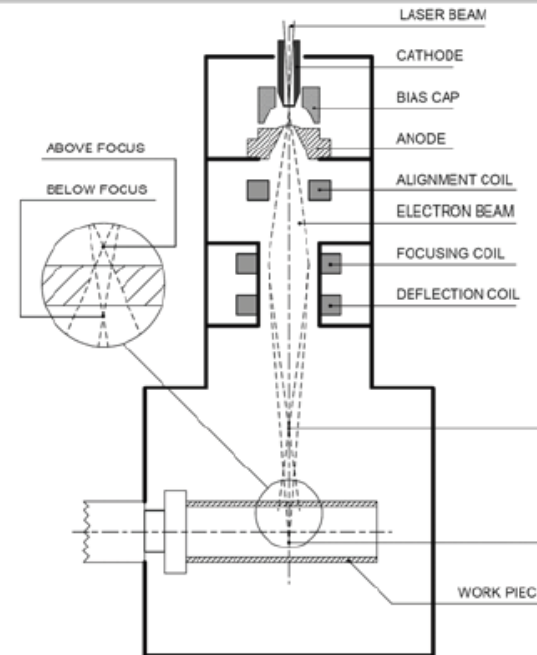

Specification of DESY

Electron Beam Welding Machine

Voltage: 70 - 150 kV

Beam power: max. 15 kW

Beam current: 0 bis 100 mA

Chamber size: 3300mm x 1400mm x 1600mm (ca. 7,4 m³)

Vacuum: > 5x10⁻⁶ mbar (ca. 2x10⁻⁸ mbar)

Pumping time: ca. 20 min = 3x10⁻⁶ mbar

2 Cryogenic - Pumps: ca. 2 × 10.000 l/s

Displacement along the X-Axes ca. 1400 mm

Nb RRR After EBW

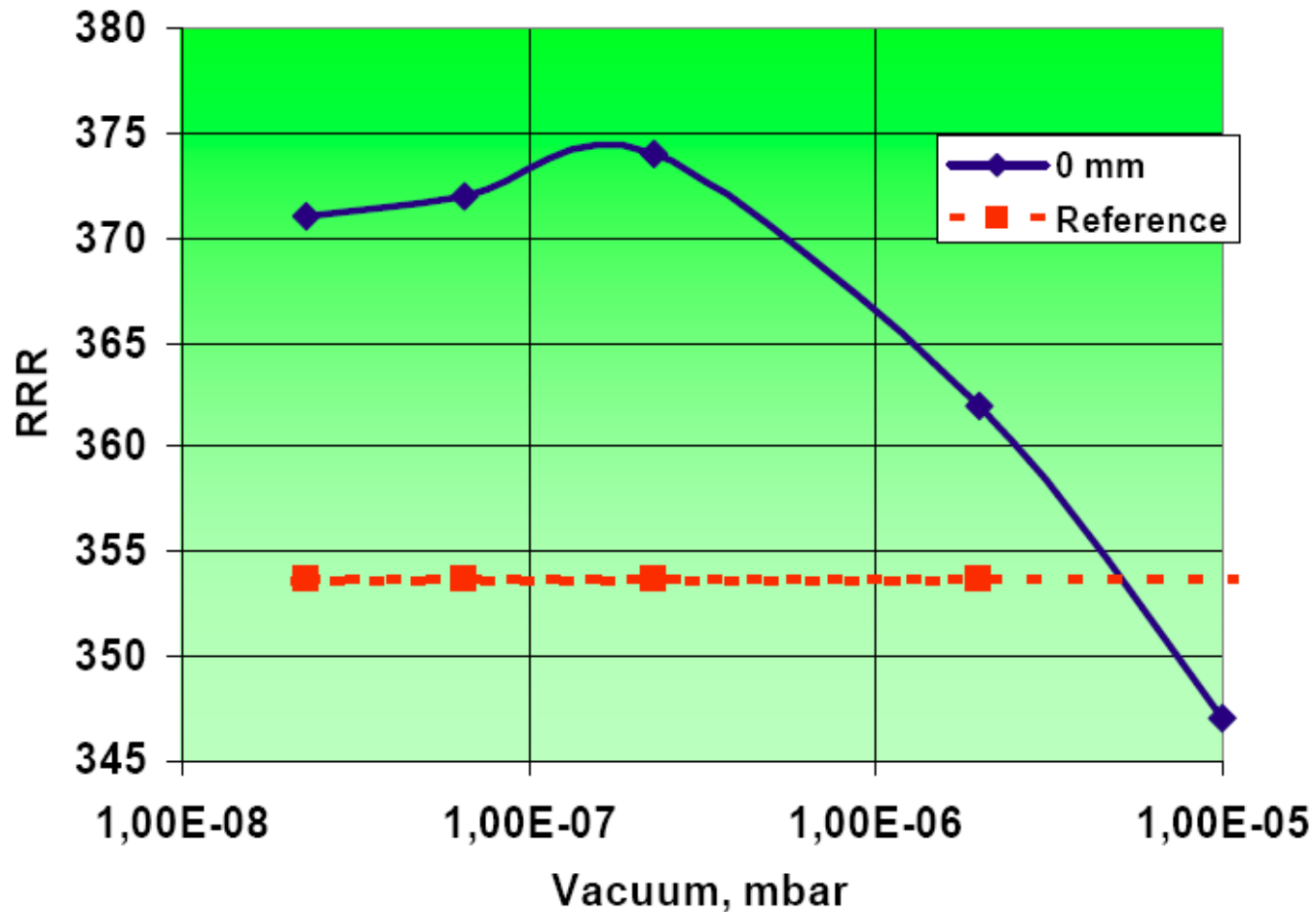

RRR in the welding seam versus pressure in the welding chamber

The RRR degradation at welding seam started since pressure of ca. 10^{-5} mbar.

RRR Variation After EBW

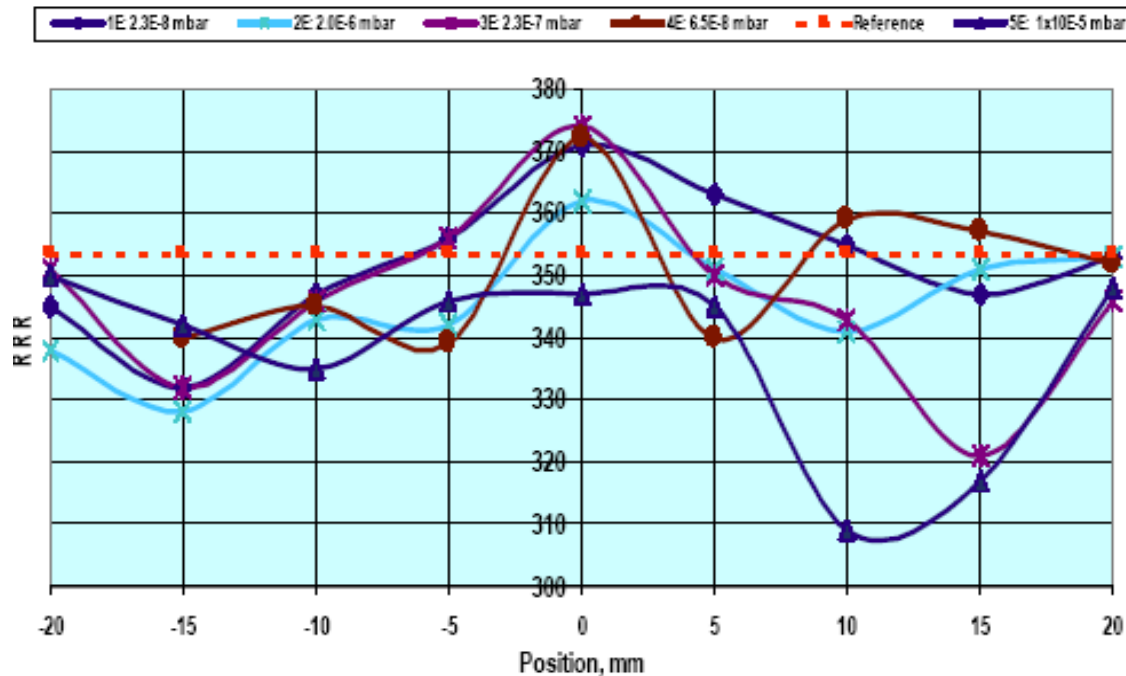

RRR in the EB welding area versus distance from the welding seam at different pressures of DESY EBW facility

The RRR degradation can take place in the welding seam itself, but also in the thermally affected area and overlapping region

RRR Variation After EBW

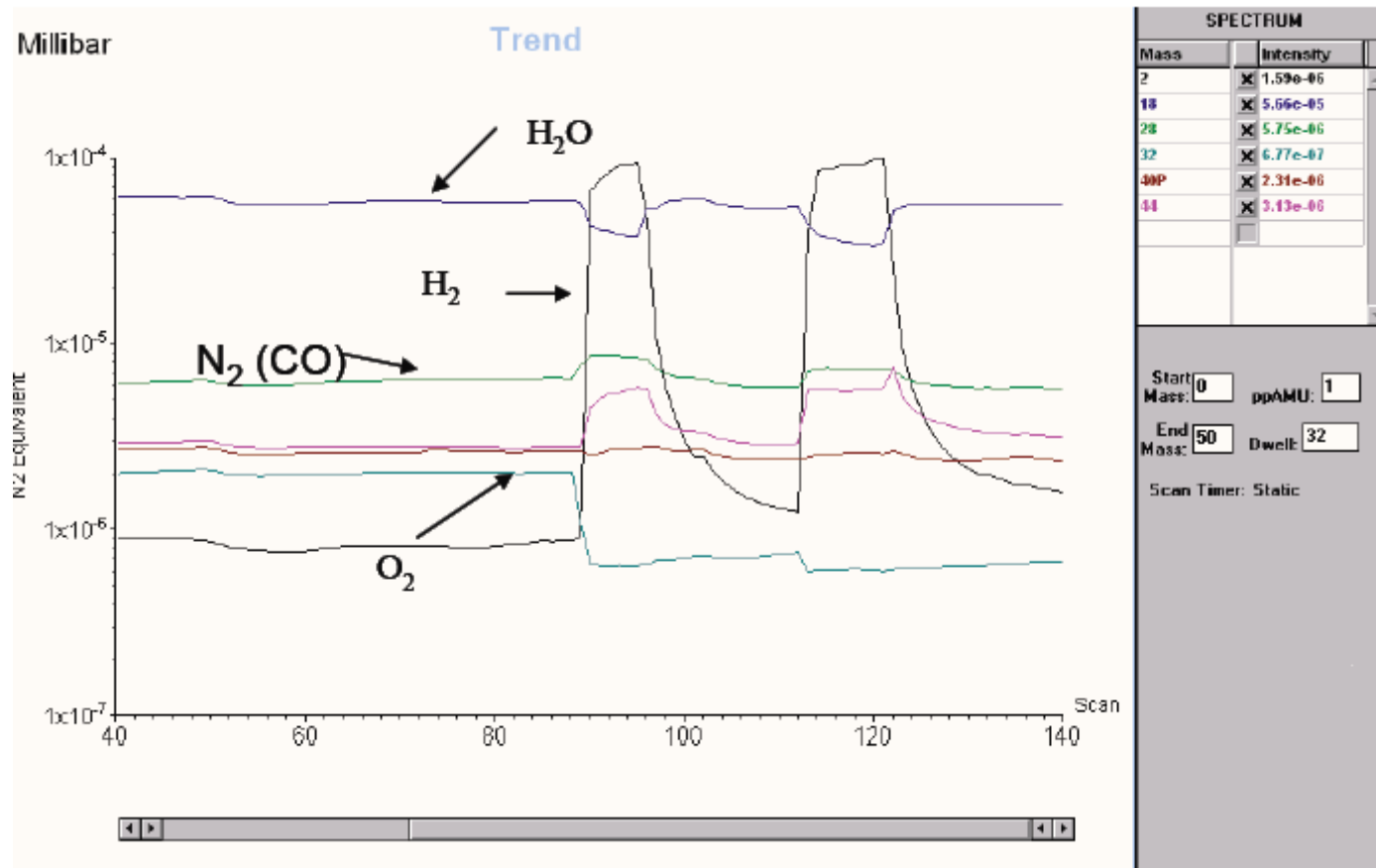

- Water decomposition during welding
- Hydrogen from water and due to degassing
- Oxygen uptake

Partial pressure in the EB chamber during welding of Nb300 sample

RRR Variation After EBW

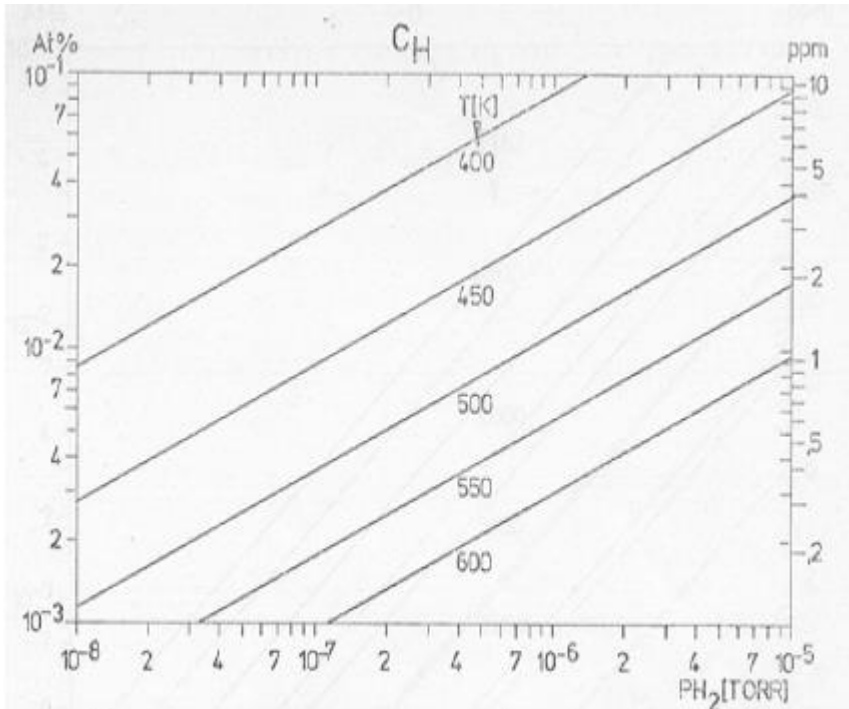

Pressure – concentration isotherms of hydrogen in Nb in steady state condition

Absorption of hydrogen can take place at the area with moderate temperatures

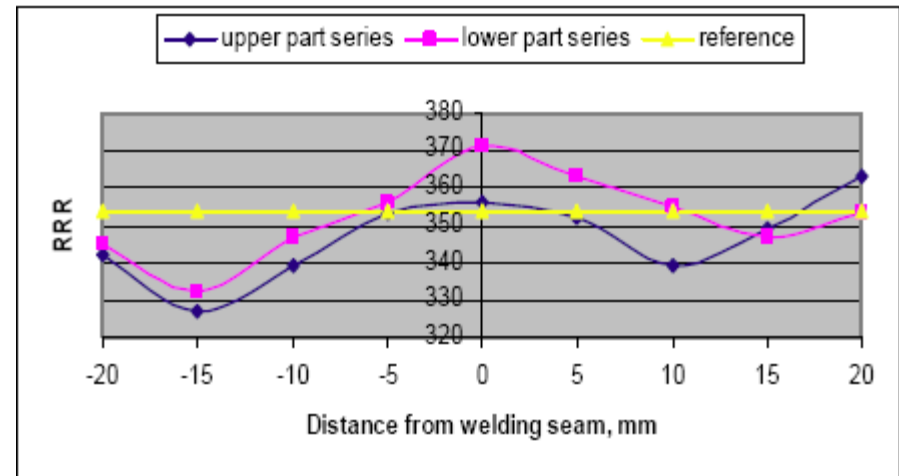
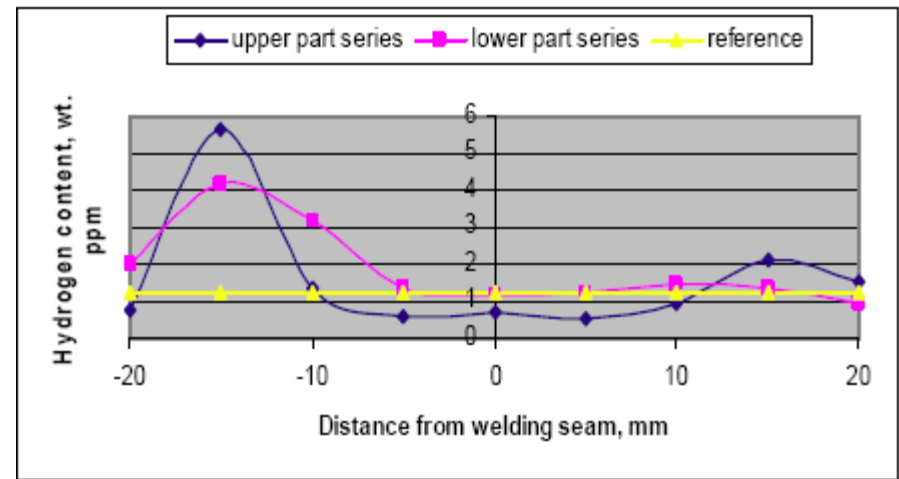

Comparison of RRR and hydrogen content in welding area (pressure 2.3×10^{-8} mbar)

Nb Contamination After EBW

Where the carbon come from?

- Diffusion pump
- Dirty EB chamber
- Not sufficient cleaning prior to weld...

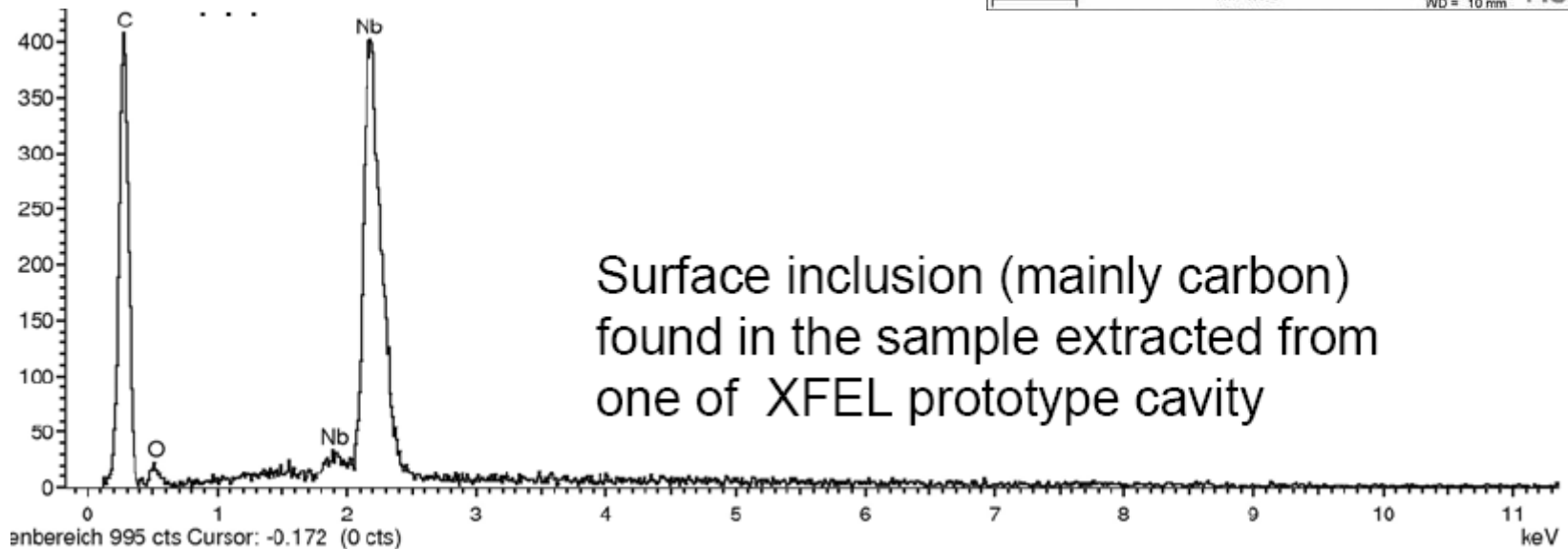
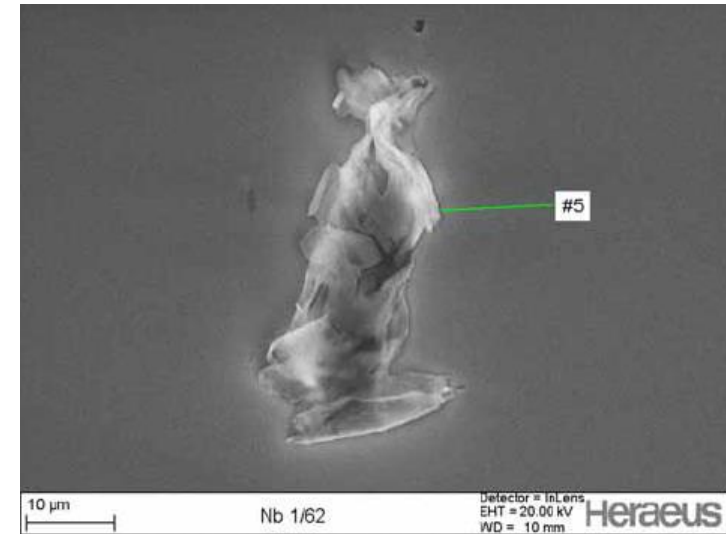

Surface inclusion (mainly carbon)
found in the sample extracted from
one of XFEL prototype cavity

Nb Contamination After EBW

Example Fe (iron)

Where the Iron come from?

- Nb sheet fabrication
- Deep drawing
- Handling

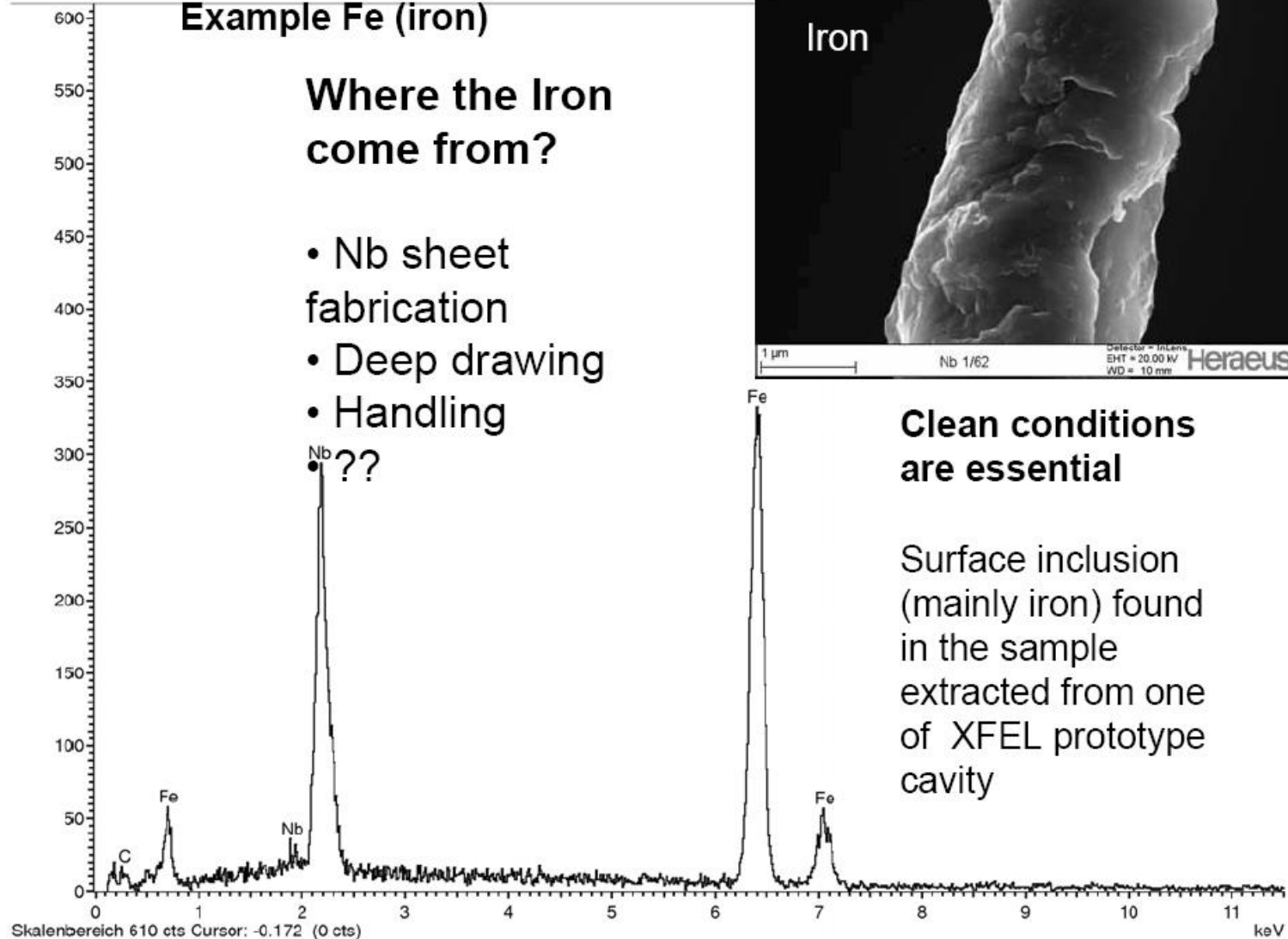
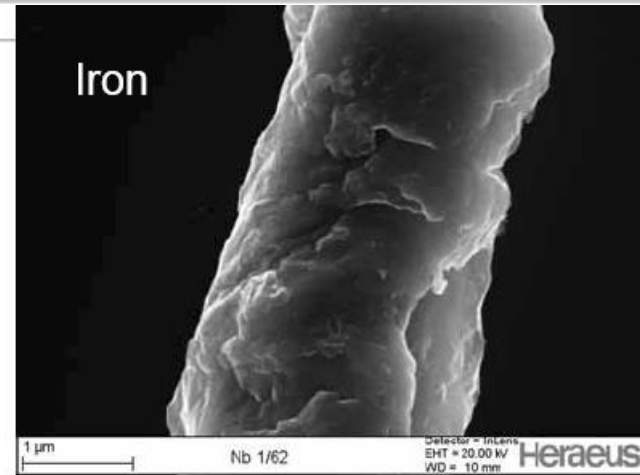

Clean conditions are essential

Surface inclusion (mainly iron) found in the sample extracted from one of XFEL prototype cavity

Welded Cavity Parts



Welded Cavity Parts



Cavity Inspection

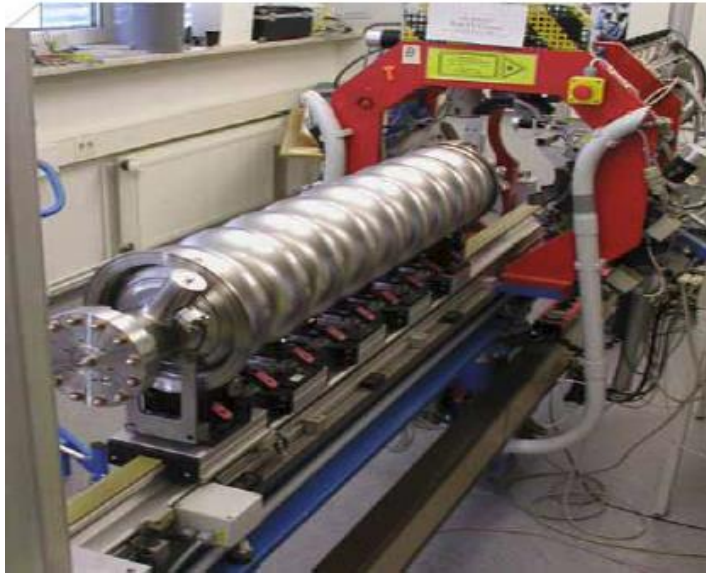

Eccentricity measurement

- Check of all mechanical tolerances
 - Take care with sealing surfaces
- Inspection of inner cavity surface
- Measure and adjust frequency and electrical field profile

Dimensional check

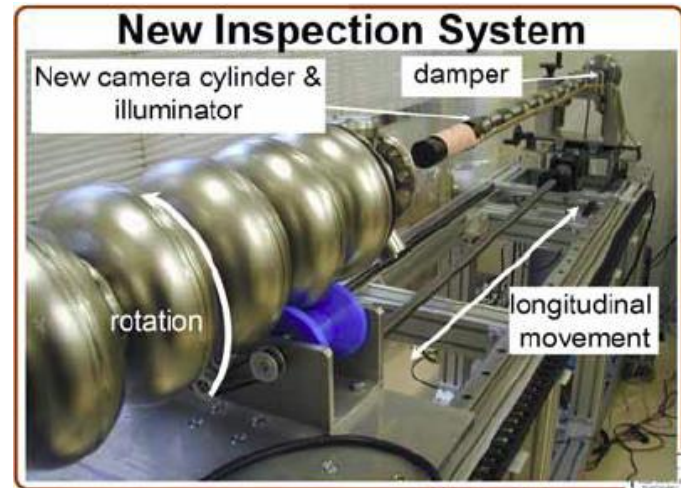

Cavity Tuning

Set-up for field profile measurements: a metallic needle is perturbing the RF fields while it is pulled through the cavity along its axis; the stored energy in each cell is recorded.

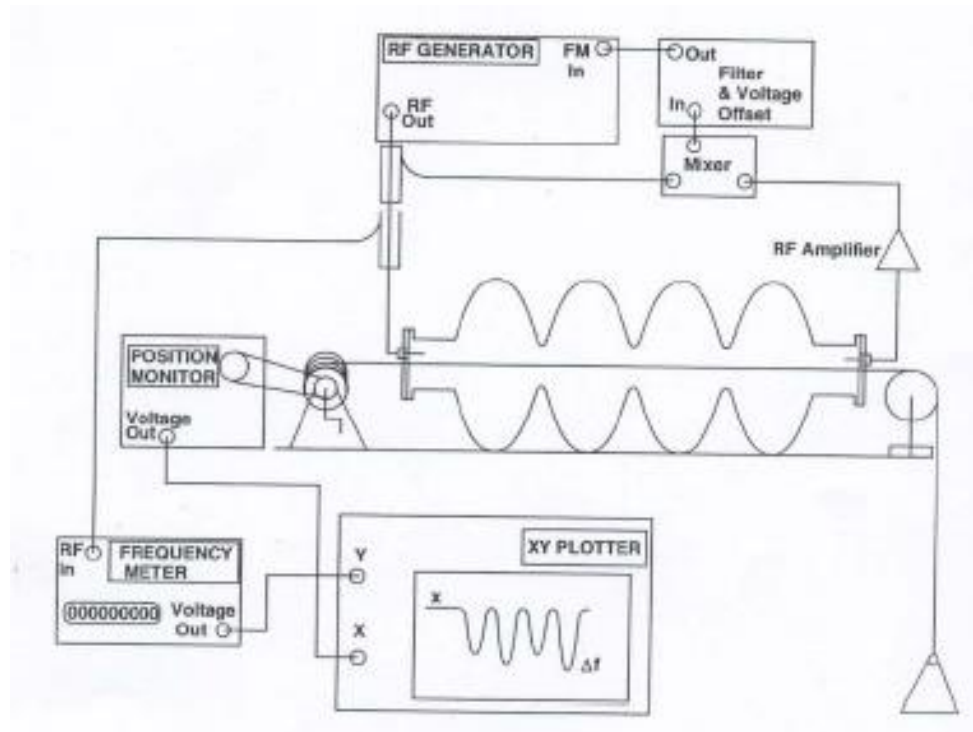

Cavity Tuning

- Small mechanical adjustments to the cavity's cells to obtain flat field profile and desired frequency

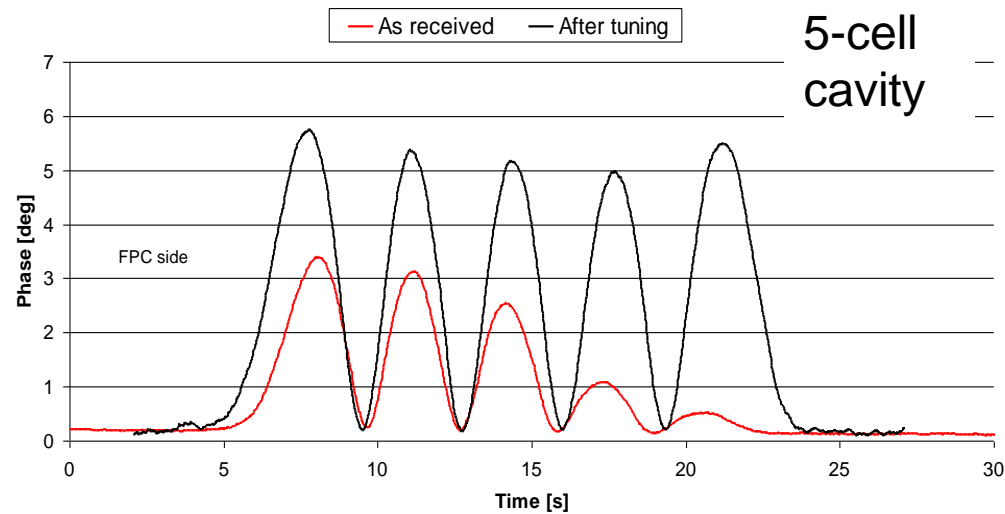
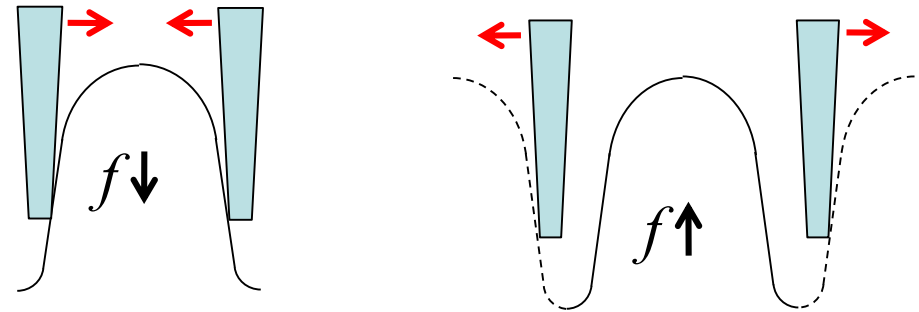
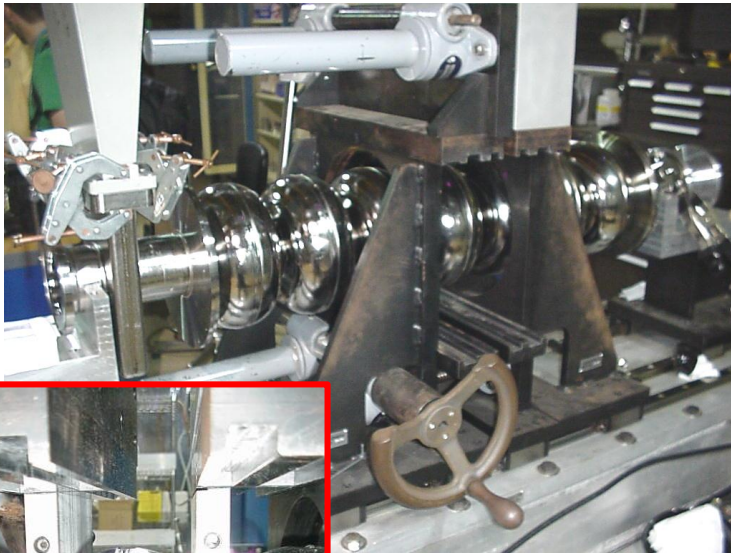

Cavity Tuning

Computerized tuning machine at DESY

- Equalizing stored energy in each cell
by squeezing or pulling
- Straightening of cavity



External Chemistry



Low- β Cavity Fabrication

Cavity components prior to EBW (AES)

The ANL 345 MHz Triple-spoke cavities

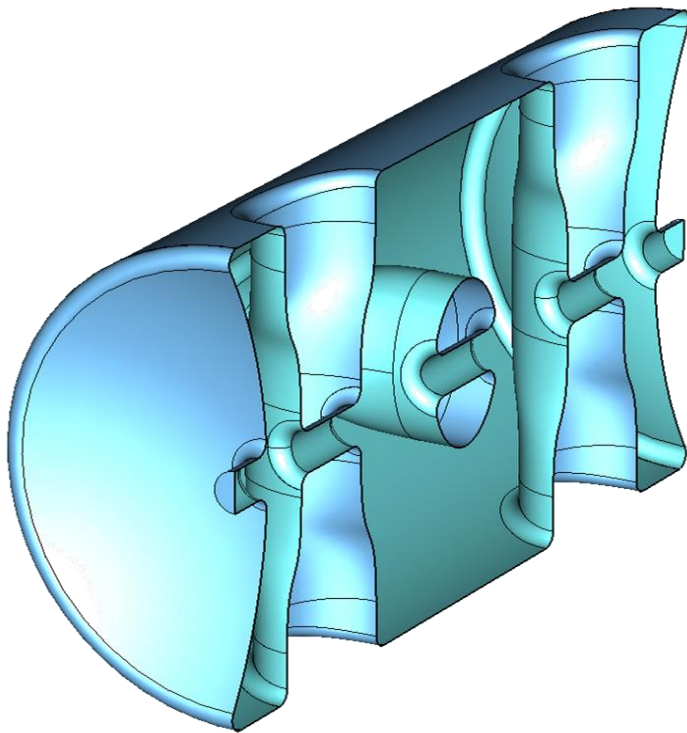

Low- β Cavity Fabrication

- Work out frequency tuning sequence to arrive at final frequency
– build into parts initial sizing
- Plastic deformation can be used after manufacture to achieve the final frequency
- Somewhat risky in jacketed cavity since pressure is put on the welds
- Flexible tuning plate can be deformed safely over some limited range without risk to cavity

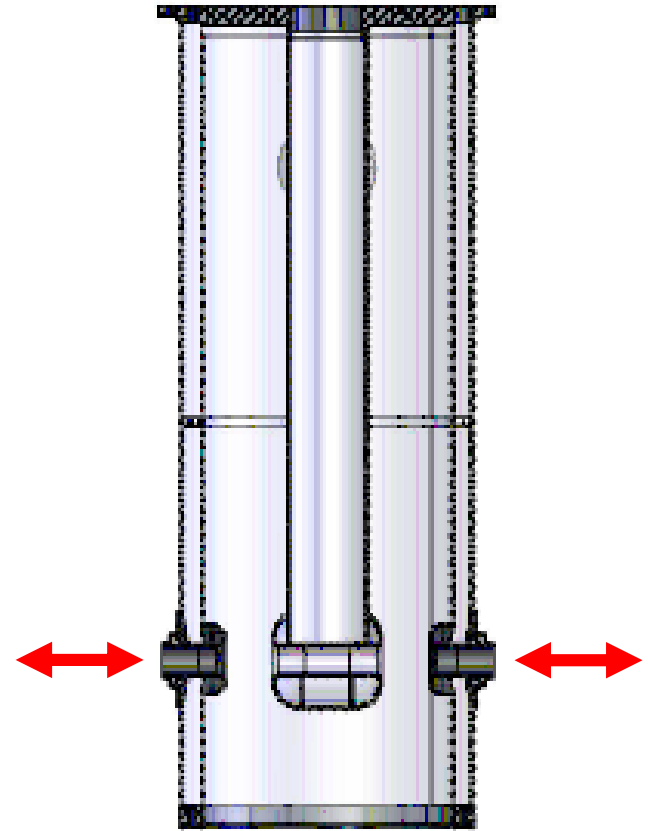

Cavity Fabrication R&D

- Large-grain/Single-crystal cavities
- Hydroforming
- Spinning

Large-Grain Nb

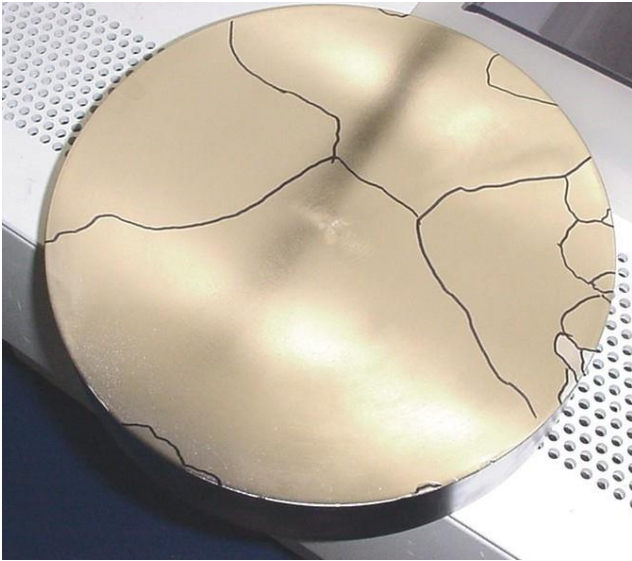

CBMM Large-grain Nb disc
RRR value: ~300
Ta content: ~500 ppm

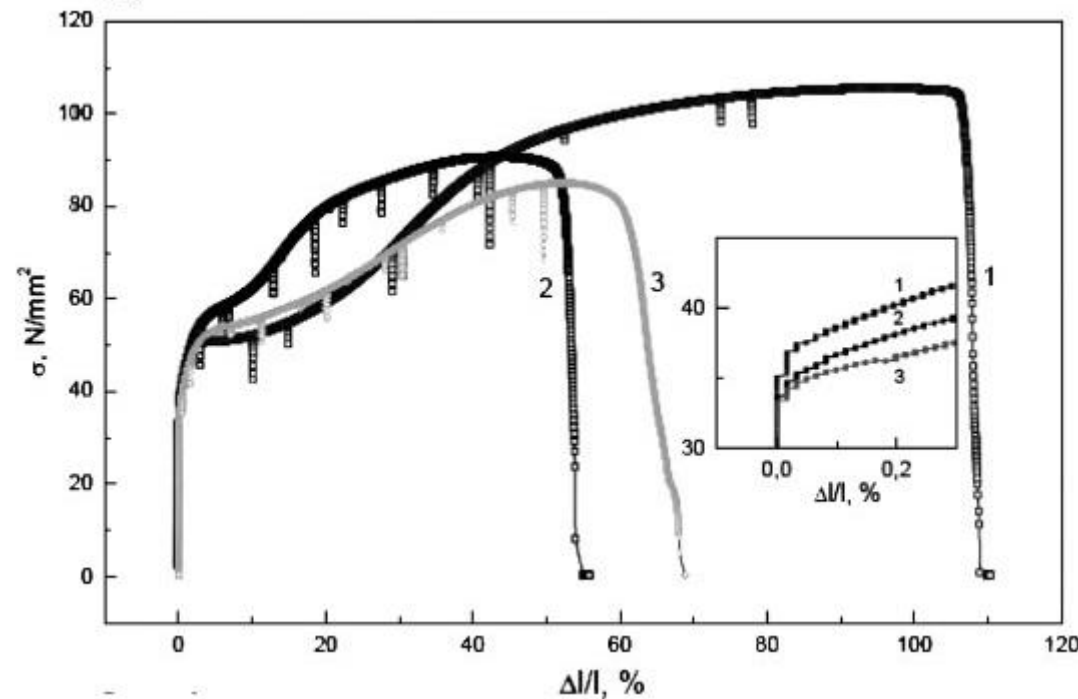
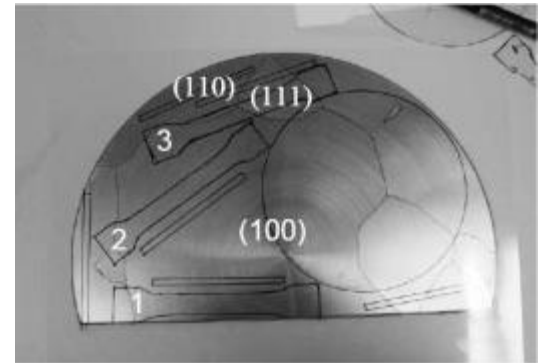
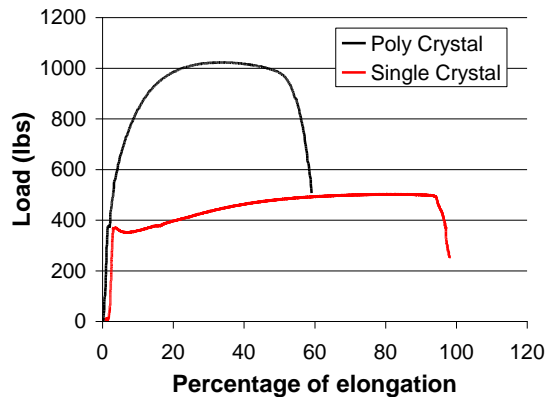



Large-Grain/Single-Crystal Nb Advantages

- Cost effective
- Reduced risk of contamination during sheet fabrication
- Simplified quality control
- Higher thermal conductivity at low temperatures (phonon peak)
- Smooth surfaces, comparable to EP, can be achieved by standard BCP
- Baking at 120°C works to reach high-fields

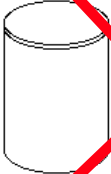
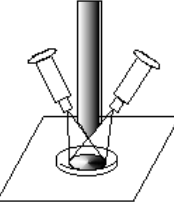
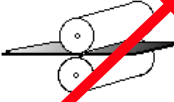
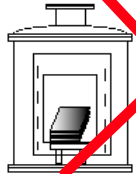
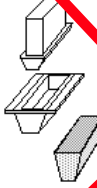
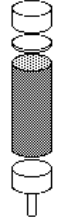
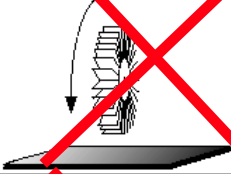
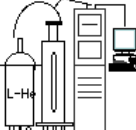
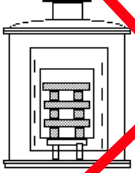
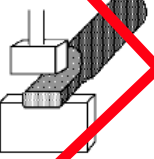
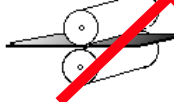

Large-Grain Nb Sheets

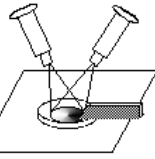
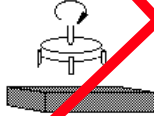
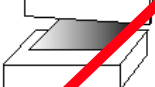
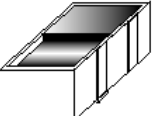
 <p>1. Mother Material</p>	 <p>5. EB Melting (2nd, 3rd)</p>	 <p>9. Rolling</p>	 <p>13. Annealing</p>
 <p>2. Pressing</p>	 <p>6. Cutting</p>	 <p>10. Polishing</p>	 <p>14. Testing</p>
 <p>3. Out gassing and Sintering</p>	 <p>7. Forging</p>	 <p>11. Rolling</p>	 <p>15. Polishing</p>
 <p>4. EB Melting(1st)</p>	 <p>8. Mechanical grinding</p>	 <p>12. Cutting</p>	 <p>16. Packing</p>

Material Suppliers

- Fine-Grain:
 - Tokyo Denkay (Japan)
 - ATI Wah Chang (USA)
- Large-Grain:
 - Tokyo Denkay (Japan)
 - ATI Wah Chang (USA)
 - OTIC (China)
 - CBMM (Brazil)
 - WC Heraeus (Germany)

Ingots Slicing

Successfully Multi-sliced 59 sheets (3.2t) from 201 mm long Nb Ingot

- Wire EDM (slow)
- Diamond saw
- Multi-wire

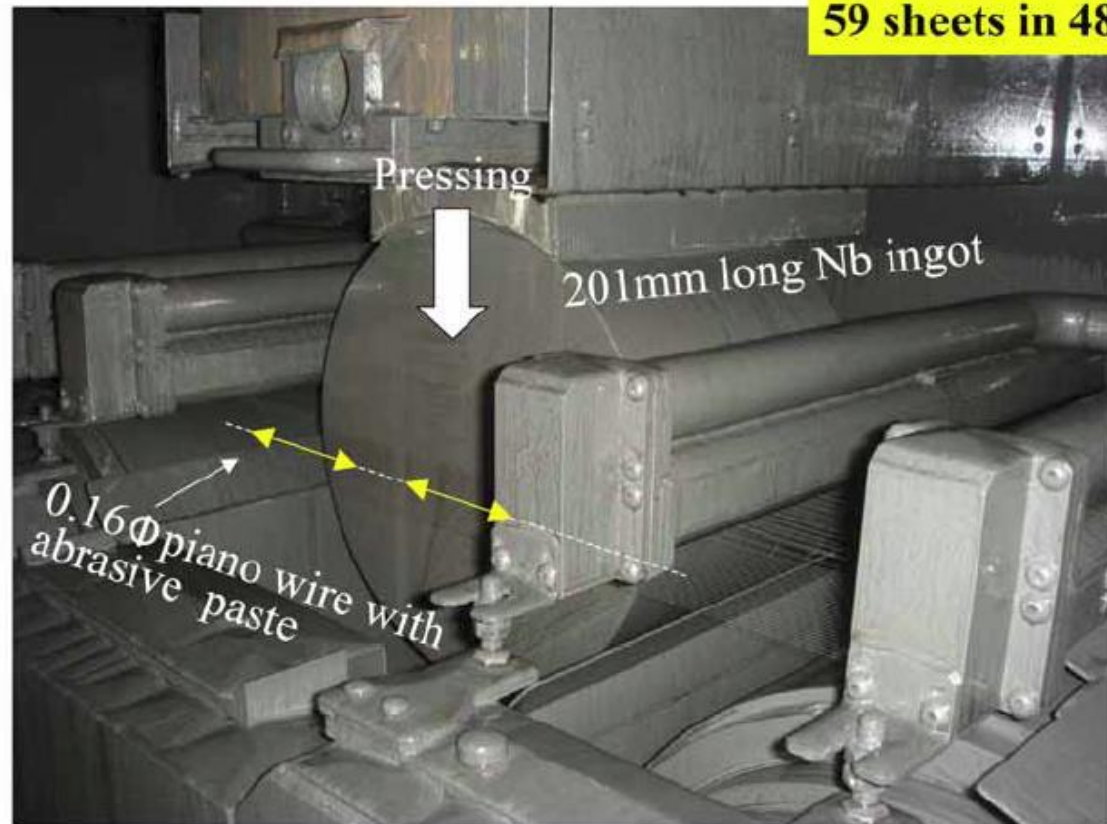

Large-grain Nb sheets are available up to 18" diameter

Deep Drawing Large-Grain Nb

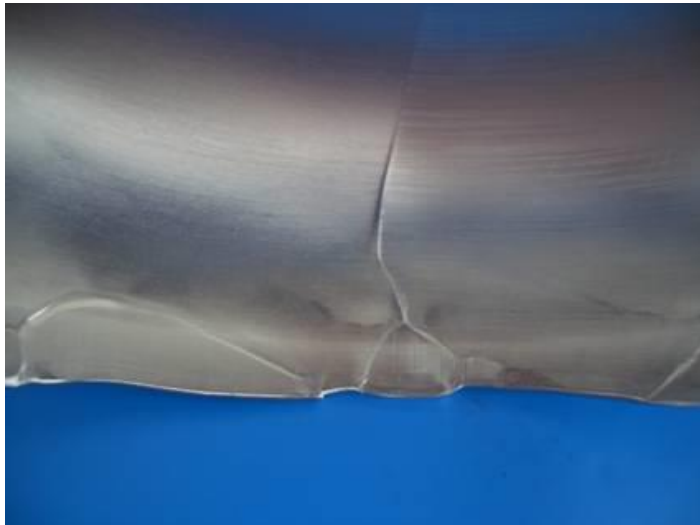

- Non-uniformity in the equator area
- Visible steps at grain boundaries
- Thinning at iris region if there is no large single crystal at the center

Large-Grain Nb Cavity Fabrication



- Same procedures as fine-grain Nb
- Assembly for equator welds a bit more complicated as cells are not as round as fine grain cells



Large-Grain Single-Cell Studies

OTIC, RRR ~ 330

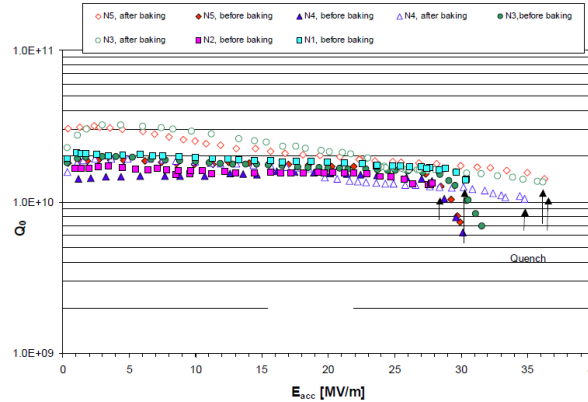

$$\langle B_p \rangle = 141 \text{ mT} \pm 10\%$$

WC Heraeus, RRR ~ 500

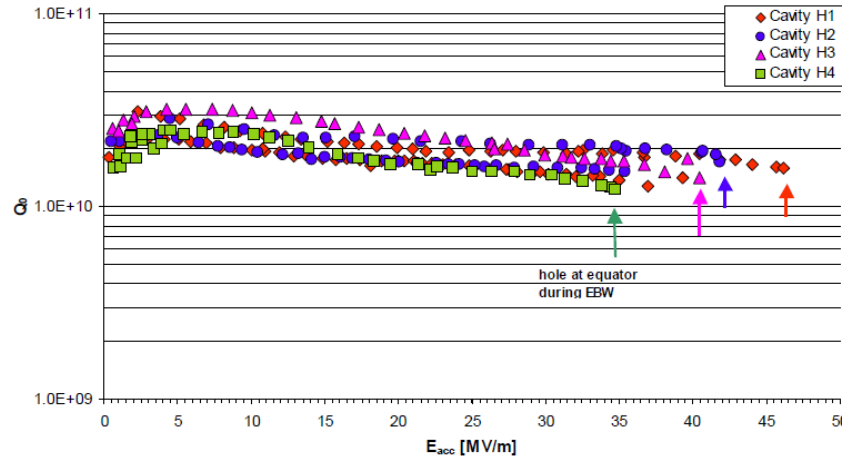
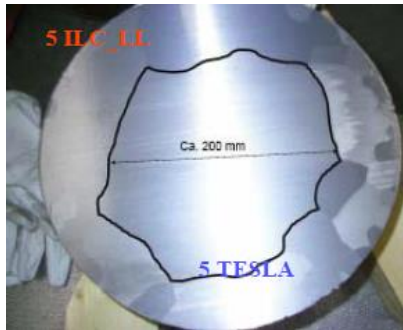

$$\langle B_p \rangle = 147 \text{ mT} \pm 13\%$$

CBMM, RRR ~ 280

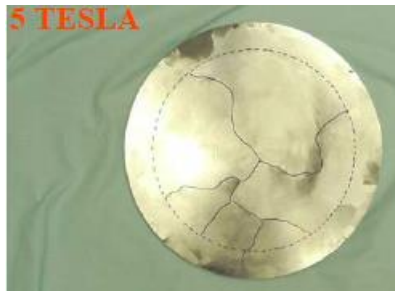

Large-Grain 9-Cell Results

AC114 AC113 AC114 baked AC113 baked

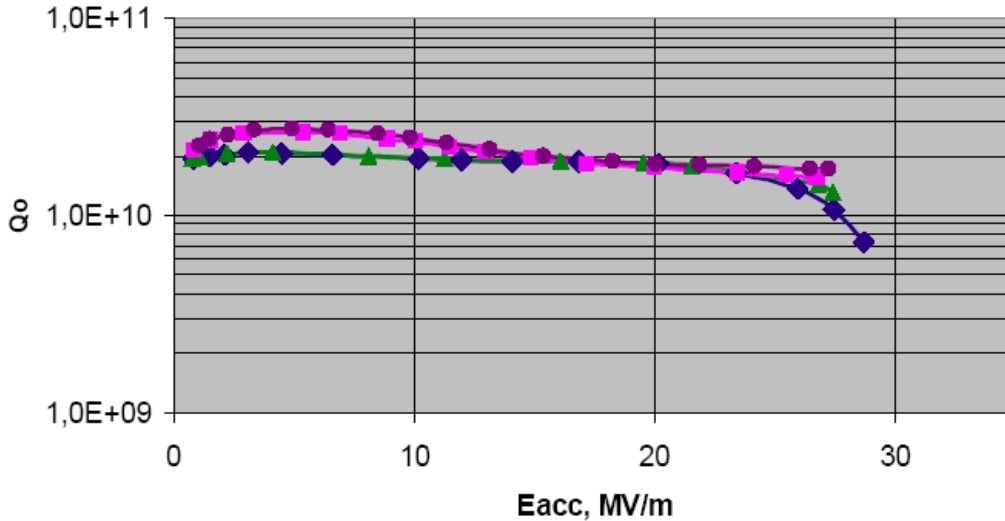

- 11 Large-Grain 9-cell cavities at RI from Heraeus material

After 120 μm BCP & baking

AC113, add 50 μm EP AC112, add 230 μm EP AC114, add 100 μm EP

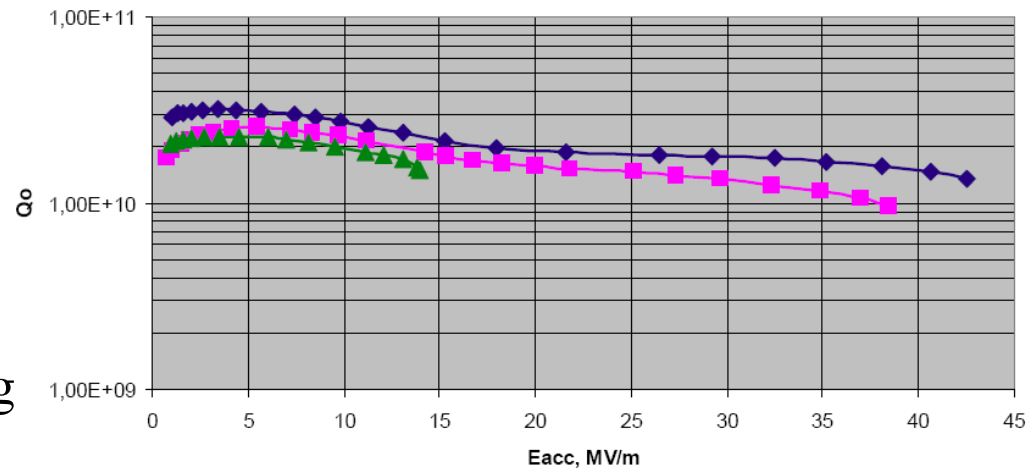

After additional EP & baking

Single-Crystal Nb Cavity Fabrication

Single crystal cavity fabrication (DESY- JLab)

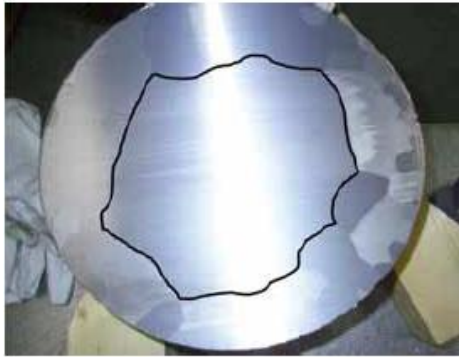

1. Take out central single crystal of definite thickness

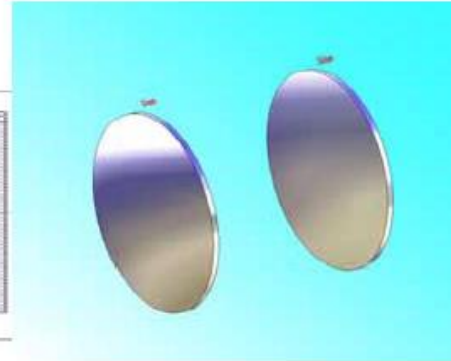

2. Cutting through the disc



3. Increasing of diameter by special rolling with an intermediate annealing

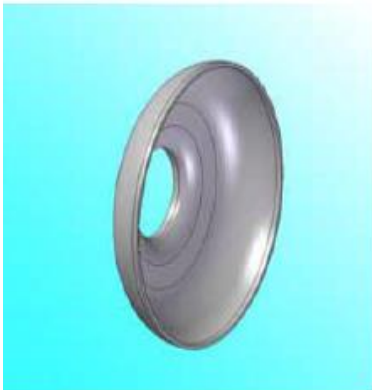

4. Deep drawing

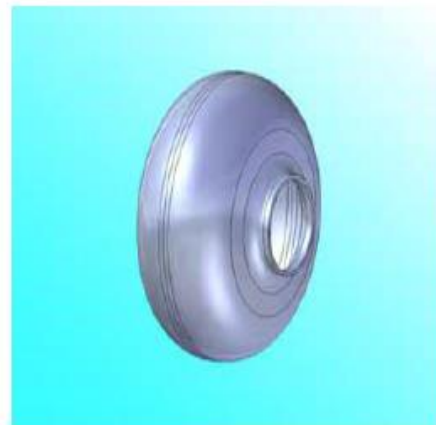

5. EB welding by matching the crystal orientation



Single Crystal Cavities with three different crystal orientation

Single-Crystal Nb Cavity Results

Cavity #	$E_{\text{acc,max}}$ (MV/m)	$B_{\text{peak,max}}$ (mT)	$Q_0(B_{\text{peak,max}})$	Treatment
1	38	162	4×10^9	200 μm BCP, 800°C 3h, HPR, 120°C 48h
2	45	160	7×10^9	200 μm BCP, 800°C 3h, HPR, 120°C 24h
3 (1AC6)	41	177	1.2×10^{10}	250 μm BCP, 750°C 2h, 120 μm EP, HPR, 135°C 12h
4 (1AC8)	38.9	168	1.8×10^{10}	216 μm BCP, 600°C 10h, HPR, 120°C 12h
5	38.5	166	7.6×10^9	170 μm BCP, HPR, 120°C 12h

Single-Crystal Nb Cavities

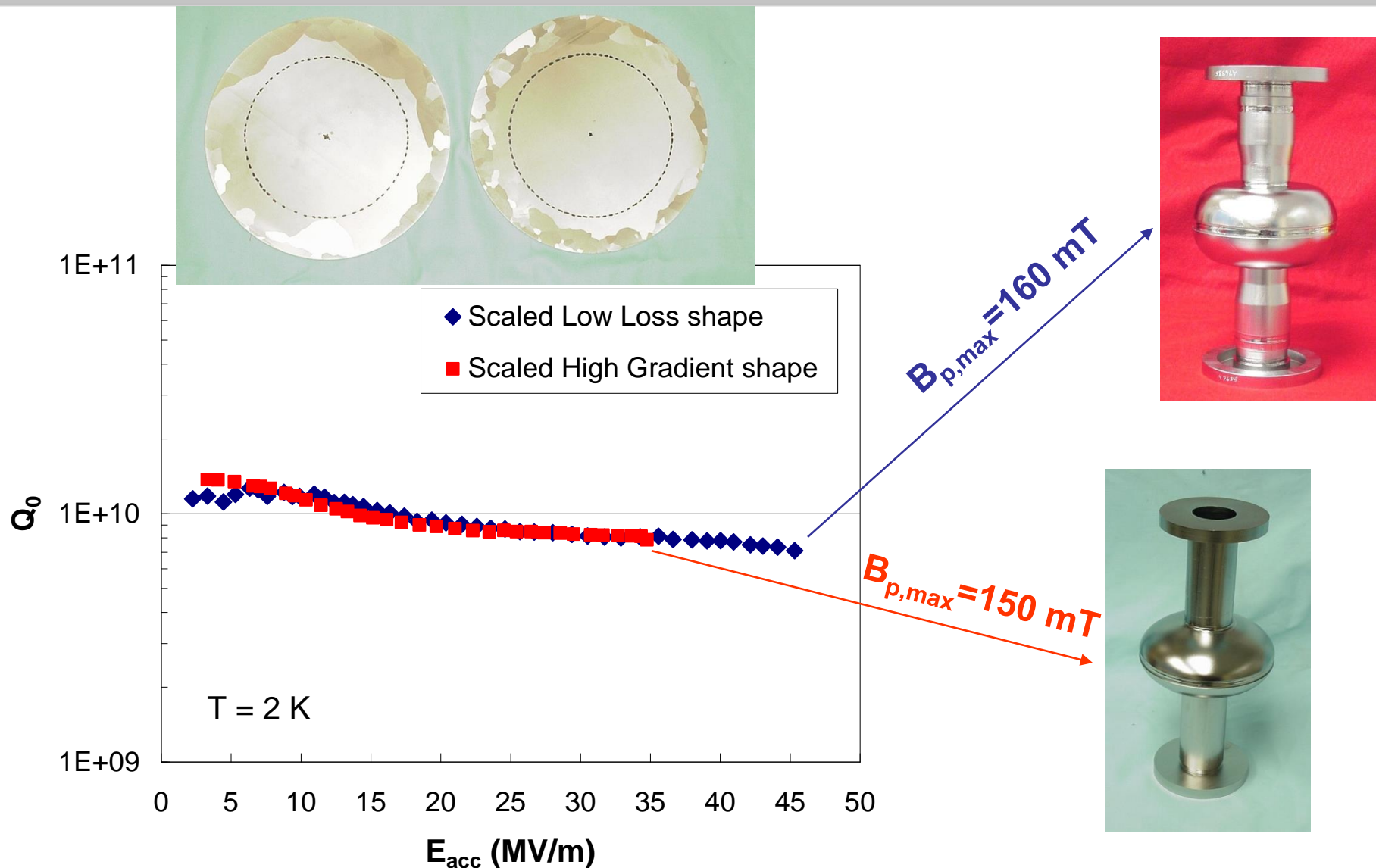

Seamless Cavities

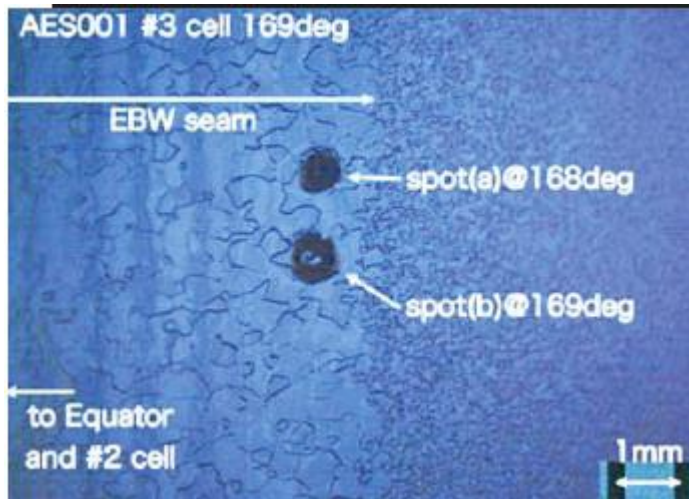

- Eliminate equator welds and associated problems
- Cost effective

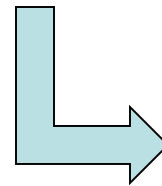

- **Hydroforming**
- **Spinning**

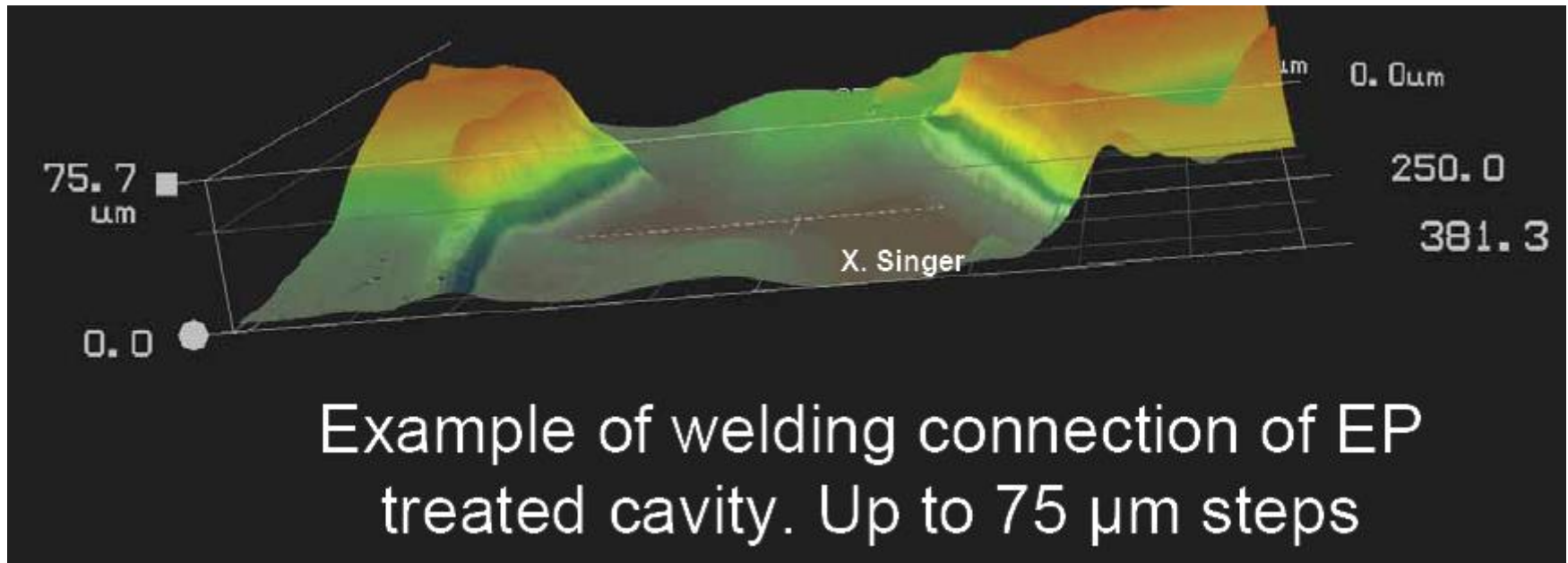

Hydroforming



- Tube of intermediate diameter between iris and equator
- Necking to form iris area
- Hydroforming (hydraulic expansion)

Tube Forming: Fine-Grain Nb

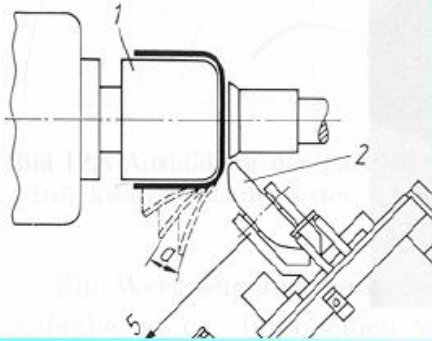

Pot with thick wall by spinning (or deep drawing)

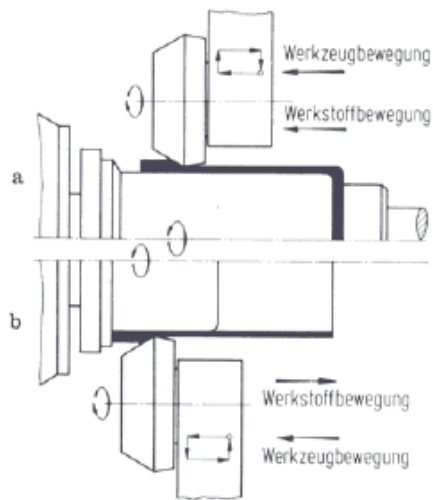

Flow forming

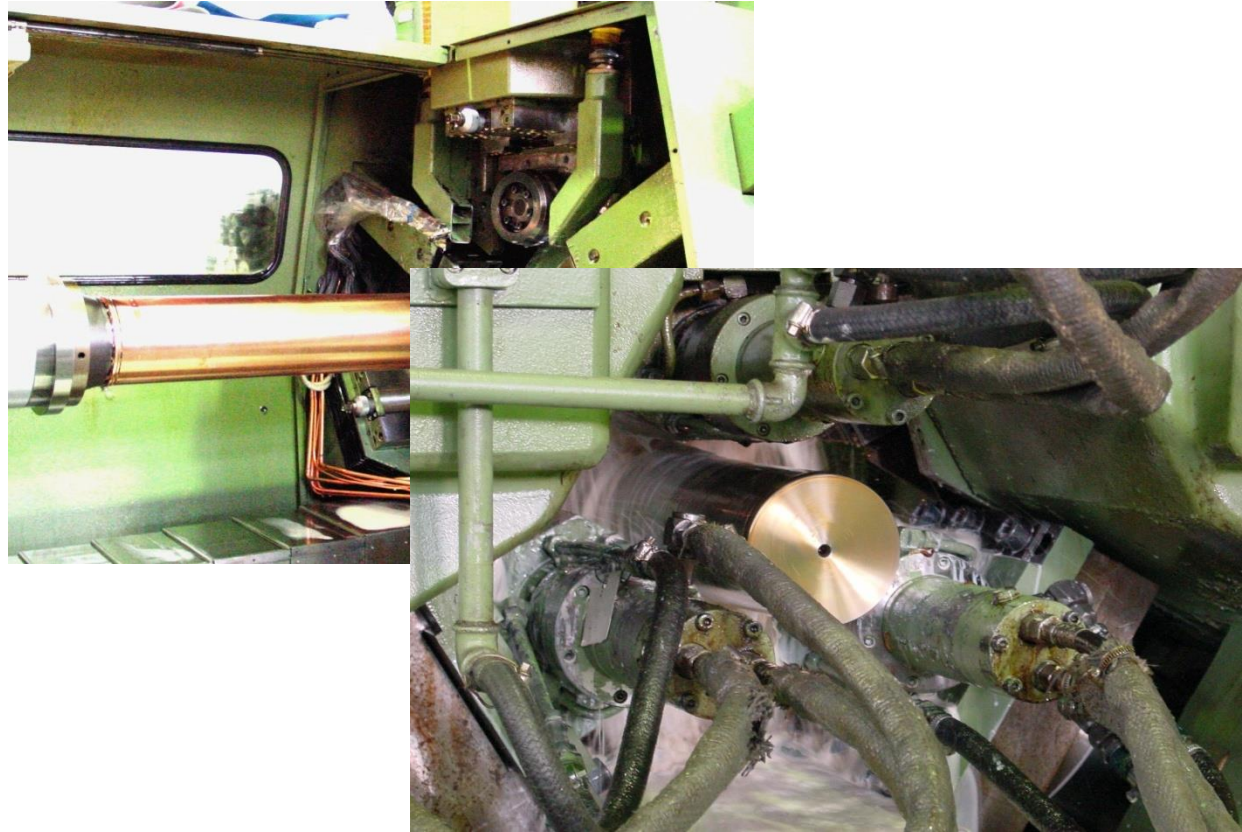

Flow forming over a cylindrical mandrel with three work rollers allows to produce long and very precise tubes from thick walled cylindrical part.

After optimization of several parameters shiny Nb surface and small wall thickness variations (less than $\pm 0,1$ mm) have been achieved.

Tube Forming: Fine-Grain Nb

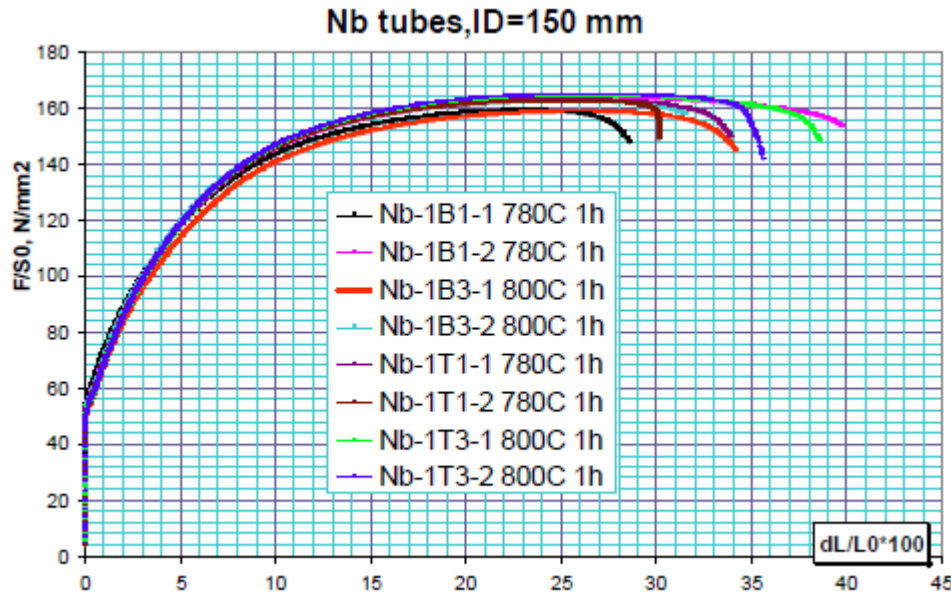

- Small and uniform grains
- Elongation at break > 30%

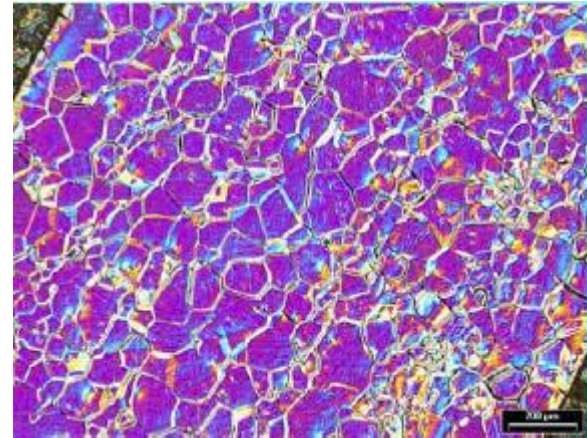

Tube Forming: Single-Crystal Nb

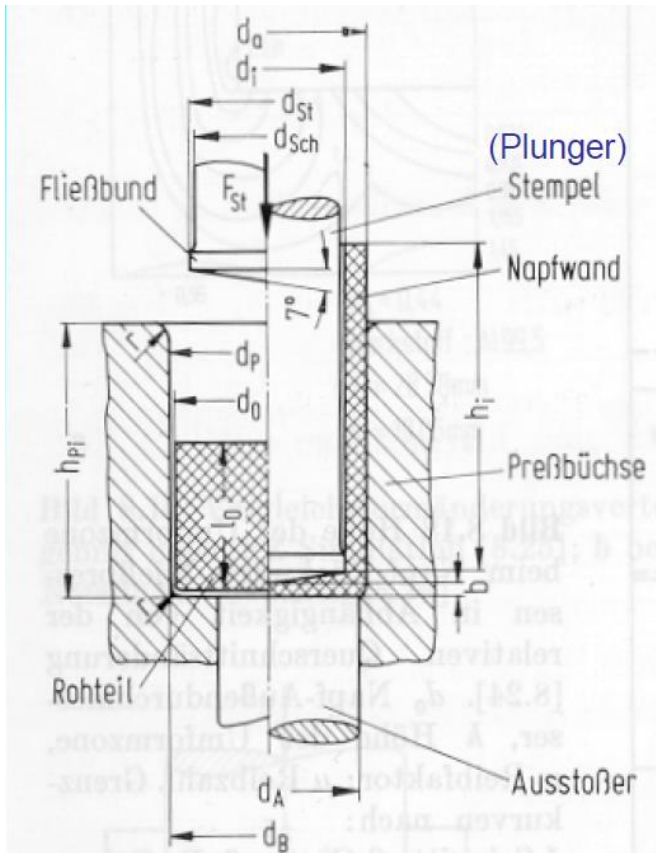

Seamless single-crystal tube by back extrusion

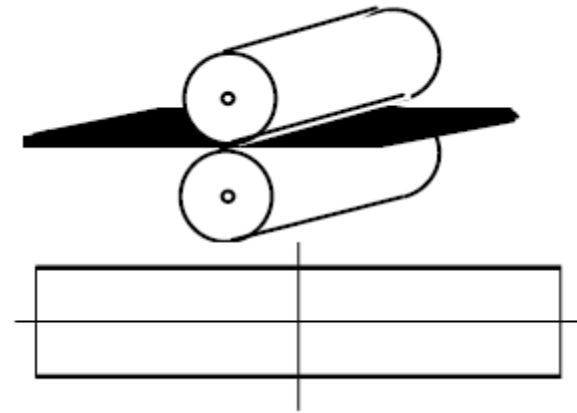

- Welded single-crystal tube:
 - Rolling of single-crystal with intermediate annealing
 - EBW with matching of the orientation

Necking

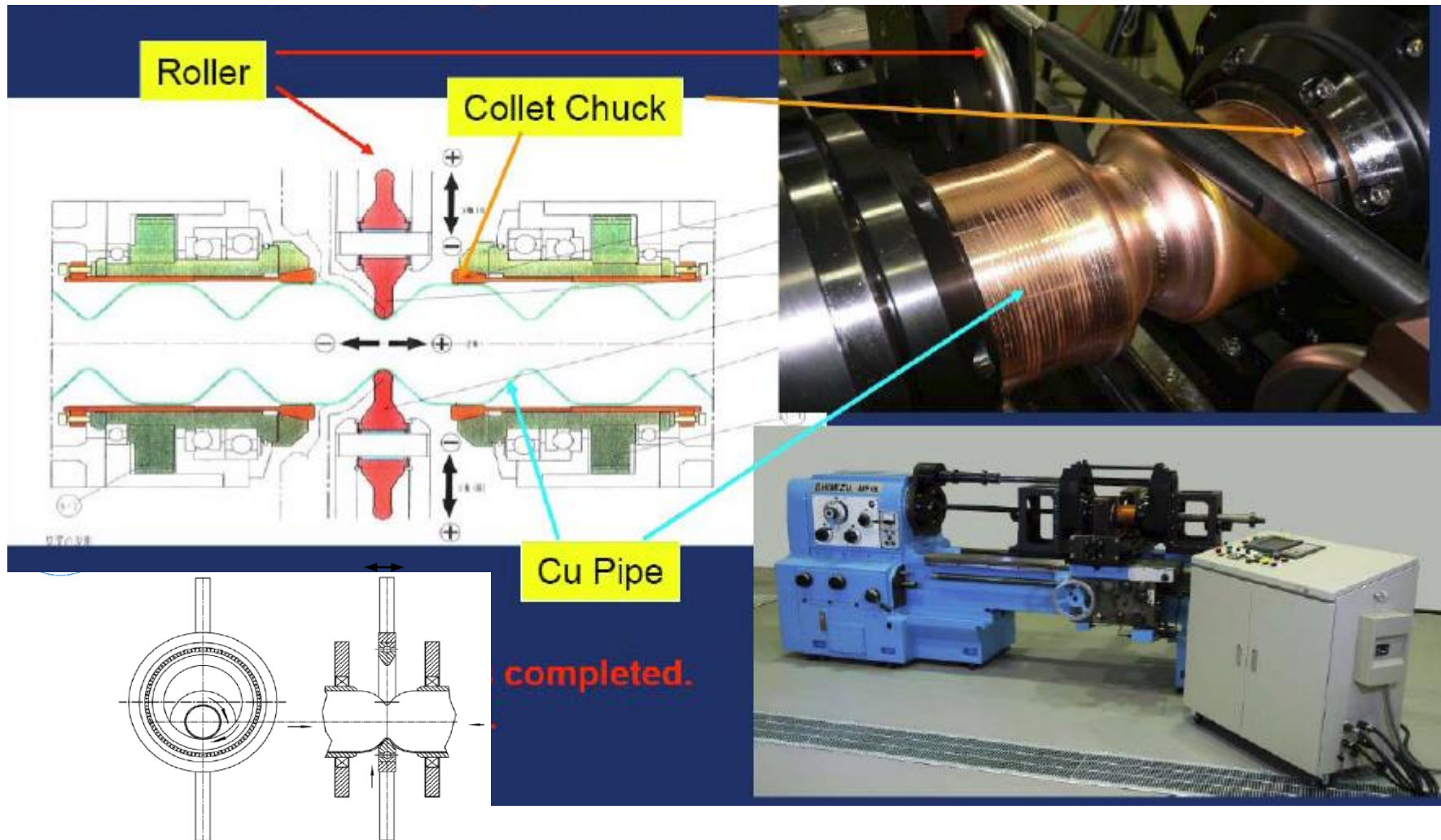

Principle of diameter reduction in the tube end and in the tube middle

Hydroforming

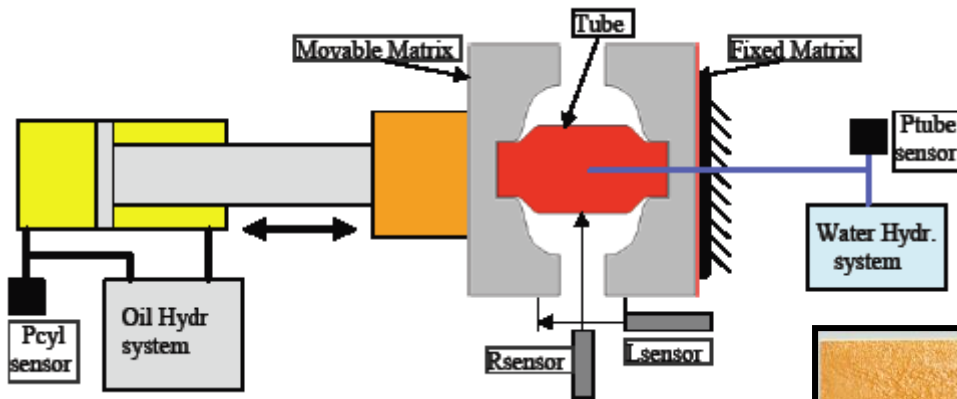

Relies on the correct relationship between applied internal pressure and axial displacement (strain rate) to remain below the plastic limit

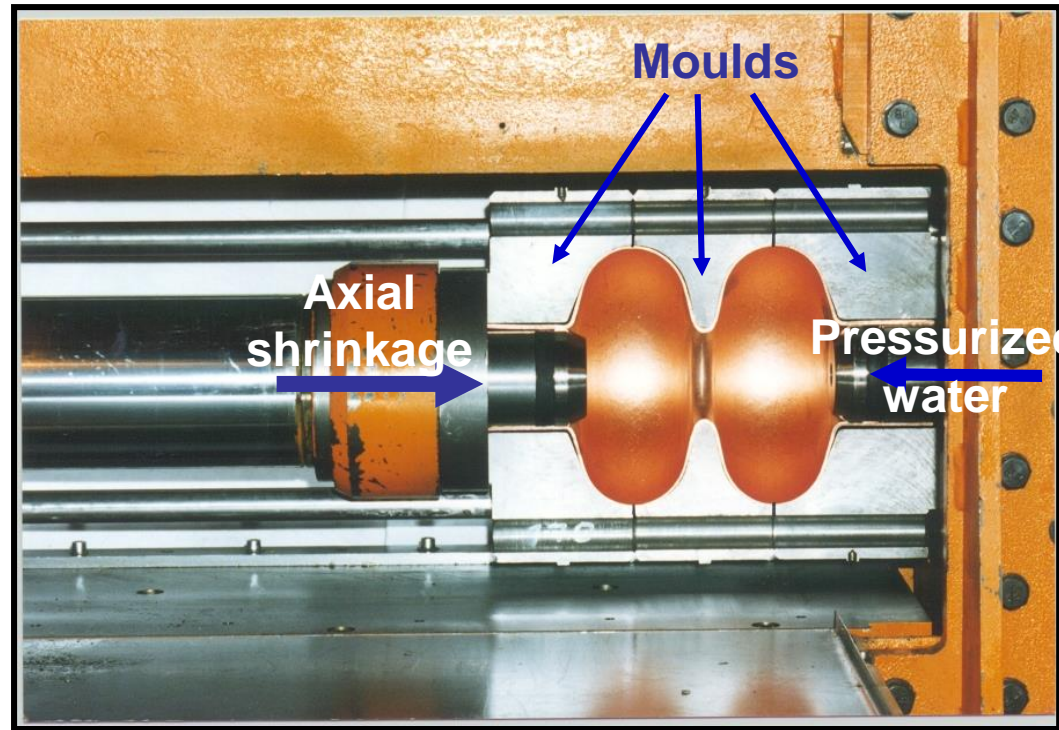

Hydroforming

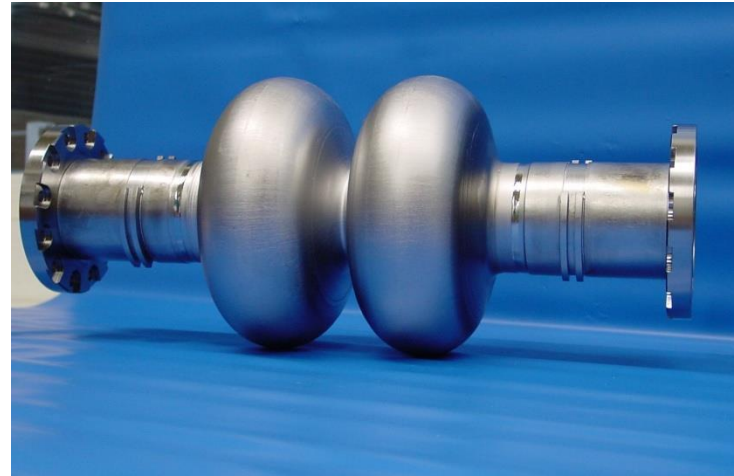
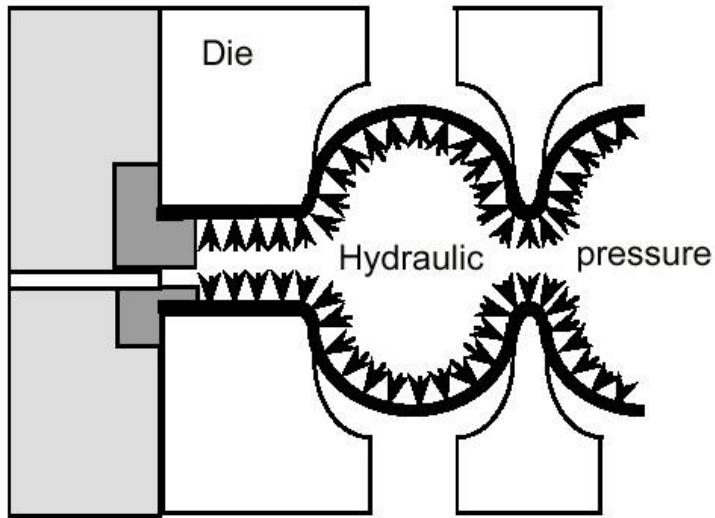

DESY hydroforming machine

Hydroforming: Cavity Results

Hydroformed single cell Nb cavity 1K2

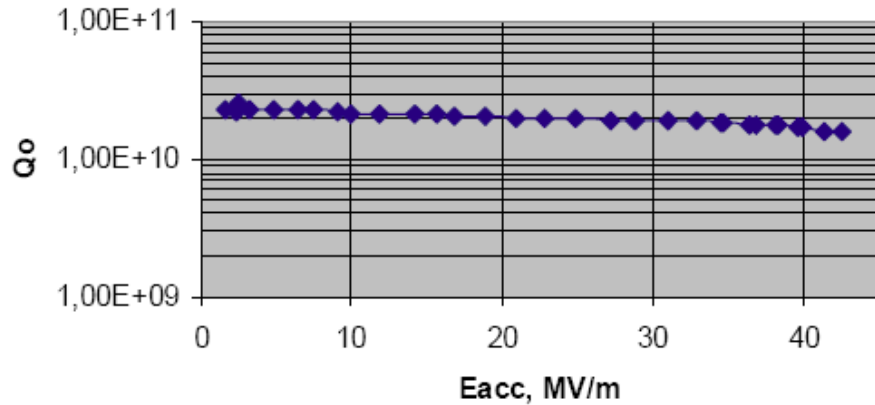

◆ 1K2, Nb100 Heraeus, HT1400°C, BCP 250 μm, EP 100μm



Hydroformed 9-cell cavity Z145

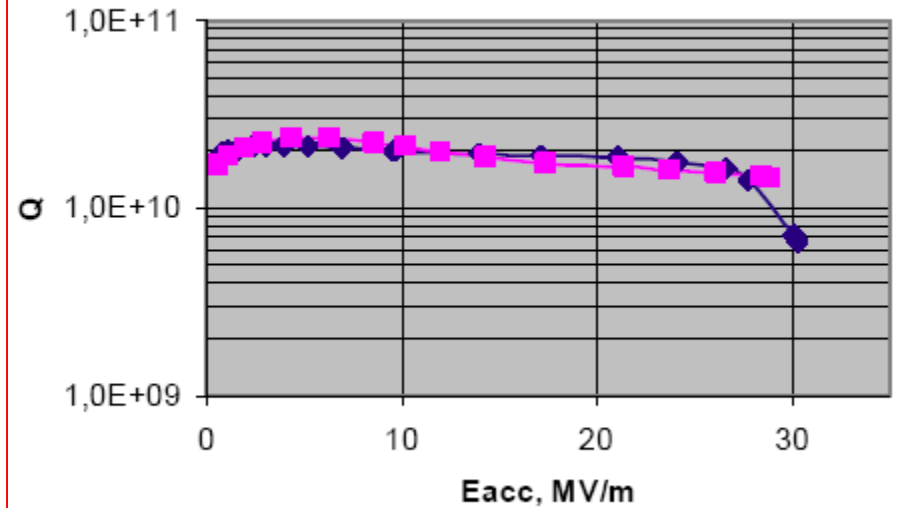

◆ EP170μm; 800°C, 2h; EP48μm ■ add. baking 120°C, 48 h

Spinning

- Starting from discs or seamless tubes
- Collapsible mandrels
- Very rough surface after fabrication

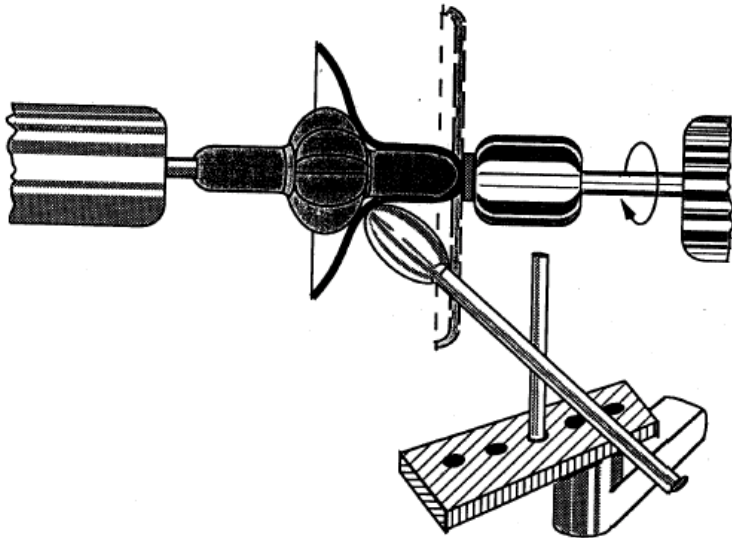

Spinning

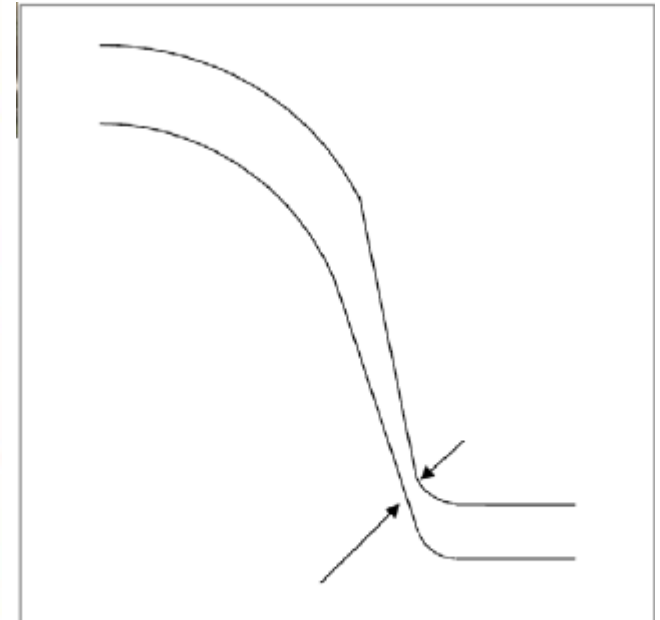
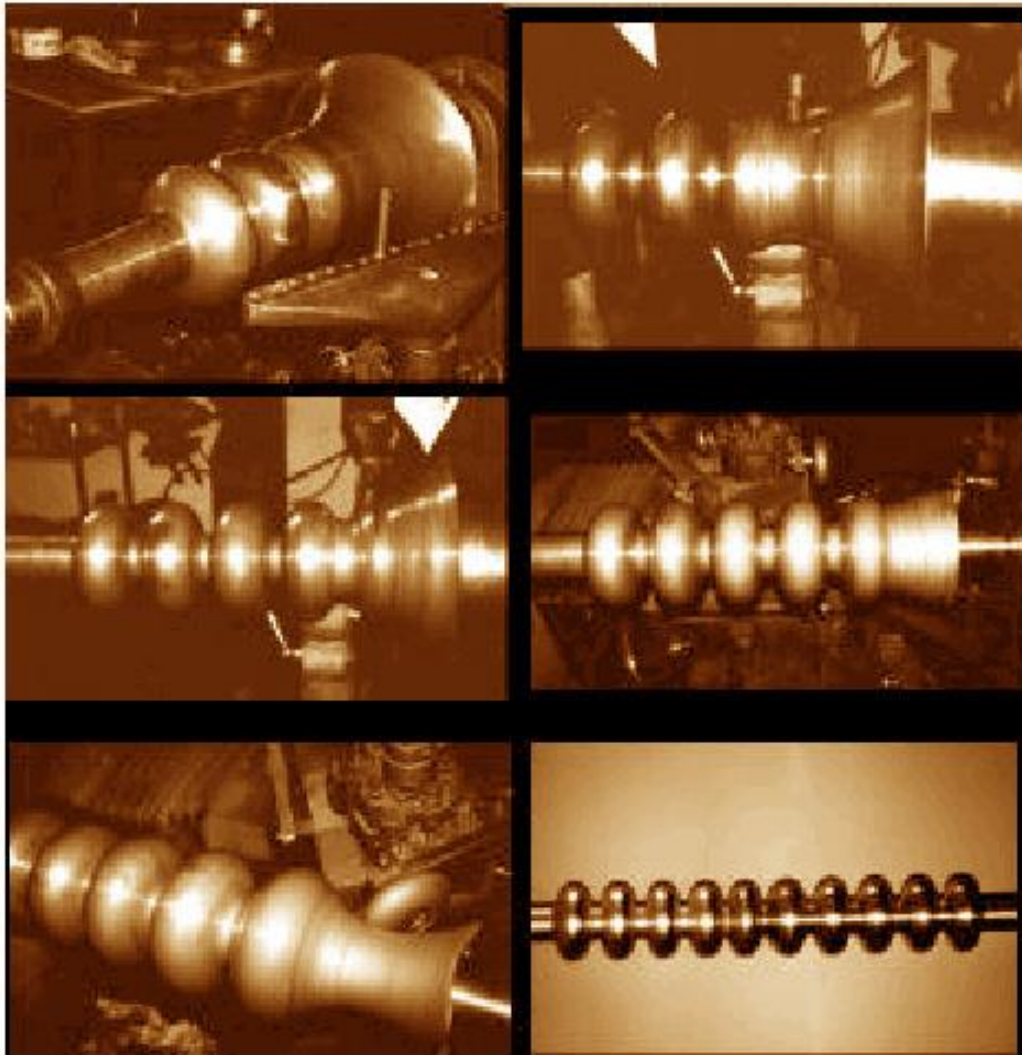

The problem of excessive thinning at the terminal iris

Spinning: Cavity Test Results

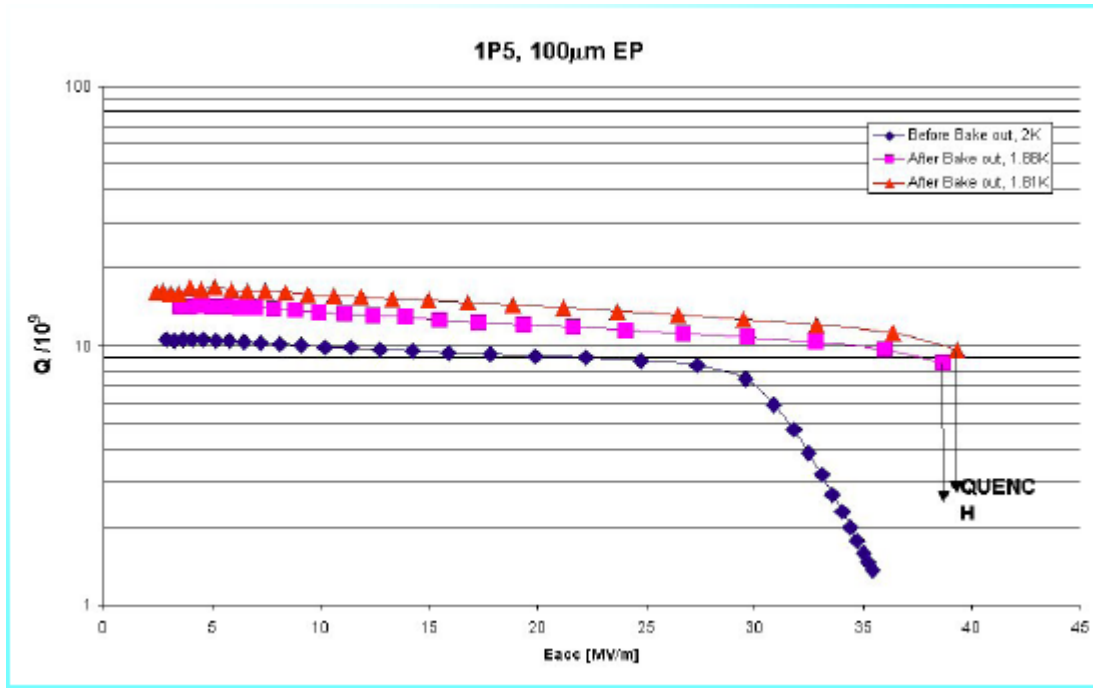

1.3 GHz single-cell cavity



1.3 GHz 9-cell cavity.
Damaged after CBP, no test

Spinning: Cheap Sample Cavities

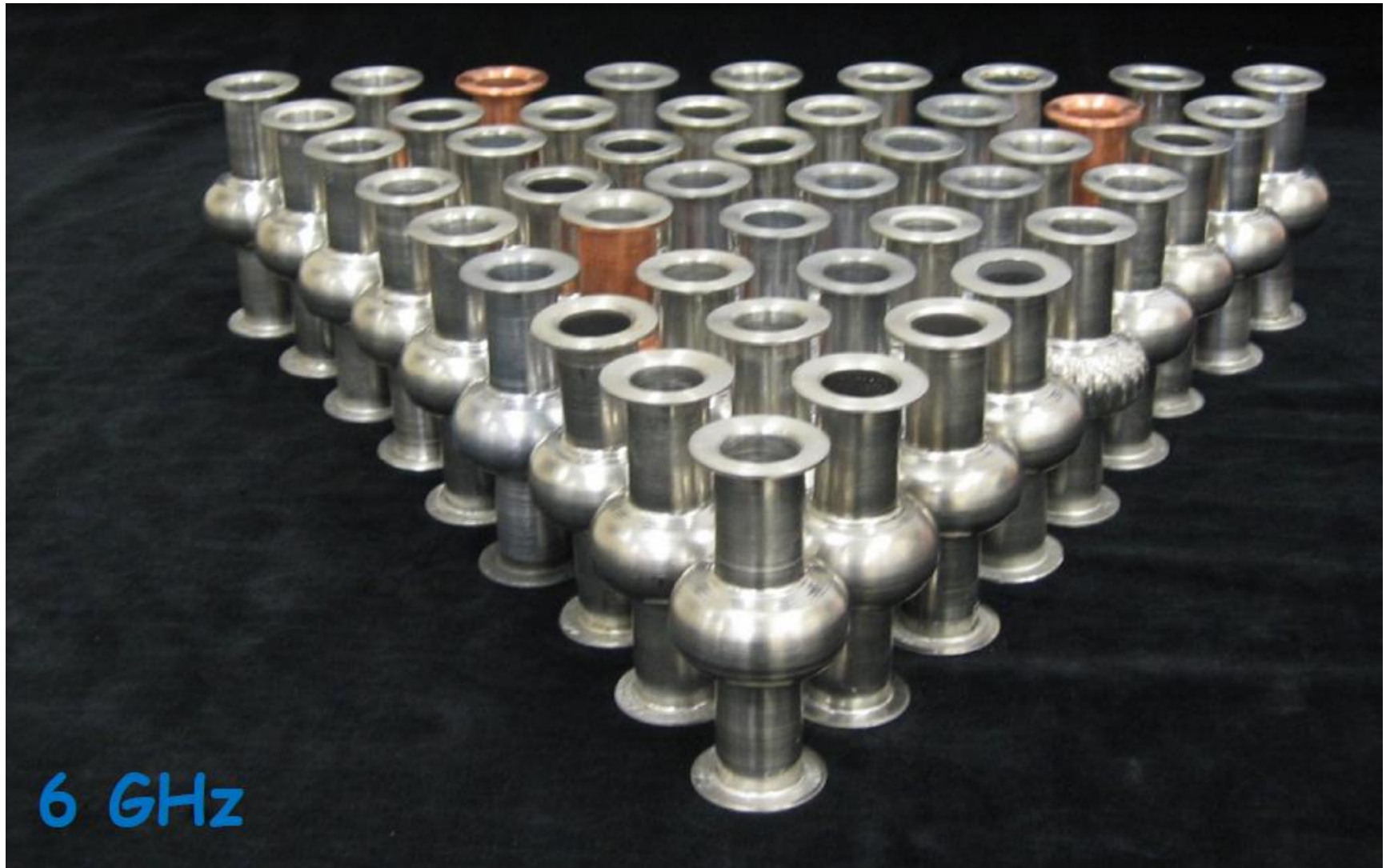

Nb/Cu Clad Material

Advantages

- cost effective: allows saving a lot of Nb (ca. 4 mm cavity wall has only ca. 1 mm of Nb and 3 mm Cu). Especially significant for large projects like ILC
- bulk Nb microstructure and properties (the competing sputtering technique does not have such advantages)
- the treatment of the bulk Nb BCP, EP, annealing at 800°C, bake out at 150°C, HPR, HPP can be applied (excluding only post purification at 1400°C).
- high thermal conductivity of Cu helps for thermal stabilization
- stiffening against Lorentz - force detuning and microphonics can be easily done by increasing of the thickness of Cu layer.
- fabrication by seamless technique allows elimination of the critical for the performance welds especially on equator

W. Singer SRF 2005

Nb/Cu Clad Cavity Fabrication

- Nb/Cu laminated material is formed into a tube by:
 - Explosion bonding
 - Back extrusion
 - Hot bonding
- Nb/Cu clad cavity is formed from the tube by hydroforming
- Beam tubes/End groups are welded to the thin Nb layer by EBW. The Cu backing must be removed and cleaned at the weld joints

Nb/Cu Tubes: Explosion Bonding

- Explosion bonding of seamless Nb tube 4 mm thick with Cu tube 12 mm thick
- Flow forming into Nb/Cu tube, wall thickness 1 mm Nb, 3 mm Cu

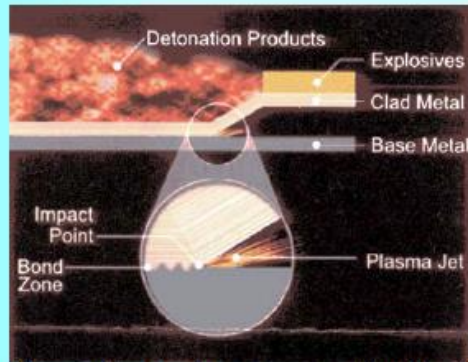

Explosively bonded NbCu tube

The bonding takes place by an explosively driven, high-velocity angular impact of two metal surfaces.



Flow forming of NbCu tube

W. Singer SRF 2005



After flow forming

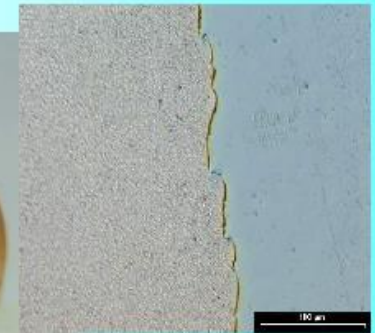

Structure of Nb/Cu interface

Nb/Cu Clad Cavities

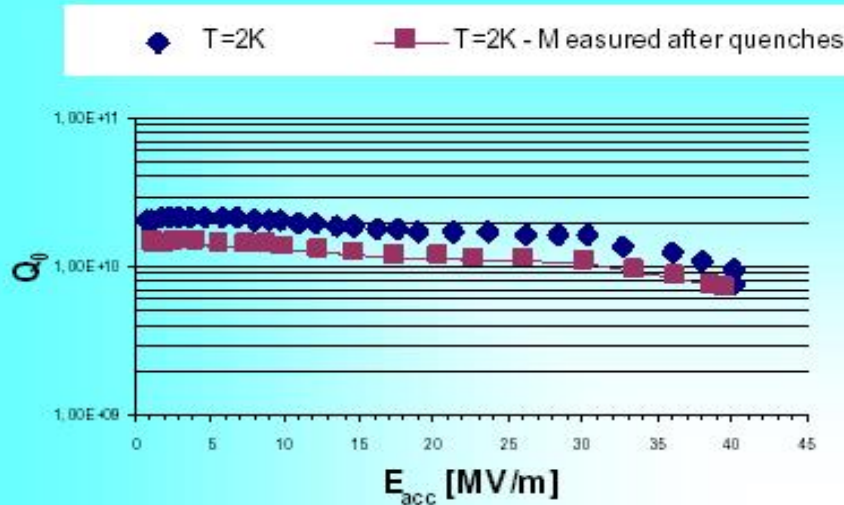

NbCu cavities hydroformed from explosively bonded tubes at DESY.

NbCu single cell cavity INC2 produced at DESY by hydroforming from explosively bonded tube. Preparation and HF tests at Jeff. Lab: 180 μ m BCP, annealing at 800°C, baking at 140°C for 30 hours, HPR (P. Kneisel).

Difficult to get reproducibly high bonding quality. Hot bonding fabrication procedure of NbCu tubes seems to be more promising

40 MV/m without EP

W. Singer SRF 2005

Nb/Cu Tubes: Hot Bonding

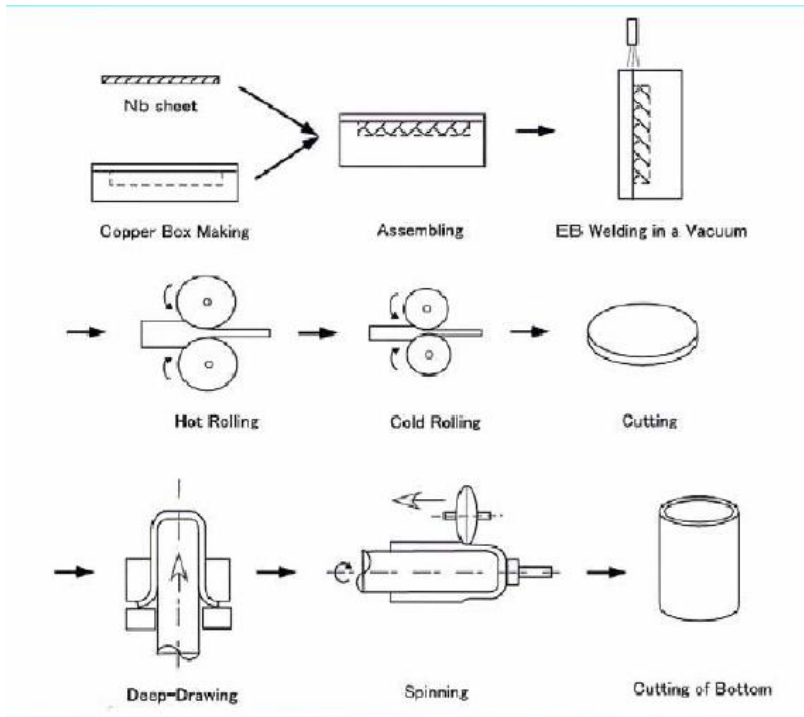

Fabrication principle of sandwiched hot rolled Cu-Nb-Cu tube (KEK and Nippon Steel Co.)

Hot roll bonded Cu-Nb-Cu tube produced at Nippon Steel Co.

Nb/Cu Clad Cavities



Single-cell Nb/Cu cavities from
“sandwiched” tube



Four double cell NbCu clad cavities
produced at DESY from KEK tubes
(no cracks on the inside surface)

Hot roll bonded tube fabrication at
Nippon Steel Co., hydroforming at DESY,
Preparation and RF tests at KEK

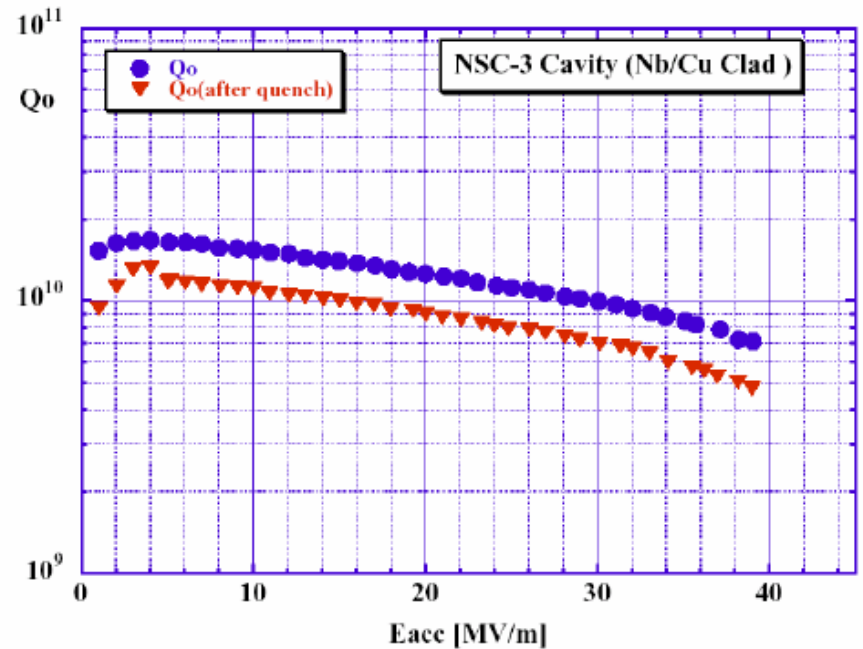

NSC-3: Barrel polishing, CP(10 μm),
Annealing 750°C x 3h, EP(70 μm) K.Saito

Nb/Cu Clad Cavities Issues

- Possibility of leaky welds because of Cu contamination
- Nb/Cu cavities still quench, resulting in Q-degradations
- Cooldown needs to be very uniform because of thermo-currents
- Cooldown of cryomodules would need modification
- Cracks sometimes appear in iris region during fabrication