



Lecture 1

Introduction to Accelerators: Evolution of Accelerators and Modern Day Applications

S. Cousineau, J. Holmes, R. Potts, Y. Zhang

USPAS
January, 2014



What are accelerators used for?

Discovery Science

- Particle and Nuclear Physics
- Materials science, chemistry, biology, ...



Energy and Environment

- accelerator-driven reactors (future)
- Inertial confinement fusion with heavy-ions (future)
- Flue-gas treatment

Medicine

- Cancer therapy
- Medical radioisotopes



Accelerators and Beams



National Security

- Cargo screening
- Active interrogation
- Radiography



Industry

- Electron processing
- Sterilization
- Ion implantation





Accelerators by the Numbers

Application	Systems (thru 2008)
Ion Implantation	10,000
Electron beam modification	7,000
Electron and X-ray irradiators	2,000
Ion beam analysis and AMS	200
Radioisotope production	600
High energy x-ray inspection	750
Neutron generators	2000
Radiotherapy	8000
Hadrontherapy	25
Photon Sources (synchrotron radiation, ...)	80
Nuclear and Particle Physics Research	110
Total	~30,000

The most well known category of accelerators – particle physics research accelerators – is one of the smallest in number. The technology for other types of accelerators was born from these machines.



Nuclear and Particle Physics

- Much of what we know about the subatomic world is from experiments enabled by particle accelerators.
- The first “high-energy” accelerator, made by Cockroft and Walton, was immediately used to understand the atomic nucleus. They made the first artificially produced nuclear reaction:

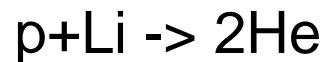

- Early accelerator developments were driven by the quest for higher and higher particle energies, which in turn was driven by developments in nuclear physics (through the 1960s) and then elementary particle physics (1960s-onward)
- The largest accelerator is at CERN. It will collide two proton beams of energy 7 TeV each.



Energies in the atomic and subatomic world

- Energies are measured in electron-volts: eV
And eV is the amount gained by an electron accelerated across a 1 Volt potential difference.

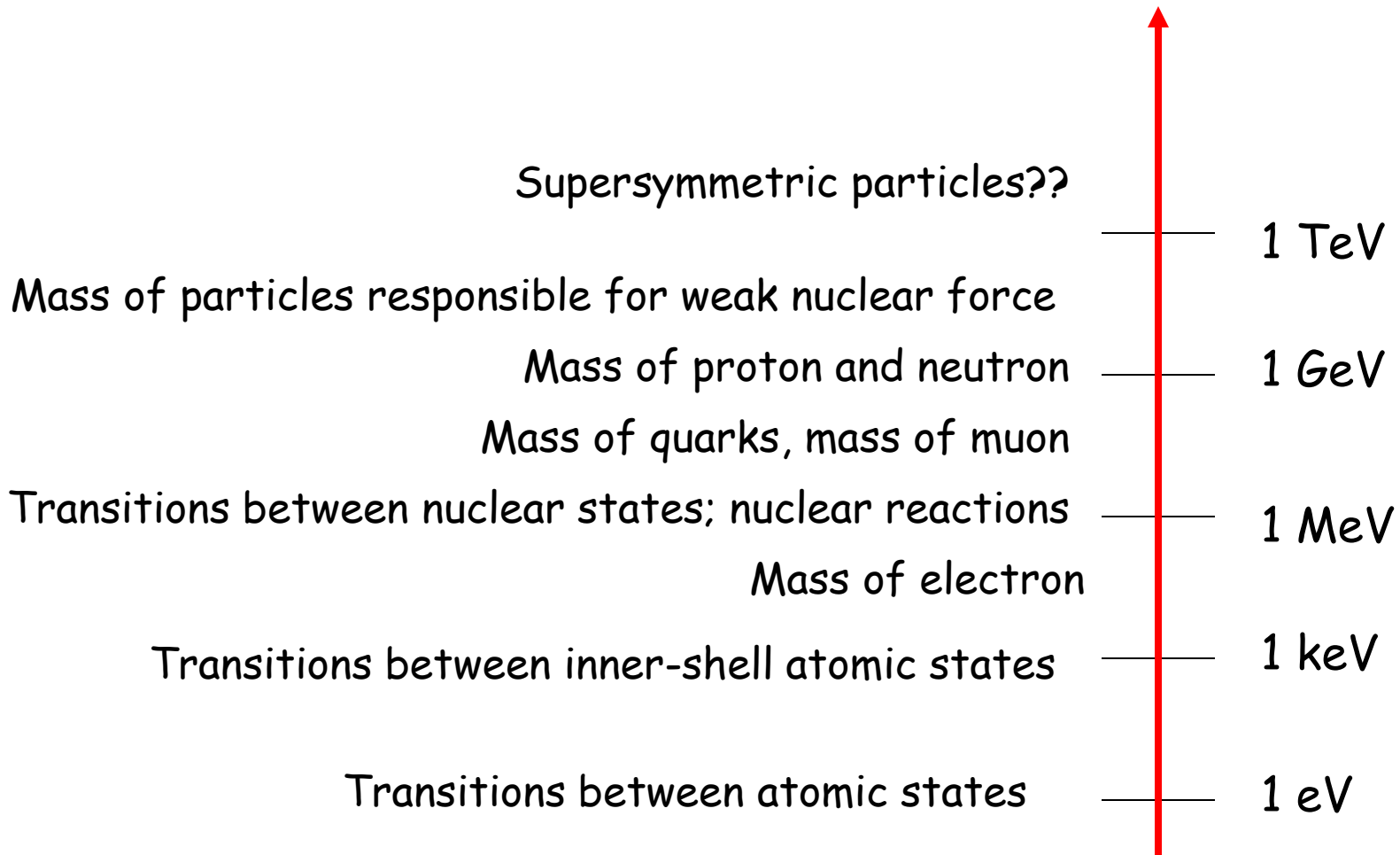



Secondary Particle Beams

- Beams of accelerated particles can be used to produce beams of secondary particles:
 - Photons (x-rays, gamma-rays, visible light) are generated from beams of electrons (light sources)
 - Neutrons are generated from beams of protons (spallation neutron sources)
- These secondary particle beams are in turn used to study materials and their properties



Timeline

- 1895: Roentgen discovers x-rays
- 1897: J.J. Thomson discovers the electron
- 1905: Einstein's theory of relativity, Einstein's theory of light quanta
- 1907: Schott develops first theory of synchrotron radiation
- 1911: Rutherford discovers atomic nucleus using alpha particles
- 1920: Greinacher builds first cascade generator of about 100 kV
- 1924: Ising proposes first concept for acceleration by repeated application of voltage kicks
- 1927: Wideroe makes first linear accelerator; accelerates Na and K ions
- 1928: Dirac predicts existence of antimatter (positrons)
- 1931: Van de Graaff builds first high-voltage generator
- 1932: Cockroft and Walton construct first "high-energy" accelerator, produce first artificially generated nuclear reaction: $p + \text{Li} \rightarrow 2 \text{He}$
- 1932: Lawrence and Livingston construct first cyclotron giving 1.2 MeV protons



Timeline

- 1932: positrons and neutrons are discovered
- 1941: Kerst and Serber build first betatron
- 1941: Touschek and Wideroe invent concept of a particle storage ring
- 1943: Oliphant invents concept of synchrotron
- 1947: First direct observation of synchrotron radiation at GE
- 1947: Alvarez builds first proton linear accelerator
- 1947: Ginzton builds first electron linear accelerator
- 1950-1952: Concept of strong-focusing is invented
- 1954: R.R. Wilson et. al. builds first strong-focusing synchrotron at Cornell
- 1956: Hartmann uses synchrotron radiation for first spectroscopy experiments
- 1960: First electron-positron collider: ADA at Frascati
- 1972: First proton-proton collider: ISR at CERN
- 1981: First proton-antiproton collider: SPS at CERN



Creation of new particles

- Einstein's famous equation: $E=mc^2$ puts mass and energy on an equal footing.
- An energetic particle has total relativistic energy $E = T + m_0c^2$,
- One particle colliding with its antimatter partner can annihilate and produces pairs of other particles. Example:

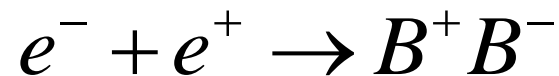

	Rest Mass Energy [MeV]	Kinetic Energy [MeV]
e^+, e^-	0.511	5290
B^+, B^-	5279	11.5



Types of particle accelerators

- A wide variety of particle accelerators are in use today. The types of machines are distinguished more by the velocity of particles that are accelerated than by the mass of particle accelerated.
- Accelerators for electrons generally “look” different from accelerators for protons or heavy ions.

Example:

- Compare velocities of particles generated at 100 keV kinetic energy:
 - Electrons: $v/c = 0.55$
 - Protons: $v/c = 0.015$
 - Au^{1+} : $v/c = 0.001$
- This has important implications for the type of acceleration scheme that is appropriate, as we will see throughout this course.



Proton and Electron Velocities vs. Kinetic Energy

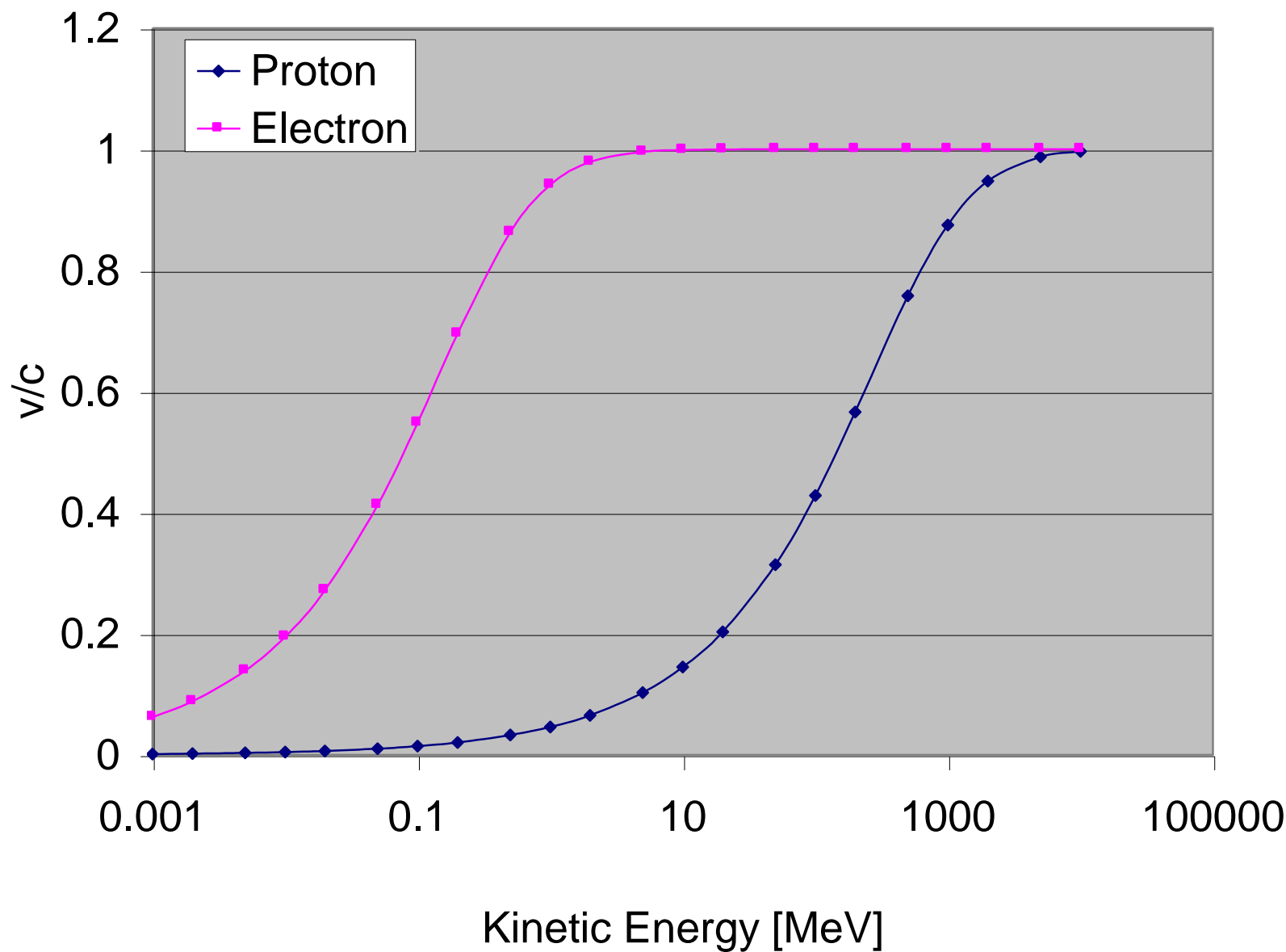



Potential-Drop Accelerators

- These accelerators use at static, DC, potential difference between two conductors to impart a kinetic energy

$$\Delta W = qV_0$$

- Earliest particle accelerators were the Cockcroft-Walton generator and the Van de Graaff generator
- Highest voltage achieved is 25 MV
- It is difficult to establish and maintain a static DC field of 20+ MV

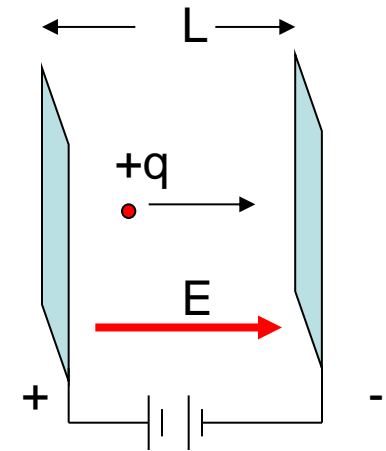

Van de Graff (tandem) generator

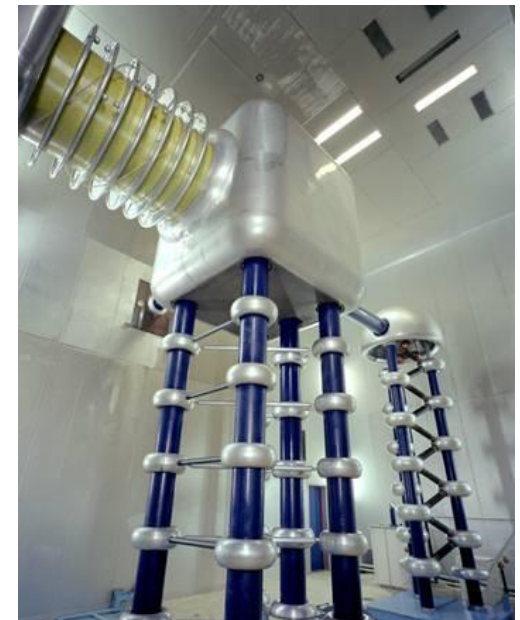

Cockroft-Walton generator



Acceleration by repeated application of time-varying accelerating fields

- Two approaches for accelerating with time-varying fields

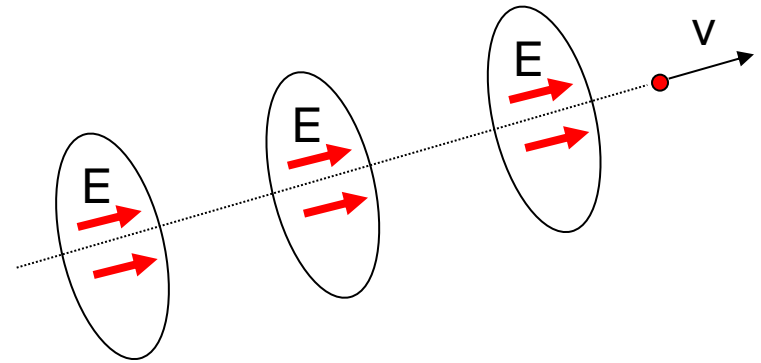
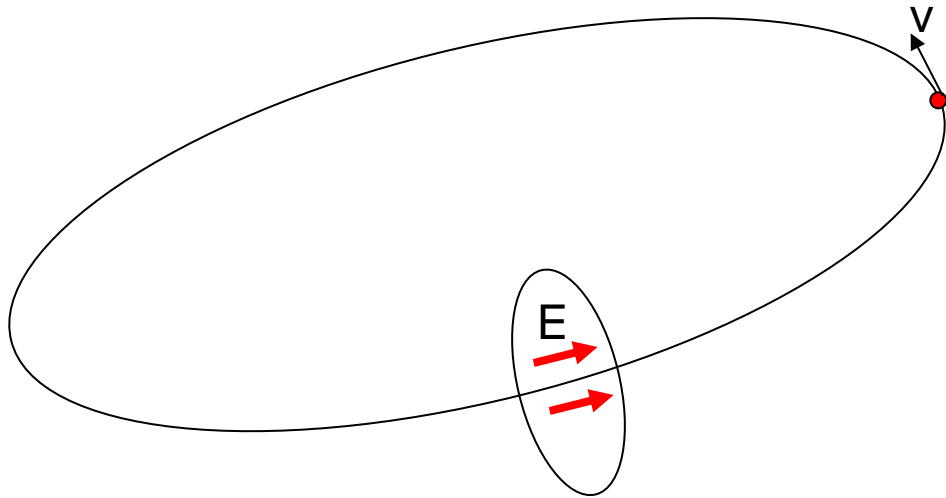

Circular Accelerators

Use one or a small number of Radio-frequency accelerating cavities and make use of repeated passage through them. This approach is realized in circular accelerators: Cyclotrons, synchrotrons and their variants

Linear Accelerators

Use many accelerating cavities through which the particle beam passes once:

These are linear accelerators



Acceleration by Repeated Application of Time-Varying Fields

- Ising and Wideroe suggested to repeatedly apply a much smaller voltage in a linear accelerator by using time-varying fields
- In this way, a high particle beam energy could be attained by repeatedly applying voltage “kicks”

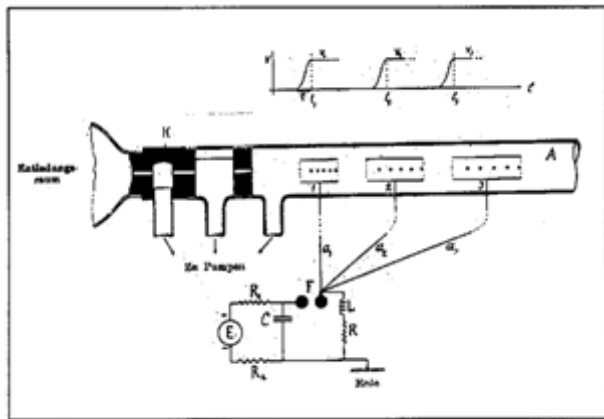

Ising's idea



R. Wideroe

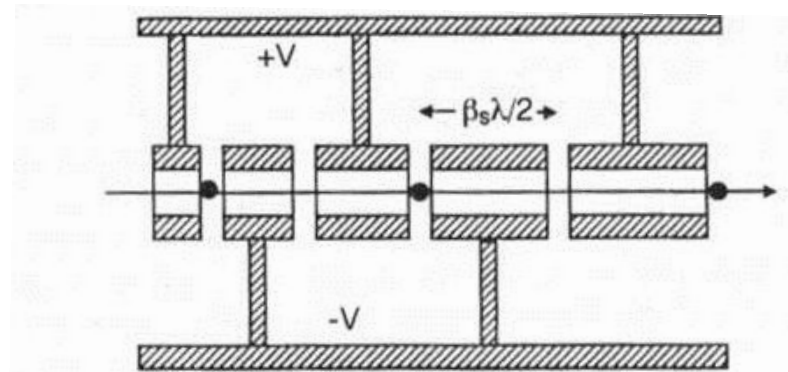
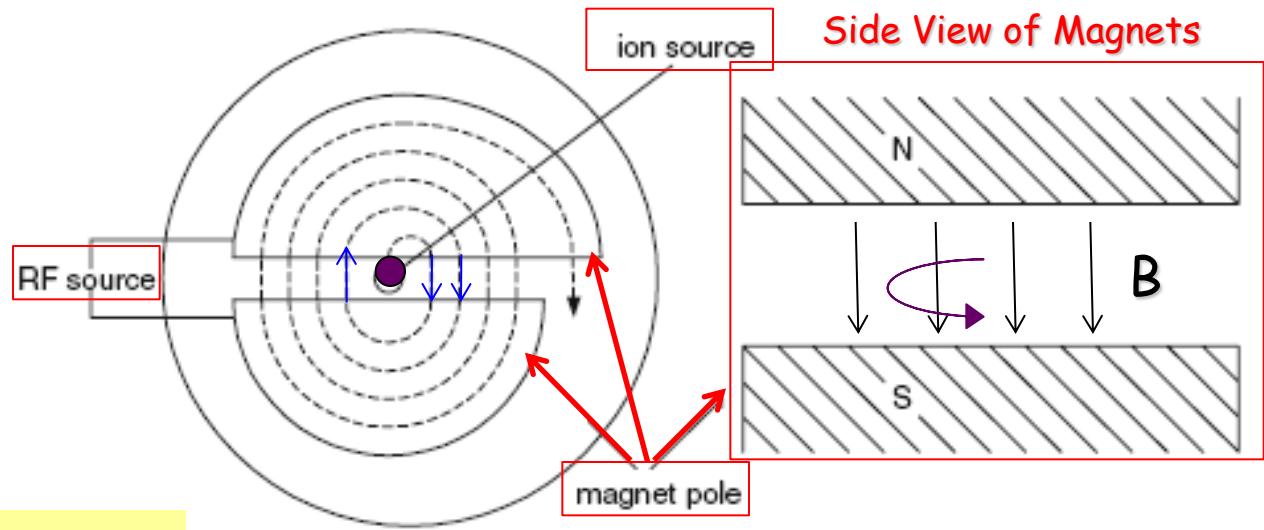

Figure 4.4 Wideroe or Sloan-Lawrence or interdigital structure.



Lawrence's Application of Wideroe's Idea: The Cyclotron (Protons)



E. O. Lawrence: Nobel Prize, 1939

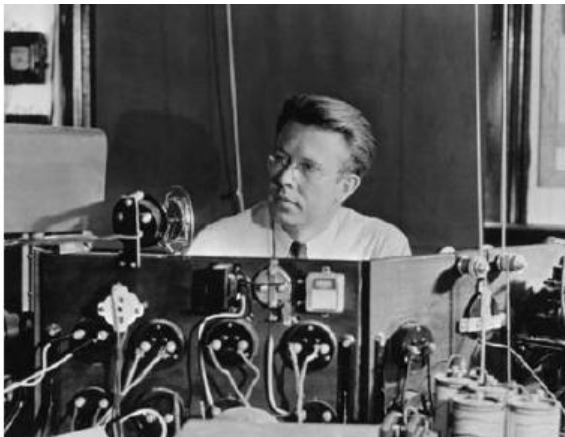

The first cyclotron
4.5" diameter
(1929).

Fig. 1.10. Ernest Lawrence at the controls of the 37 inch cyclotron in about 1938
(Reprinted with permission from LBL)

For comparison, cyclotrons operating today are up to 18 meters in diameter.



The Cyclotron: Different Points of View

The Cyclotron, as seen by...

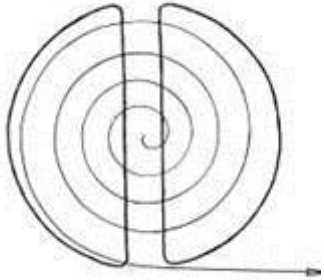

... the inventor

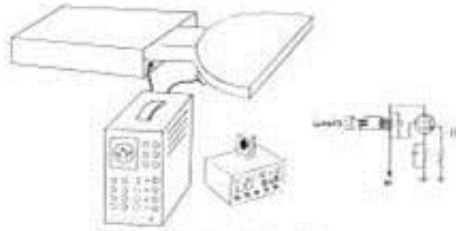

... the electrical engineer

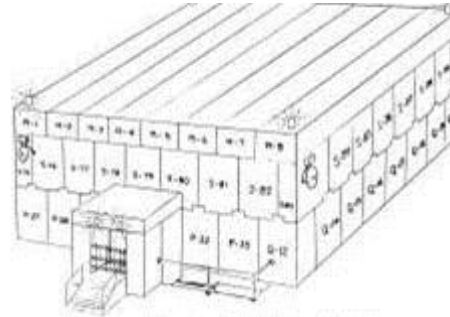

... the health physicist



... the experimental physicist



...the operator

From LBNL Image Library
Collection

By Dave Judd and Ronn MacKenzie

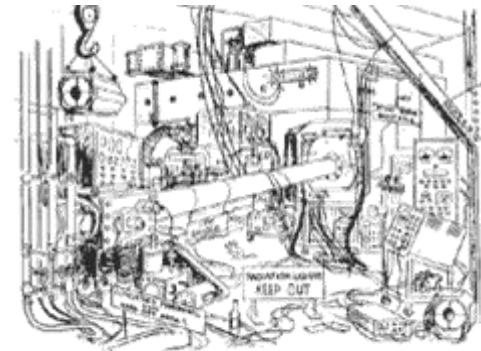

...the visitor

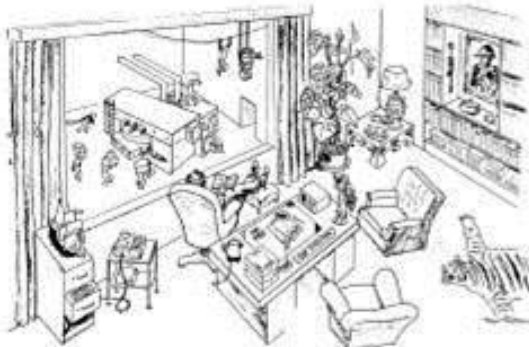

... the laboratory director

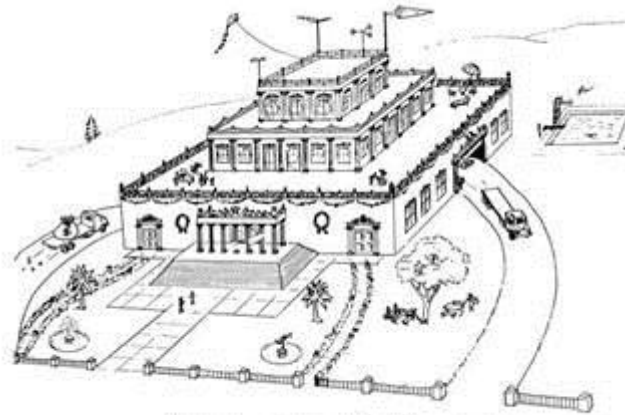

... the governmental funding agency

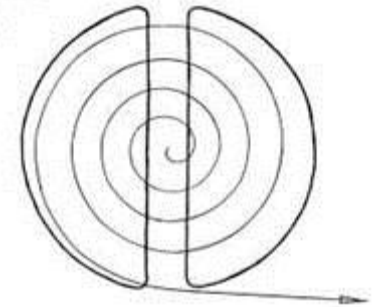

... the student



Cyclotron Principle for Protons

- Non-relativistic uniform circular motion is maintained via centripetal acceleration:

$$\frac{mv^2}{r} = qvB$$

- The radius is

$$r = \frac{mv}{qB}$$

- The revolution period and frequency are independent of particle velocity:

$$T = \frac{2\pi r}{v} = \frac{2\pi m}{qB}$$

$$\omega = \frac{2\pi}{T} = \frac{qB}{m}$$

- A particle in resonance with this time varying field will be accelerated. The particle is in **synchronism** with the time-varying field.
- Such cyclotrons can accelerate protons up to 20-30 MeV
- At high energies these equations break down because of relativistic effects. The frequency changes and the particle falls out of synchronism with the accelerating field.



Accounting for Frequency Change: The Synchro-Cyclotron

$$W_{rev} = \frac{qB}{m} \gg nf_{RF}$$

- Veksler and McMillan showed, independently of each other, that by **adjusting the frequency** of the applied voltage to the decreasing frequency of the rotating protons, it was possible to accelerate the protons to several hundred MeV.
- Whereas the cyclotron can accelerate a stream of particles, the synchro-cyclotron can only accelerate one 'bunch' of particles
- Alternatively, one could **vary the magnetic field** to keep the revolution frequency constant. This is an isochronous cyclotron.



The largest synchrocyclotron still in use is located in Gatchina outside St Petersburg and it accelerates protons to a **kinetic energy of 1,000 MeV**. The iron poles are 6 meters in diameter and the whole accelerator weighs 10,000 tons, a weight **comparable to that of the Eiffel Tower**.

The Synchrotron – Protons or Electrons

- In synchrotrons, the particles are accelerated along a closed, circular orbit. Both the accelerating field frequency and the magnetic field strength change with time as the particle is accelerated (frequency decreases and field increases).

The synchrotron concept was first proposed in 1943 by the Australian physicist Mark Oliphant.

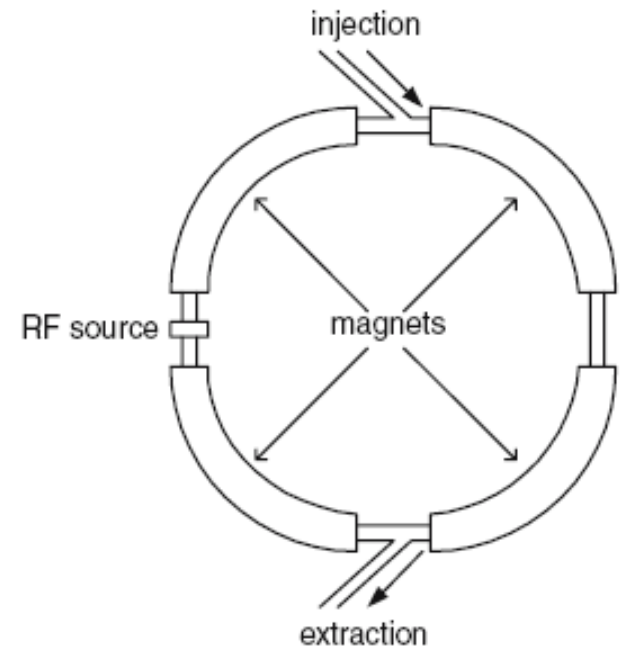

Fig. 1.12. Principle of a synchrotron



The Synchrotron

- The bending field changes with particle beam energy to maintain a constant radius:

$$\frac{1}{\rho[m]} = 0.3 \frac{B[T]}{\beta E[GeV]} = 0.3 \frac{B[T]}{cp[GeV]}$$

- So B ramps in proportion to the momentum. The revolution frequency also changes with momentum.
- The synchronicity condition, including now the relativistic term, is:

$$\omega = \frac{qB}{m\gamma}$$

- For an electron synchrotron, the injected beam is already relativistic, so only the magnetic field changes with beam energy
- For a proton synchrotron, the injected beam is not yet relativistic, so the RF accelerating frequency and the magnetic field both ramp with energy



Particle Beam Focusing

- In addition to accelerating particles, we also need some way of keeping the particles together in the transverse plane. Left to it's own devices, a bunch of particles will diffuse and get larger and larger.
- The solution: Magnetic focusing. Think about light optics – the farther the incoming light beam is from the center axis, the larger the focusing kick it receives:

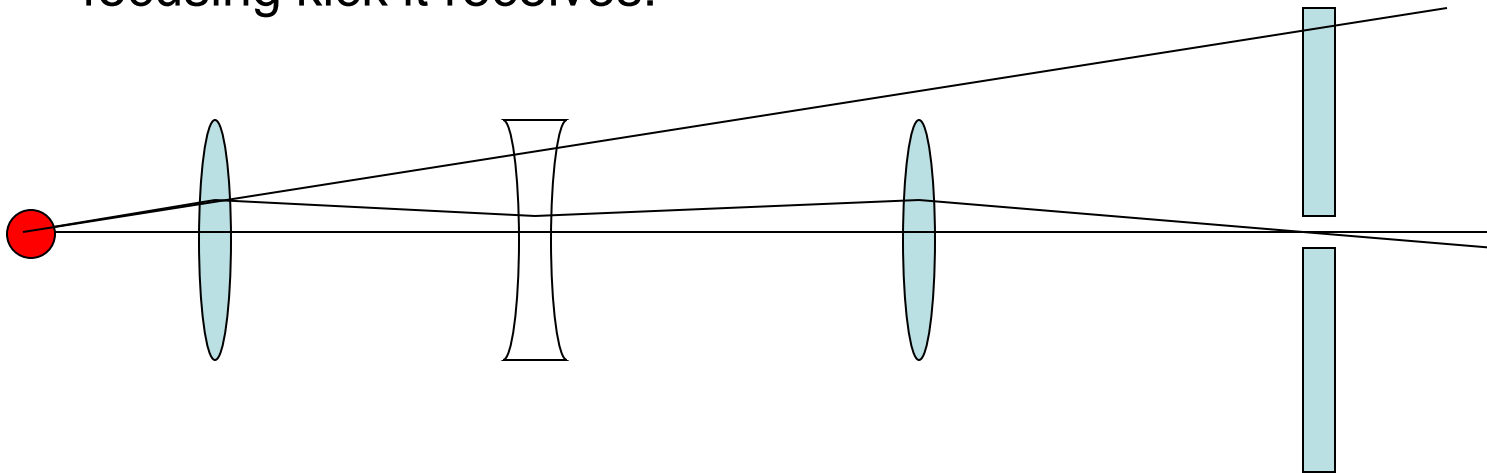

- This concept was first applied to particle accelerators by Courant, Livingston and Snyder
- It is known as “Strong Focusing” or “Alternating Gradient Focusing”
- “Optical” magnetic elements provide focusing (later....)



Strong-focusing Synchrotrons

- In earlier accelerators, the bending magnets were made to also focus the beam by a built-in field gradient.
- Thanks to strong focusing, the magnet apertures can be made smaller and therefore much less iron is needed than for a weak-focusing synchrotron of comparable energy.
- The first alternating-gradient synchrotron accelerated electrons to 1.5 GeV. It was built at Cornell University, Ithaca, N.Y. and was completed in 1954.
- Most modern applications use separate-function magnets, including sequences of dipole magnets (bending) and quadrupole magnets (focusing).



Christofilos



Courant



Livingston



Snyder

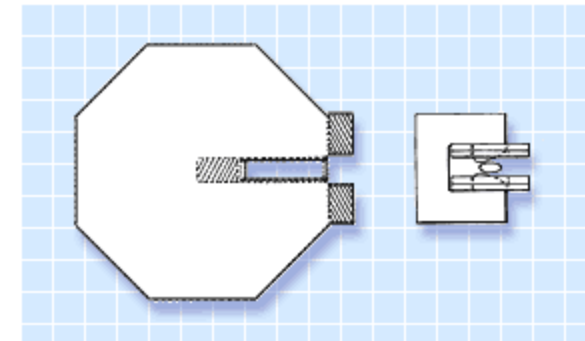

Size comparison between the Cosmotron's weak-focusing magnet (L) and the AGS alternating gradient focusing magnets



Strong-focusing Synchrotrons

Soon after the invention of the principle of alternating-gradient focusing, the construction of two nearly identical very large synchrotrons, which are still in operation, started at the European CERN laboratory in Geneva and the Brookhaven National Laboratory on Long Island. The CERN proton synchrotron (PS) started operation in 1959 and the Brookhaven Alternating Gradient Synchrotron (AGS) in 1960.

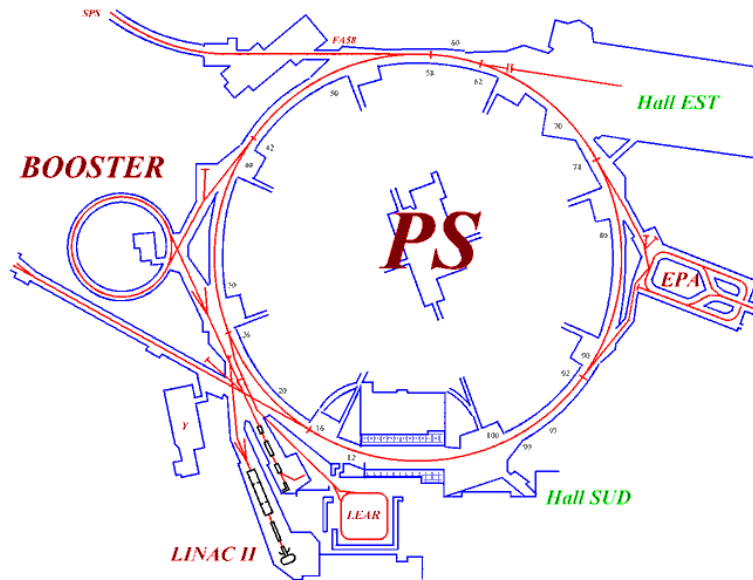

CERN PS



Brookhaven AGS



The Largest Synchrotron (and the Largest Collider)

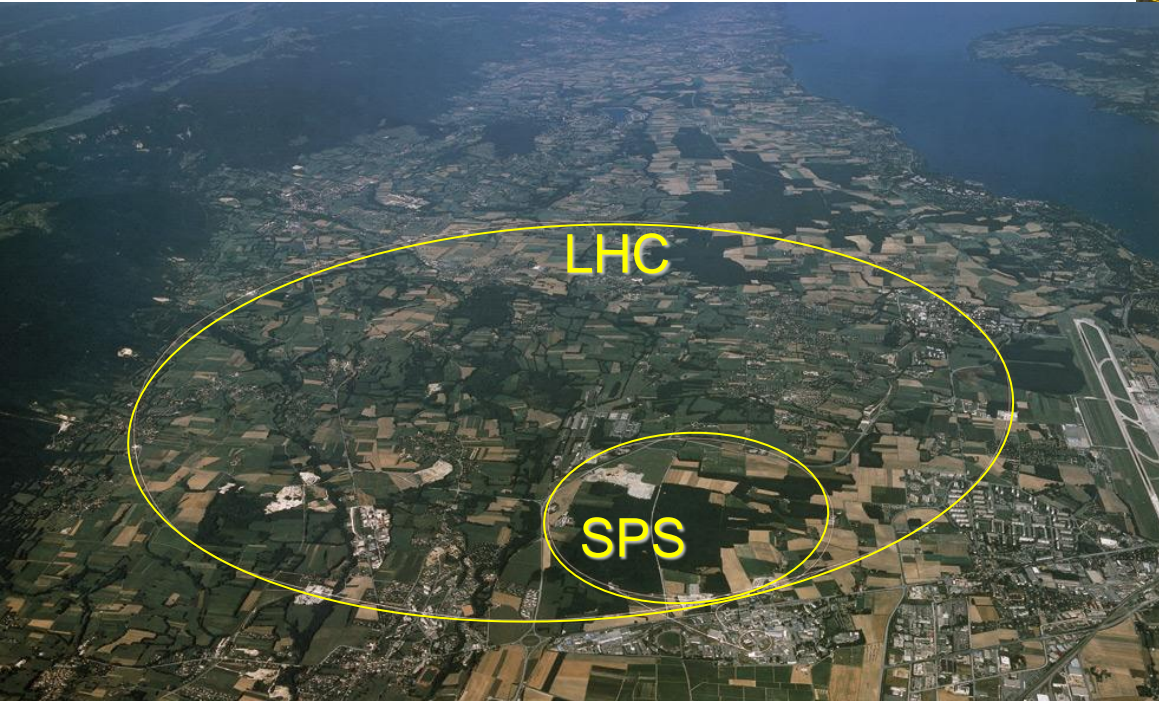

View inside the tunnel.

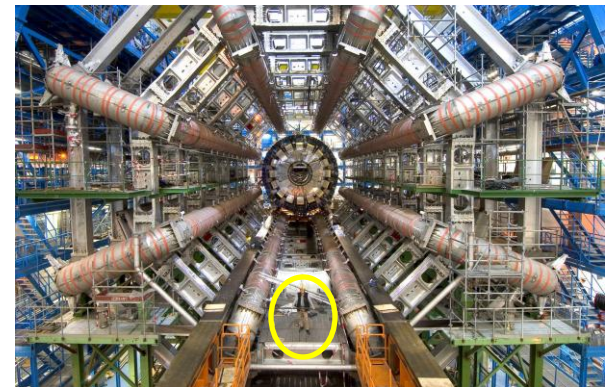

Photo of a detector.

Aerial view of the CERN laboratory situated between Geneva airport and the Jura mountains. The circles indicate the locations of the SPS (6.9km) and the Large Hadron Collider (LHC) which just became operational.

Photo: CERN



Linear Accelerators

- Whereas a circular accelerator can make use of one or a small number of RF accelerating cavities, a linear accelerator utilizes many (hundreds to thousands) of individual accelerating cells
- Again, accelerators for protons or ions “look” quite different from those that accelerate electrons, because electron beams are relativistic already at low energy
- Modern proton linear accelerators are based on the Alvarez Drift-Tube Linac. Alvarez was awarded the 1968 Nobel Prize in Physics for his contributions to elementary particle physics.

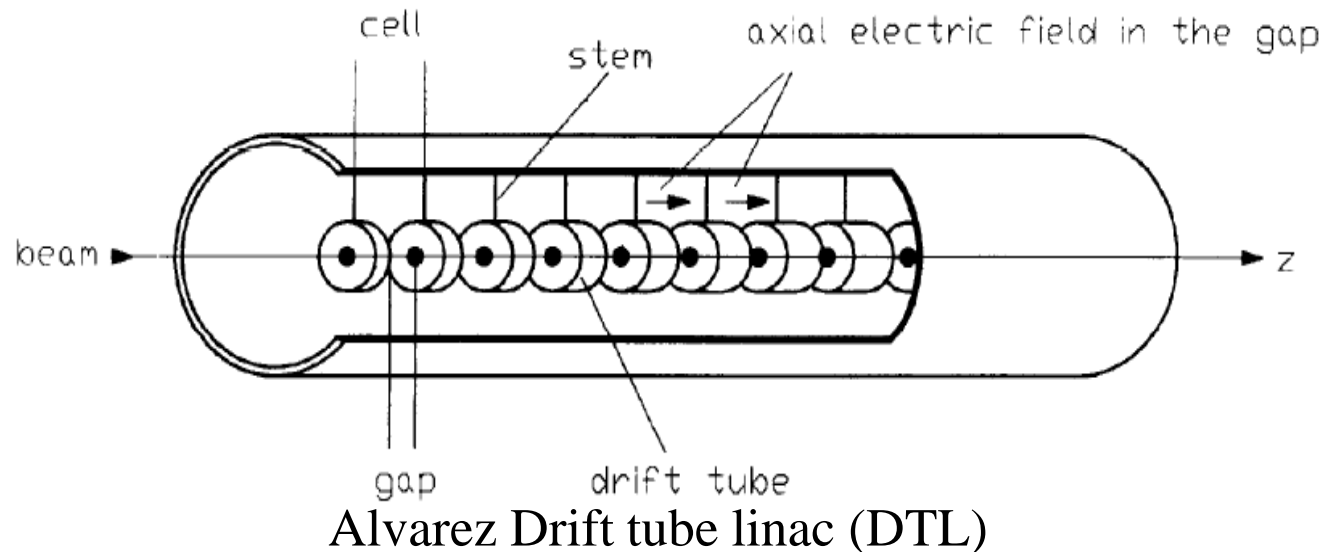



Linear Accelerators for Electrons (Disk Loaded Waveguide)

- Most electrons linacs utilize a structure known as the Disk-Loaded Waveguide
- Geometry looks somewhat different from that used for protons since electrons quickly become relativistic (more later....)

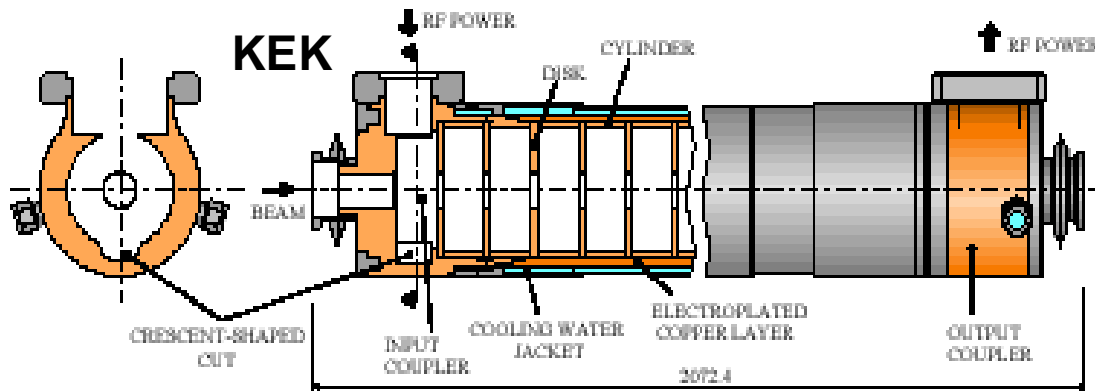
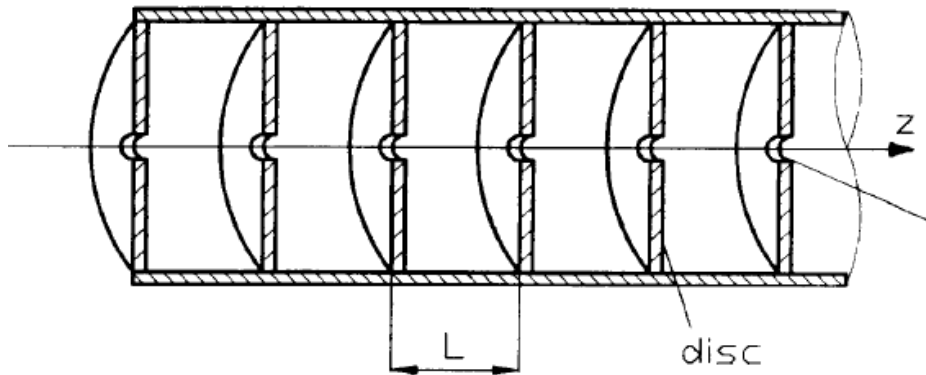



Example of an Accelerator Complex: CERN

- Most modern high energy accelerators are a series of linear accelerators and rings.
- Each piece is designed to accept and accelerate particles for up to a particular energy.
- Transferring a beam of particles between one piece and the next is one of the biggest challenges.

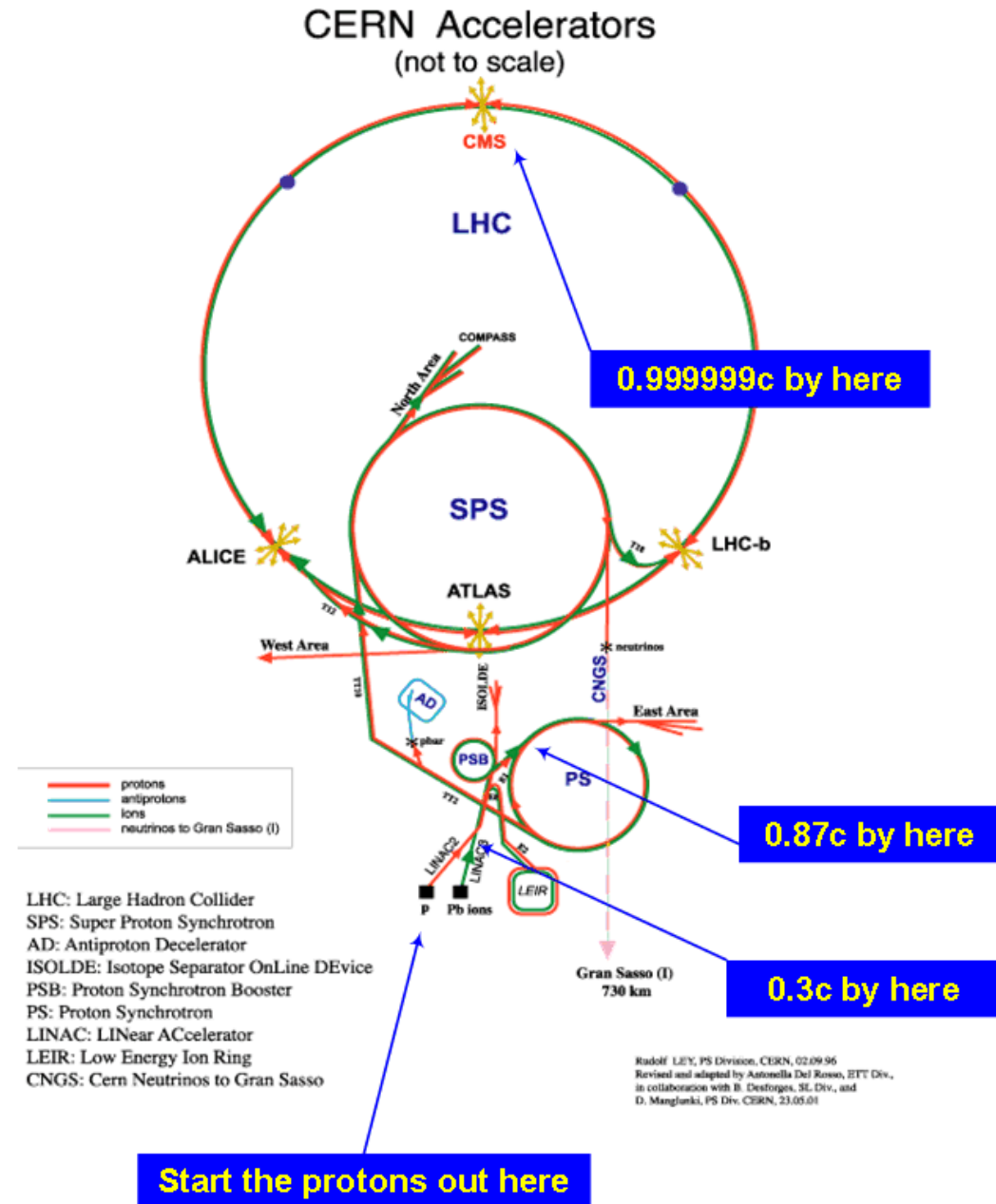



Energy Evolution

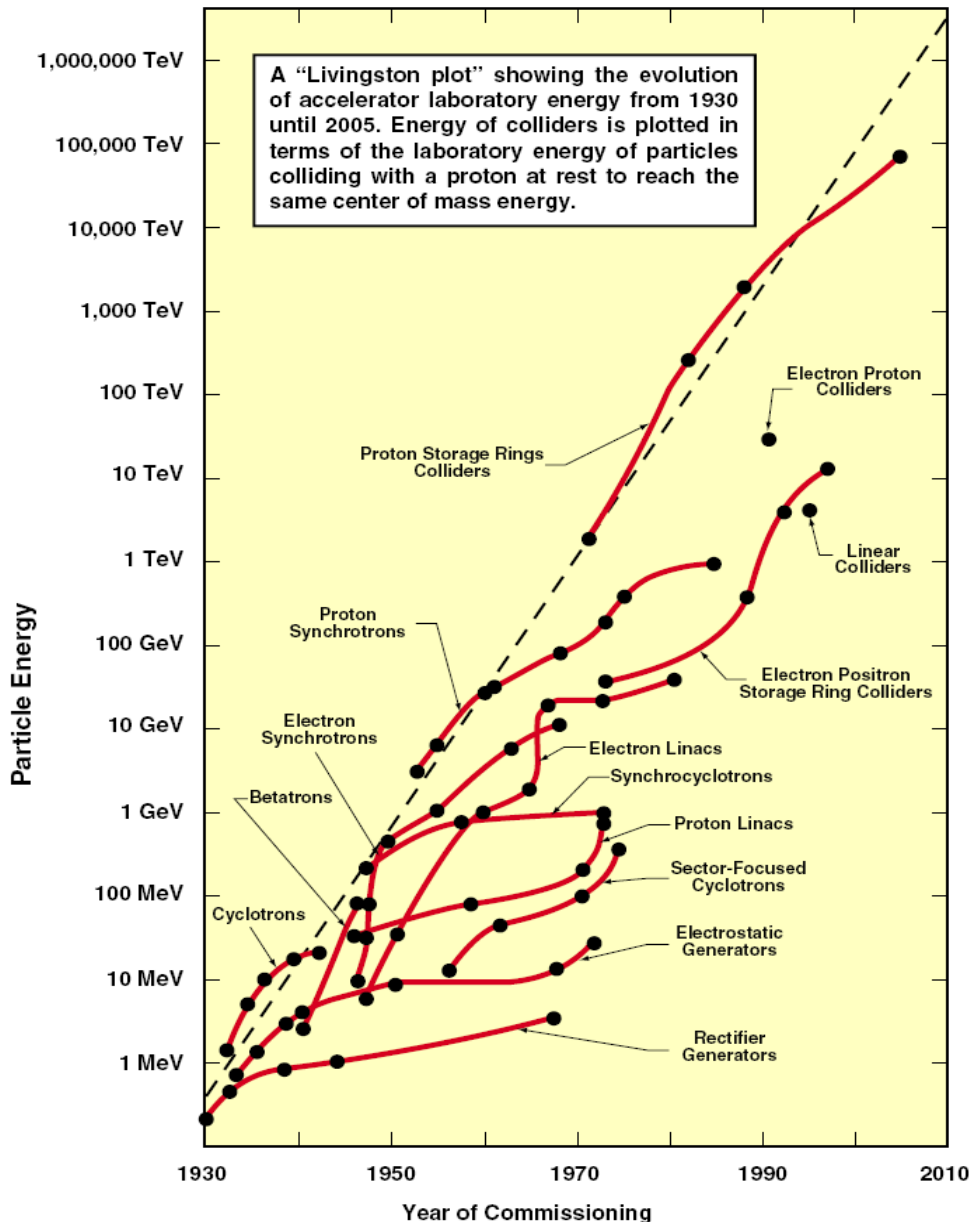

- Exponential growth of energy with time
- Increase of the energy by an order of magnitude every 6-10 years
- Each generation replaces previous one to get even higher energies
- The process continues...
- Energy is not the only interesting parameter
 - Intensity
 - Size of the beam



Discovery of Synchrotron Radiation

- 70 MeV electron synchrotron at General Electric, Schenectady, NY, 1947

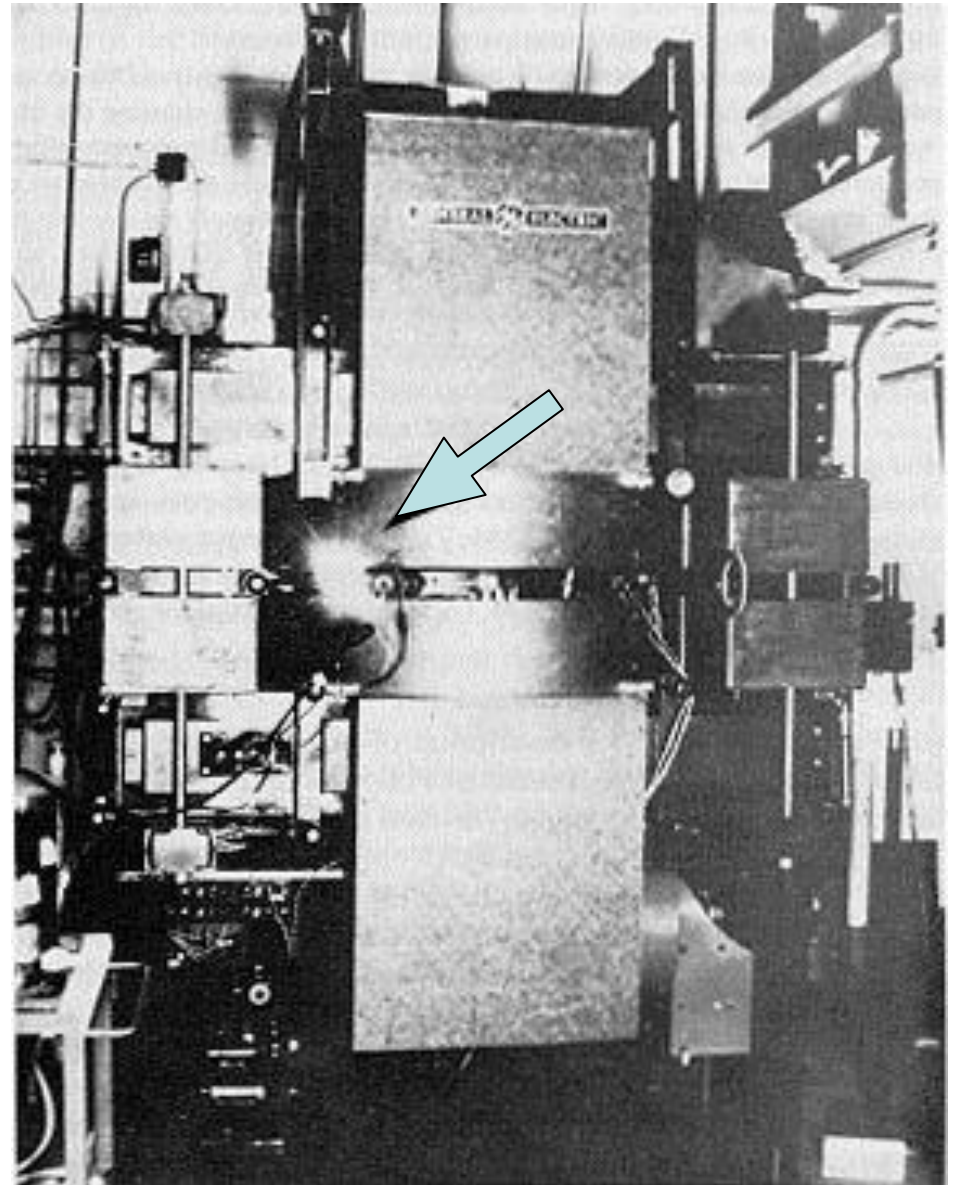



Accelerator –Based Light Sources



APS - USA

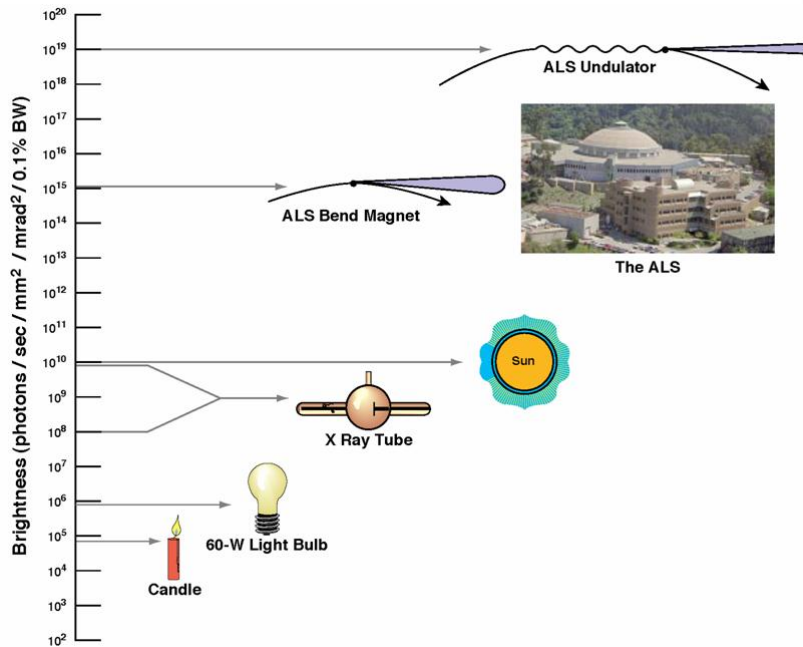
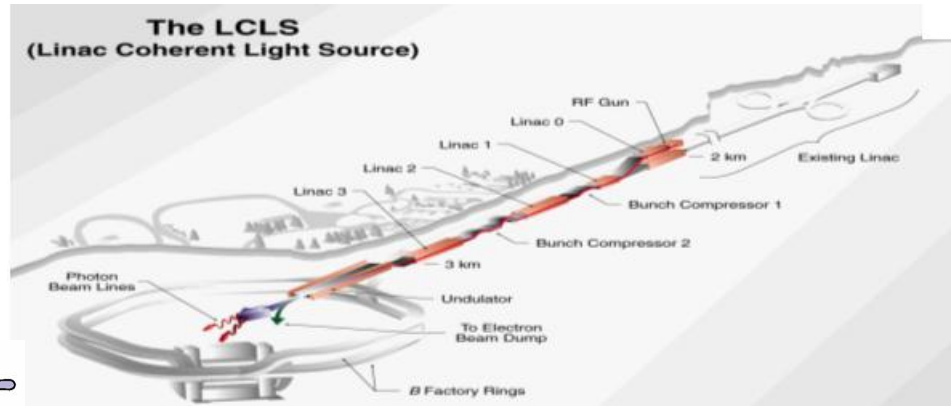

The ALS



ESRF- France

Modern synchrotron light sources are accelerators optimized for the production of synchrotron radiation.



Accelerator-Based Neutron Sources

- High-energy protons are used to generate neutrons from a heavy metal target via the spallation process
- Several labs, ISIS (RAL, UK), LANSCE (Los Alamos), SNS (ORNL), IPNS (Argonne), J-PARC (Japan) operate or are building these types of machines
- They use ~ 1 GeV protons accelerated by linacs or synchrotrons

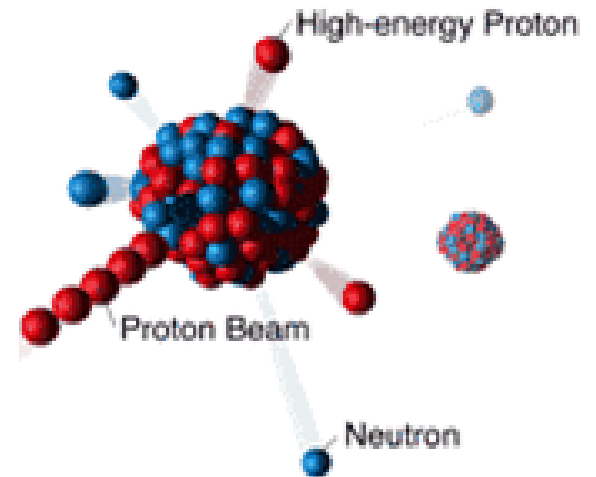

Spallation Neutron Source



Conclusion

- Accelerators have and continue to progress along several paths:
 - increasing beam energy
 - Increasing beam intensity
 - Increasing beam parameters, such as beam size (brightness) and particle collision frequency (luminosity)
- Accelerator science is a field that makes use of a broad range of physics and engineering



Acknowledgements

- **We would like to thank S. Henderson and B. Zwaska for sharing the slides that they used in previous USPAS courses.**