



Lecture 5

Magnetic Fields and Magnet Design

Sarah Cousineau, Jeff Holmes, Yan Zhang

USPAS

January, 2011



Definition of Beam Optics

Beam optics: The process of guiding a charged particle beam from A to B using magnets.

An array of magnets which accomplishes this is a *transport system*, or magnetic lattice.

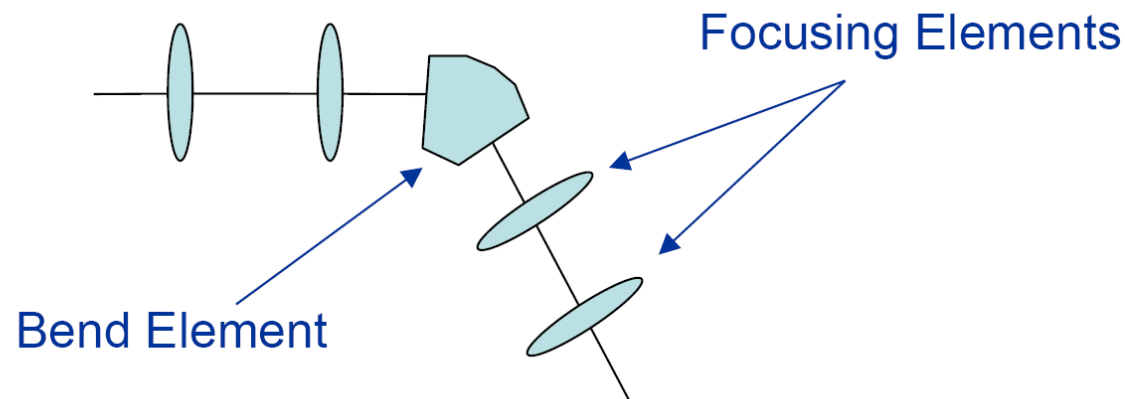

Recall the Lorentz Force on a particle:

$$F = ma = e/c(E + v \times B) = mv^2/\rho, \text{ where } m = \gamma m_0 \text{ (relativistic mass)}$$

In magnetic transport systems, typically we have $E=0$. So,

$$F = ma = e/c(v \times B) = m_0 \gamma v^2/\rho$$



Force on a Particle in a Magnetic Field

The simplest type of magnetic field is a constant field. A charged particle in a constant field executes a circular orbit, with radius ρ and frequency ω .

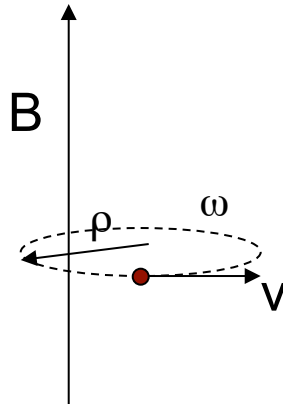

To find the direction of the force on the particle, use the right-hand-rule.

What would happen if the initial velocity had a component in the direction of the field?



Dipole Magnets

A **dipole magnet** gives us a constant field, B .

The field lines in a magnet run from North to South. The field shown at right is positive in the vertical direction.

Symbol convention:

- x - traveling into the page,
- \bullet - traveling out of the page.

In the field shown, for a positively charged particle traveling into the page, the force is to the right.

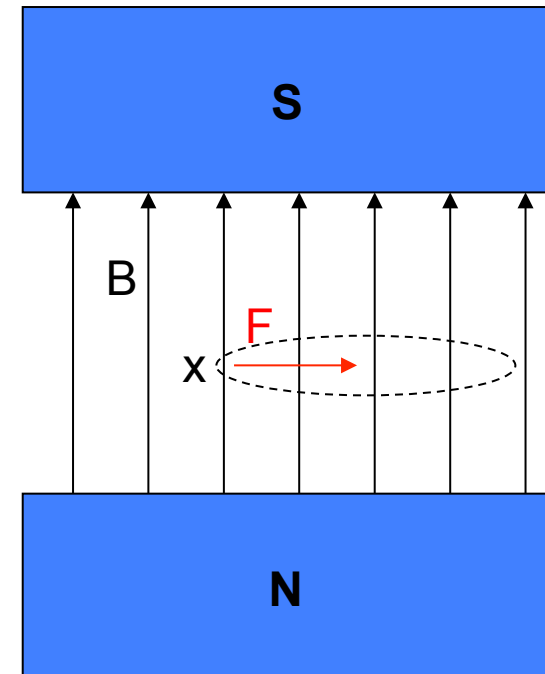

In an accelerator lattice, dipoles are used to *bend* the beam trajectory. The set of dipoles in a lattice defines the **reference trajectory**:

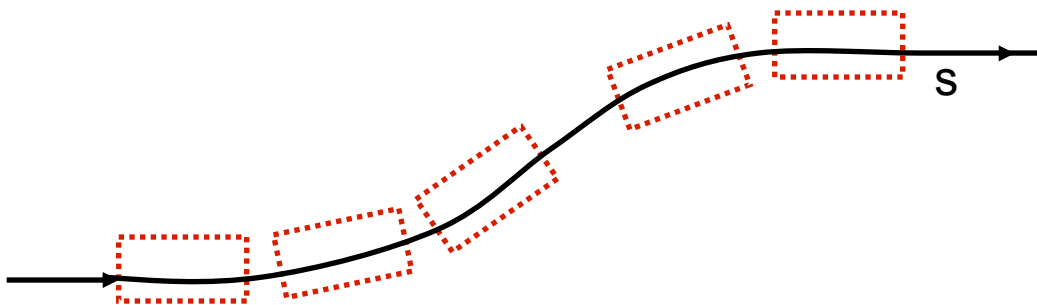



Field Equations for a Dipole

Let's consider the dipole field force in more detail. Using the Lorentz Force equation, we can derive the following useful relations:

For a particle of mass m , energy E , and momentum p , in a uniform field B :
(**Derivations**)

1) The bending radius of the motion of the particle in the dipole field, and the deflection angle are given by:

$$\frac{1}{\rho} (m^{-1}) = \frac{e}{p} B = \frac{ec}{\beta E} B = 2.998 \frac{B(T)}{\beta E(GeV)}$$

(Weidemann 2.4, 2.8)

$$\theta = \int \frac{ds}{\rho}$$

(Weidemann 2.9)

2) Re-arranging (1), we define the “magnetic rigidity” to be the required magnetic bending strength for given radius and energy:

$$B\rho(Tm) = \frac{p}{e} \quad (\text{Weidemann 2.6})$$



Generating a B Field from a Current

Recall that a current in a wire generates a magnetic field B which curls around the wire:

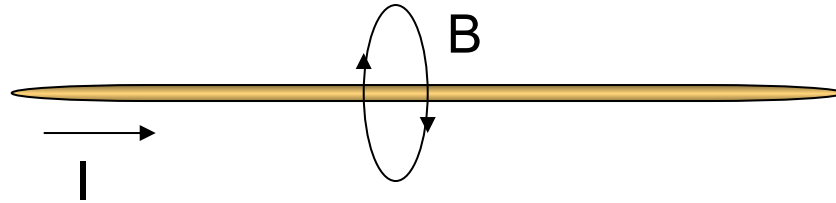

Or, by winding many turns on a coil we can create a strong uniform magnetic field.

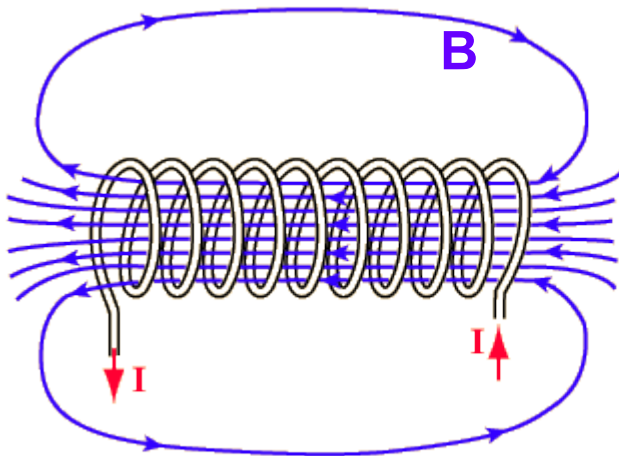

The field strength is given by one of Maxwell's equations:

$$\Delta \times \frac{B}{\mu_r} = J$$

$$\mu_r = \frac{\mu_{\text{material}}}{\mu_o}$$



The Dipole Current-to-Field Relationship

In an accelerator dipole magnet, we use current-carrying wires and metal cores of high μ to set up a strong dipole field:

N turns of current I generate a small $H=B/\mu$ in the metal.
Hence, the field, B , across the gap, G , is large.

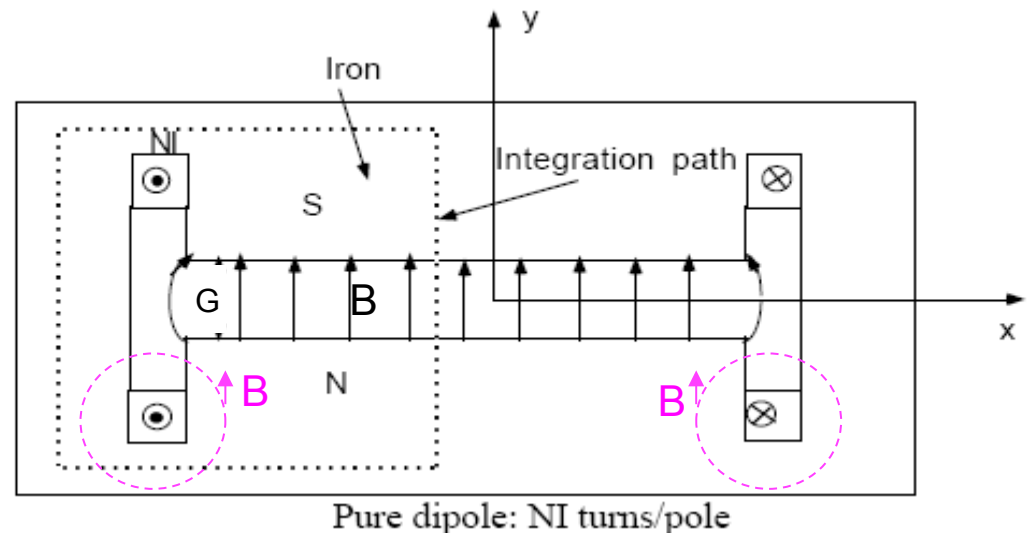

Using Maxwell's equation for B , we can derive the relationship between B in the gap, and I in the wires:

(**Derivation**)

$$I_{coil} = \frac{1}{\mu_0} B_{\perp} G$$

(Wiedemann 2.13)



Optical Analogy for Focusing

We have seen that a dipole produces a constant field that can be used to bend a beam.

Now we need something that can focus a beam. *Without focusing, a beam will naturally diverge.*

Consider the optical analogy of focusing a ray of light through a lens:

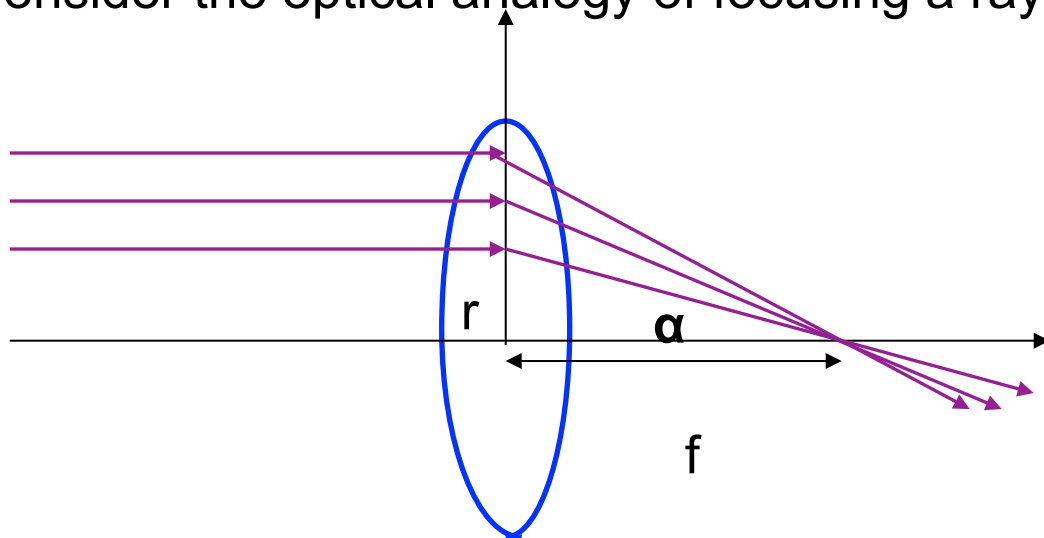

The rays come to a focus at the focal point, f . The focusing angle depends on the distance from center, r .

*The farther off axis, the stronger the focusing effect! The dependence is **linear** for small x .*

$$\tan \alpha = \frac{r}{f}$$

$$\alpha \approx \frac{r}{f}, \text{ for small } x$$



Focusing Particles with Magnets

Now consider a **magnetic lens**. This magnet has a field which increases in strength with distance from the axis.

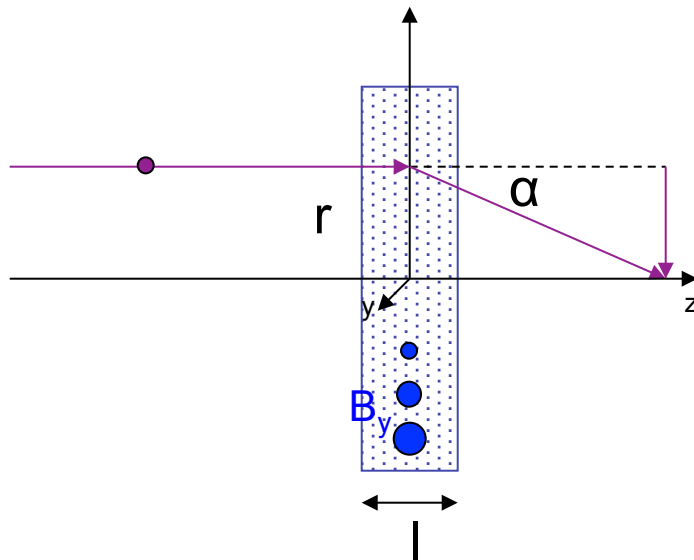

For a field which increases linearly with r , the resulting kick will also increase linearly with r .

We can solve for the focal length and focusing strength of this system:

(**Derivation**)

$$\alpha = \frac{ec}{\beta E} grL, \text{ where } g = \frac{dB_y}{dx}$$
$$k[\text{m}^{-2}] = \frac{1}{fL} = \frac{e}{pc} g = \frac{0.299 g[\text{T/m}]}{\beta E[\text{GeV}]} = \text{focusing strength}$$

(Wiedemann
2.15, 2.22, 2.23)



Quadrupole Magnets

A **quadrupole magnet** imparts a force proportional to distance from the center. This magnet has 4 poles:

Consider a positive particle traveling into the page (into the magnet field).

According to the right hand rule, the force on a particle on the right side of the magnet is to the right, and the force on a similar particle on left side is to the left.

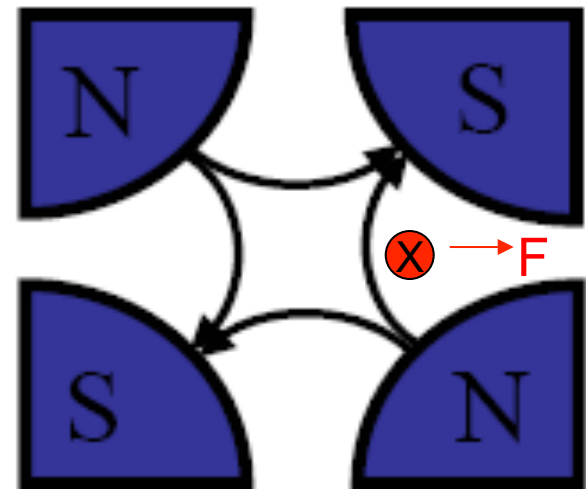

This magnet is horizontally defocusing. A distribution of particles in x would be defocused!

What about the vertical direction?

-> A quadrupole which defocuses in one plane focuses in the other.



Quadrupole Current-to-Field Equations

As with a dipole, in an accelerator we use current-carrying wires wrapped around metal cores to create a quadrupole magnet:

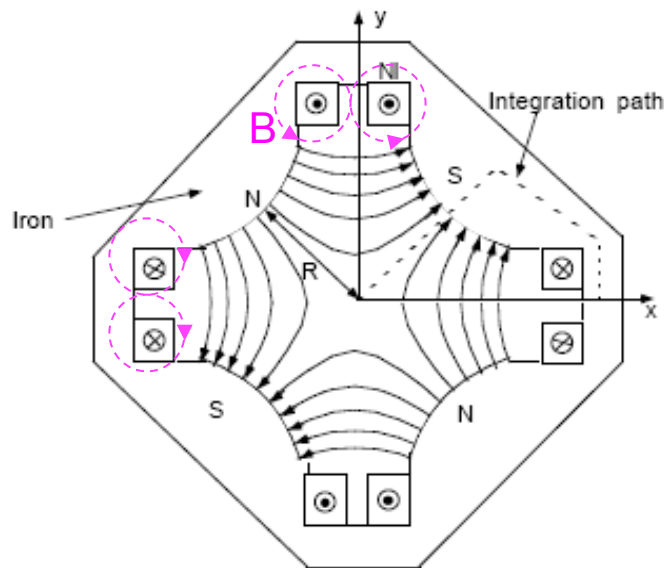

The field lines are denser near the edges of the magnet, meaning the field is stronger there.

The strength of B_y is a function of x , and visa-versa. The field at the center is zero!

Using Maxwell's equation for B , we can derive the relationship between B in the gap, and I in the wires:

(**Derivation**)

$$I_{coil} = \frac{1}{2\mu_o} gR^2$$

(Wiedemann 3.23)



Focusing Using Arrays of Quadrupoles

Quadrupoles focus in one plane while defocusing in the other. So, how can this be used to provide net focusing in an accelerator?

Consider again the optical analogy of two lenses, with focal lengths f_1 and f_2 , separated by a distance d :

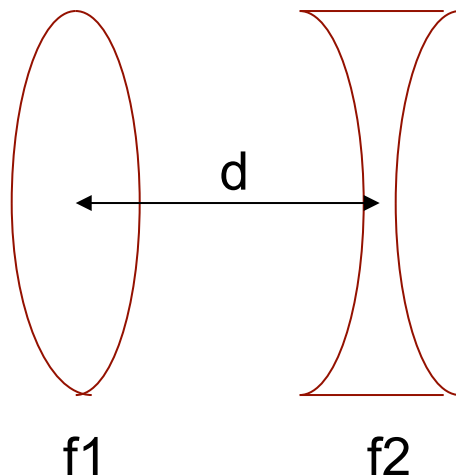

The combined f is:

$$\frac{1}{f_{combined}} = \frac{1}{f_1} + \frac{1}{f_2} - \frac{d}{f_1 f_2}$$

What if $f_1 = -f_2$?

The net effect is *focusing* (positive), $1/f = d/(f_1 f_2)$



More on Focusing Particles ...

The key is to alternate focusing and defocusing quadrupoles. This is called a FODO lattice (Focus-Drift-Defocus-Drift). :

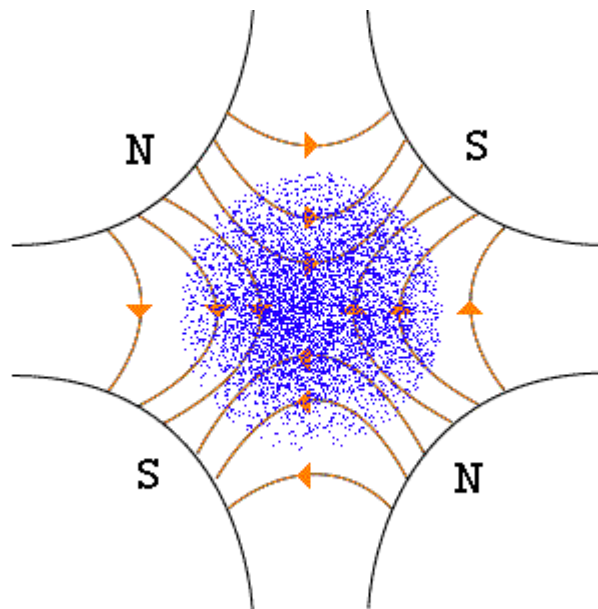
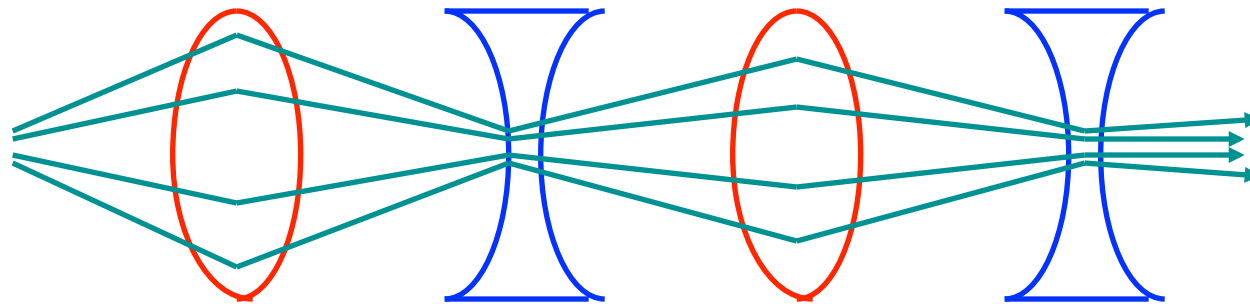



Other Types of Magnets

Many other types of magnets are used in an accelerator. For instance, gradient magnets are a type of “combined function” magnet which bend and focus simultaneously:

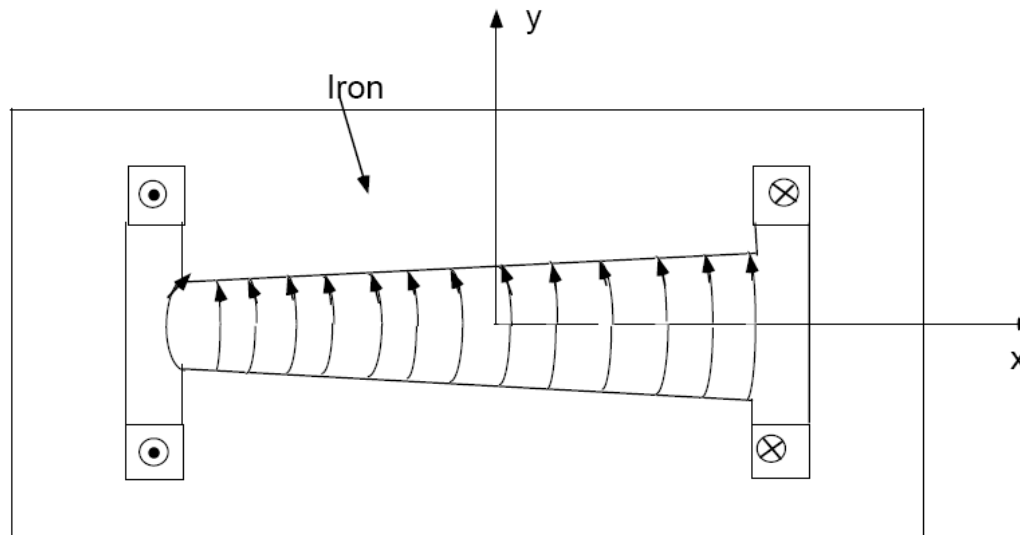

The B field in this magnet has both quadrupole and dipole components.

Another type of magnet is the solenoid, shown previously, which focuses in the radial direction.



Laplace's Equation

So far we have derived the B fields for two types of magnets (dipole and quadrupole). It would be very useful for us to have a general expression to represent the B field of *any* magnet.

Assumptions for a general accelerator magnet:

- 1) There is a material-free region for passage of particles.
- 2) The magnet is long enough that we can ignore components of B in the z direction, and treat only the (x,y) plane.
- 3) Fields are calculated in a current-free region ($\nabla \times B = 0$), so there is a scalar potential V such that $B = \nabla V$

Putting these together with $\nabla \cdot B = 0$, we arrive at Laplace's equation in free space:

$$\Delta V = 0$$



Properties of Solutions to Laplace's Equation

$$\Delta V = 0$$

$$\Delta V = \frac{d^2V}{dx^2} + \frac{d^2V}{dy^2} = 0 \quad (2D \text{ Cartesian})$$

$$\Delta V = \frac{d^2V}{dr^2} + \frac{1}{r} \frac{dV}{dr} + \frac{1}{r^2} \frac{d^2V}{d\varphi^2} = 0 \quad (2D \text{ Cylindrical})$$

What does a solution to Laplace's equation provide?

- 1) Any electromagnetic potential, V , which satisfies Laplace's equation can be visualized using a set of equipotential lines (in 2D) or equipotential surfaces (in 3D).
- 2) The B field, and thus the force on a particle, can easily be derived by differentiating V :
$$B = -\nabla V_B(x, y)$$
- 3) This is mathematically equivalent to the problem of electrostatics for E fields in charge-free regions.



Solution to Laplace's Equation

If we adopt a cylindrical coordinate system (r, ϕ, z) for the solution, V , then we can guess a solution for the potential in the form of a Taylor expansion:

Consider features of the magnets we have seen so far (dipole and quadrupole):

- 1) The dependence of field on position increases with magnet order (Dipole is const; Quadrupole goes as r). So B goes as r^n .
- 2) The angular location of poles decreases with magnet order (Dipole: 90; Quadrupole: 45). So B goes as $n\phi$.
- 3) The factor cp/e always shows up as a coefficient.

A general solution which meets these requirements:

$$V(r, \phi, z) = \frac{-p}{e} \sum_{n>0} \frac{r^n}{n!} A_n(z) e^{in\phi}$$

A_n are coefficients to be found.

(Wiedemann 3.3)



The Solution in Cartesian Coordinates

In practice, it will be more convenient to rewrite the solution in Cartesian coordinates, and to separate the real and imaginary pieces.

$$\begin{aligned}\text{Re}[V_n(x,y)] &= \frac{-p}{e} \sum_{m=0}^{n/2} A_{n-2m+1,2m} \frac{x^{n-2m}}{(n-2m)!} \frac{y^{2m}}{(2m)!} \\ \text{Im}[V_n(x,y)] &= \frac{-p}{e} \sum_{m=1}^{(n+1)/2} A_{n-2m+1,2m-1} \frac{x^{n-2m+1}}{(n-2m+1)!} \frac{y^{2m-1}}{(2m-1)!}\end{aligned}$$

Skew n-pole

Normal n-pole

(Wiedemann 3.28)

The real and imaginary pieces correspond to different physical orientations of the magnets – “skew” (real) and “normal” (imaginary). We are usually more interested in the “normal” magnets, because they decouple the linear motion in x and y.

(**Examples**)



Equipotential Lines for Multipoles

Recall that a solution to Laplace's equation gives a set of equipotential lines in the x - y plane. Some examples for "normal" magnets:

(**Derivations**)

Case $n=1$:

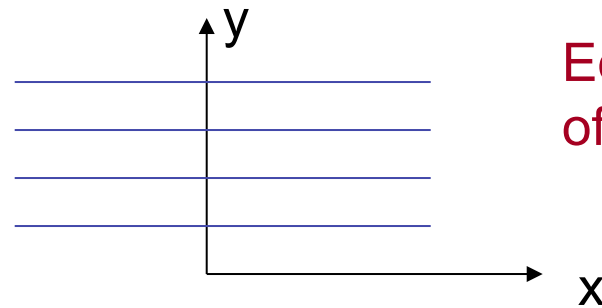

Equipotential lines
of constant y .

Case $n=2$:

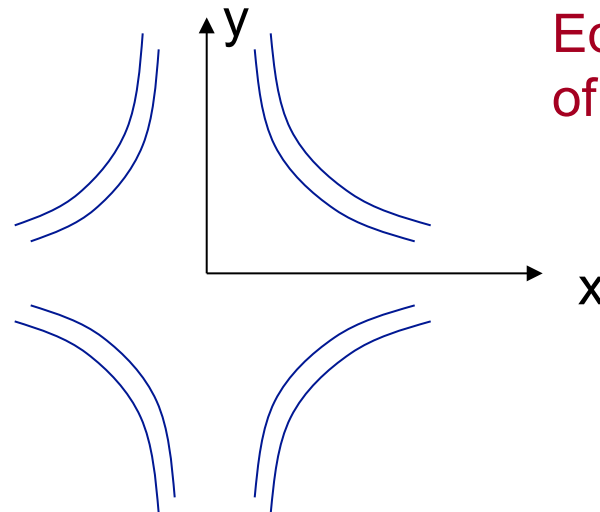

Equipotential lines
of constant xy .



Example: The Dipole Field

Example: Expand the potential for the $n=1$ case, and then find the field from the potential.

(**Derivations**)

$$V_1 = \frac{-p}{e} A_{01} y$$
$$B_1 = -\nabla V_1 = \frac{p}{e} A_{01} \hat{y},$$
$$A_{01} = \kappa = \frac{1}{\rho}$$

We find that $n=1$ gives a dipole field. The coefficient A_1 - B_1 is the dipole strength found earlier ($\kappa=1/\rho$). Note that for the normal case, only the vertical field (horizontal bending) is present.



Example: The Quadrupole Field

Another Example: Now expand the $n=2$ case:

(**Derivations**)

$$V_2 = \frac{-p}{e} A_{11} xy$$
$$B_x = -\frac{dV_2}{dx} = \frac{p}{e} A_{11} y; \quad B_y = -\frac{dV_2}{dy} = \frac{p}{e} A_{11} x$$
$$A_{11} = \frac{e}{p} \frac{dB_y}{dx} = k$$

These are the equations for a normal quadrupole, which we derived earlier. We can associate the coefficient A_2 - B_2 with the quadrupole strength, k .



Normal (Upright) Magnetic Fields

Lowest the orders for normal B field from expansion.
(For more, see Tables 3.3 and 3.4, Weidemann.)

$$\text{Dipole: } \frac{e}{p} B_x = 0 ; \frac{e}{p} B_y = \kappa_x$$

$$\text{Quadrupole: } \frac{e}{p} B_x = ky ; \frac{e}{p} B_y = \kappa_y x$$

$$\text{Sextupole: } \frac{e}{p} B_x = mxy ; \frac{e}{p} B_y = \frac{1}{2} m(x^2 - y^2)$$

A general expression for the normal “strength parameters”, (κ , k , m , etc...)

$$s_n = \frac{e}{p} \frac{\partial^{n-1} B_y}{\partial x^{n-1}} \Bigg|_{\substack{x=0 \\ y=0}}$$

$$s_n = \frac{0.2999}{\beta E} \frac{\partial^{n-1} B_y}{\partial x^{n-1}} \Bigg|_{\substack{x=0 \\ y=0}}$$

(Weidemann 3.32, 3.33)



Other n-Pole Magnets

The general equation for B allows us to write the field for any n-pole magnet. Examples of upright magnets:

n=1: Dipole

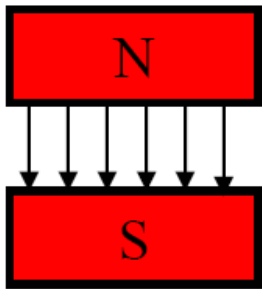

180° between poles

n=2: Quadrupole

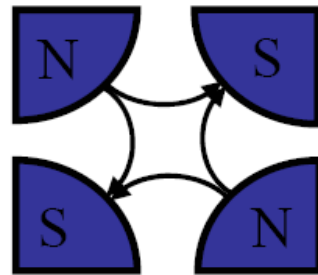

90° between poles

n=3: Sextupole

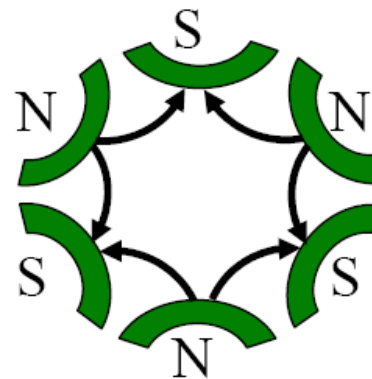

60° between poles

n=4: Octupole

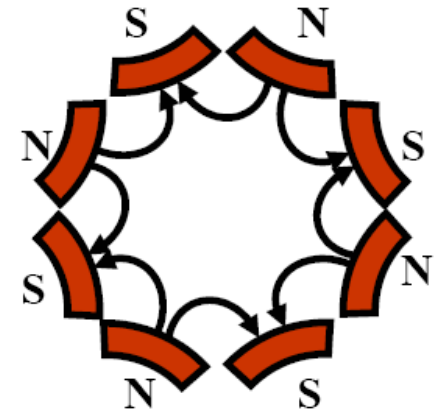

45° between poles

- In general, poles are $360^\circ/2n$ apart.
- The skew version of the magnet is obtained by rotating the upright magnet by $180^\circ/2n$.



n-Pole Uses

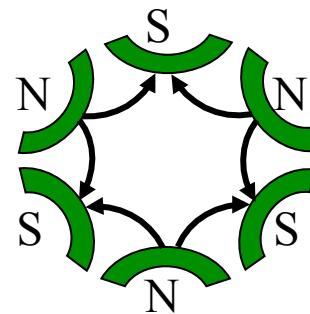
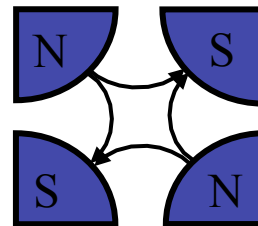
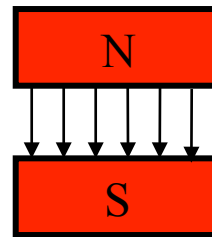
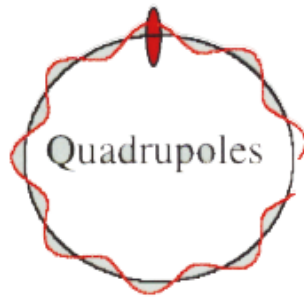
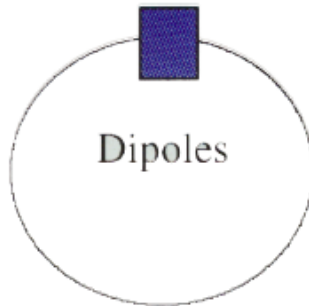

Bending (following reference trajectory)

Focusing the beam

“Chromatic compensation”



Magnet examples

Dipole

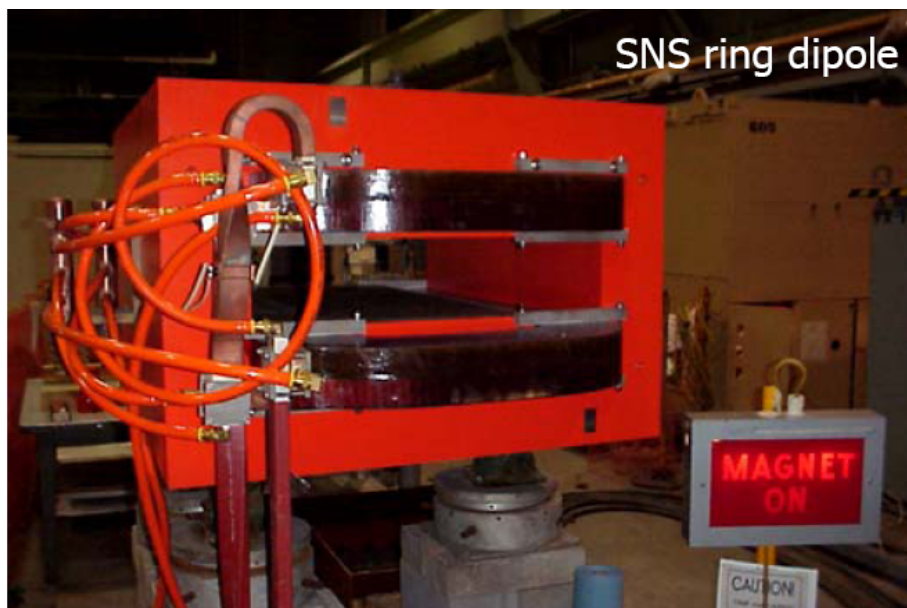

Quadrupole

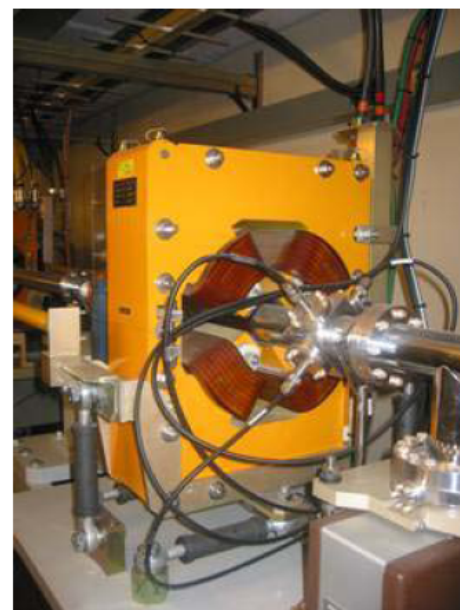

Sextupole

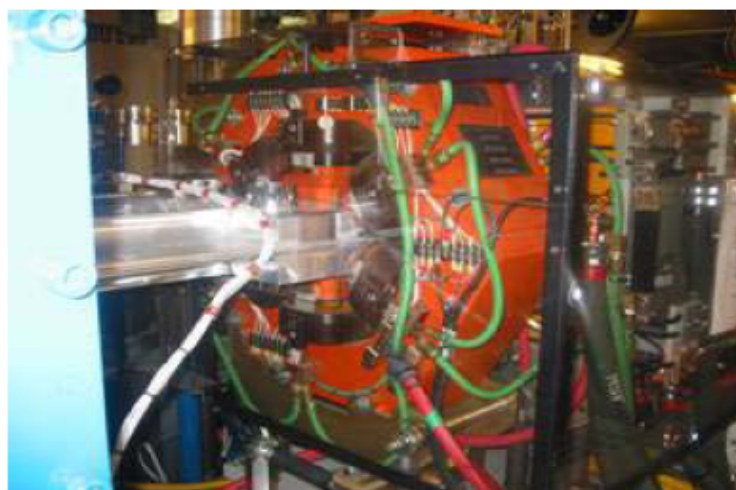



Realistic Magnetic Fields

In a “separated function” accelerator lattice, the magnets are designed to fulfill specific duties: Dipoles bend the beam, quadrupoles focus the beam, etc.

However, there is no such thing as a perfect n -pole magnet! All magnets have at least small contributions from other multipoles besides the main multipole. Generally, we require that the main multipole be much stronger than the other multipoles.

In terms of the Taylor series expansion for B , we require the fields generated by the desired $A_n \pm B_n$ to be much larger (several orders of magnitude) than fields generated by unwanted $A_{n'} \pm B_{n'}$.



Magnet Design – Pole Tip Geometry

How do we design a real magnet for a specific multipole component?

As seen earlier, our solution to Laplace's equation, V , gives us the equipotential lines for any particular multipole. Since $B = \nabla V$, the field is perpendicular to the equipotential surfaces. Because B is also perpendicular to the surface of a ferromagnetic material, such as iron, the surface is an equipotential surface. Therefore, we design the ferromagnetic “pole tip” to match the equipotential surface of the desired multipole.

The equation for the equipotential surface becomes the equation for the pole tip geometry.

(**Examples** - Dipole and Quadrupole)

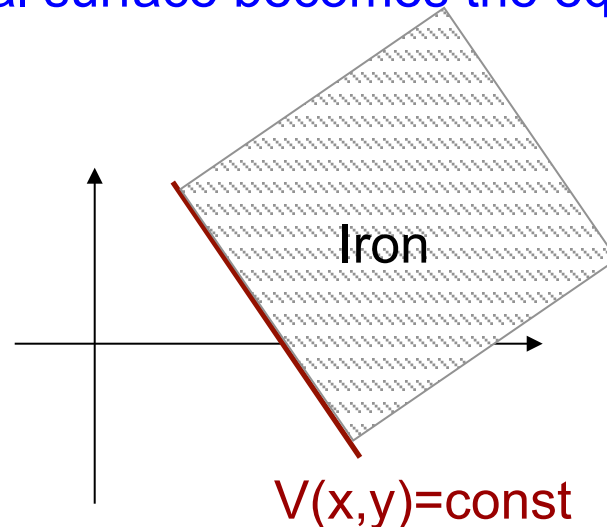



B-Fields at the Pole Tips

Now we need to add a B field to the material.

Below saturation of iron or similar material, the field lines on the vacuum side are always perpendicular to the pole tip surface:

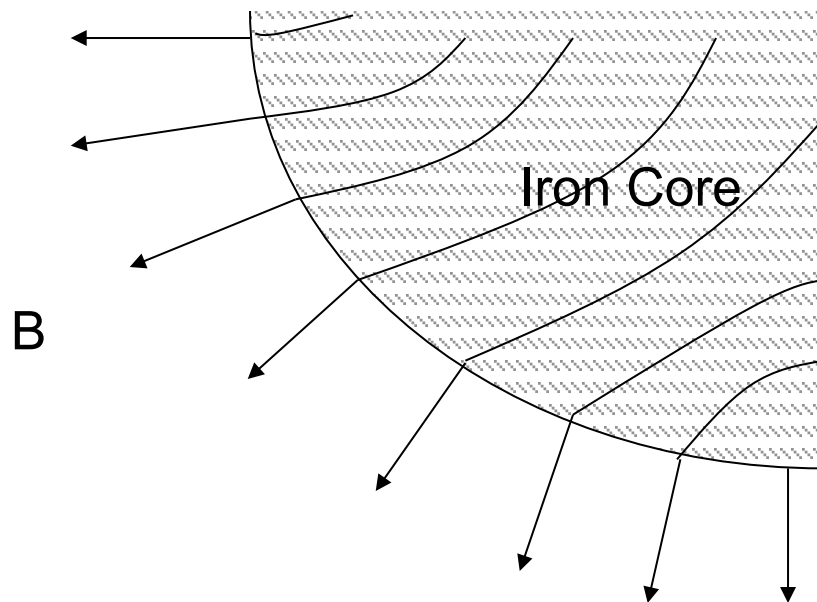

Magnetic lines may have both \parallel and \perp path inside the material, but outside, only the field \perp to the surface survives. To get as strong of a field in the gap as possible, we should try to make the \perp piece inside as large as possible.

Below saturation, we can add the B field any way we want inside the material. By setting the pole tip geometry to the magnetic equipotential for a multipole, we get B fields of the desired multipoles.



Saturation of Magnetic Materials

In a non-saturated field, the relationship between field strength, B , and driving current, I , is linear. Above saturation, an increase in current does not generate a corresponding increase in field:

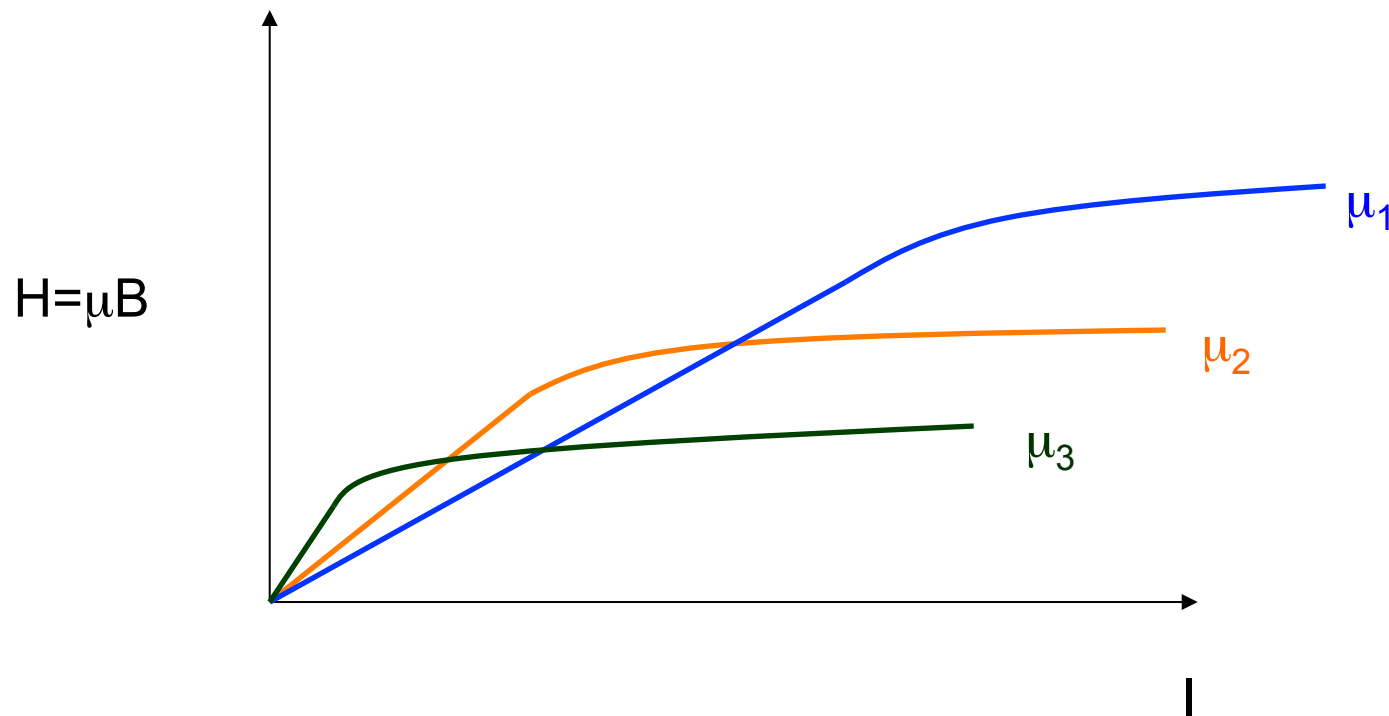

Different materials saturate at different levels.



Hysteresis and Magnet Cycling

An external B-field, created by a current I , creates a B-field in iron by aligning tiny internal dipoles (electron spins) in the material.

However, if the current and external field are dropped to zero, the material remains partially magnetized. *This gives rise to “hysteresis” and the need for magnet cycling.*

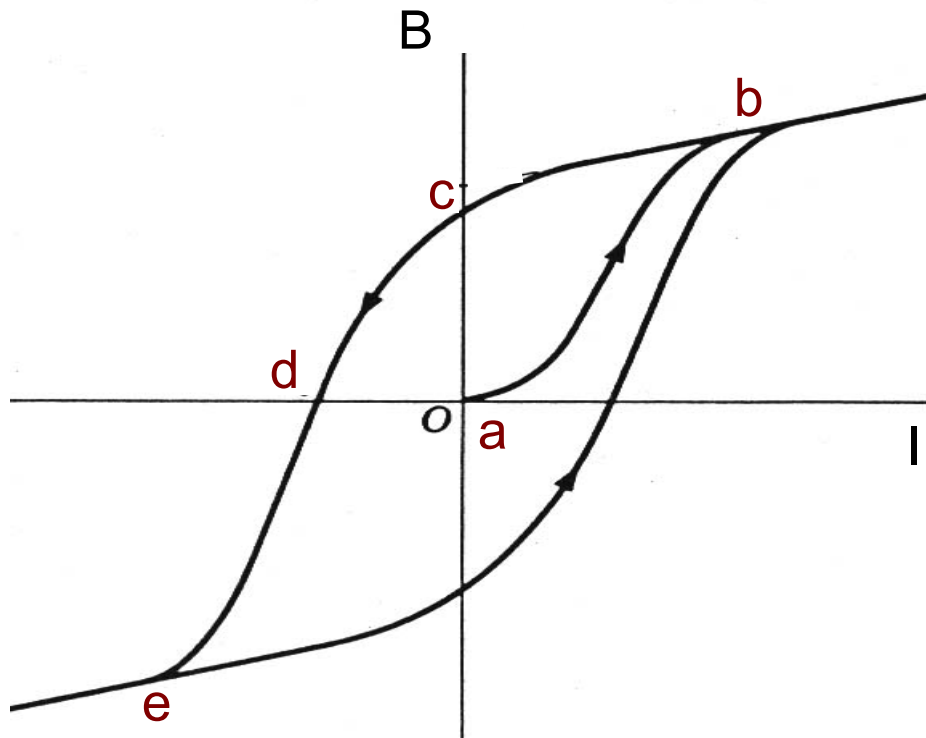

- a - start point
- b - saturation
- c - residual magnetization
- d - $B=0$
- e - saturation with $-B$



Summary

Summary:

- 1) First, we found the equations for dipole and quadrupole magnets, and analyzed the resulting force on the particle: We found that dipoles are used to bend particles along the “reference trajectory”, and quadrupoles are used to focus particles.
- 2) Then, we found that we could derive the equations for the B fields for any accelerator magnet from a general form.
- 3) Finally, we discussed the basic principles of magnet design.

Now we have the complete equations for B. We also have the equation for the force on a particle due to these fields: $F=q(v \times B)$

We can now write the equation of motion for a particle in an accelerator!



Explicit Terms Through Octupole

$$\begin{aligned}\operatorname{Re}(V) = & -\frac{cp}{e} \{(A_1 + B_1)x \\ & + (A_2 + B_2)\frac{x^2 - y^2}{2} \\ & + (A_3 + B_3)\frac{x^3 - 3xy^2}{6} \\ & + (A_4 + B_4)\frac{x^4 - 6x^2y^2 + y^4}{24} \\ & + \dots\}\end{aligned}$$

Dipole, n=1

Quadrupole, n=2

Sextupole, n=3

Octupole, n=4

$$\begin{aligned}\operatorname{Im}(V) = & -\frac{cp}{e} \{(A_1 - B_1)y \\ & + (A_2 - B_2)xy \\ & + (A_3 - B_3)\frac{3x^2y - y^3}{6} \\ & + (A_4 - B_4)\frac{x^3y - xy^3}{6} \\ & + \dots\}\end{aligned}$$

Dipole, n=1

Quadrupole, n=2

Sextupole, n=3

Octupole, n=4