



S. Belomestnykh

Superconducting RF for storage rings, ERLs, and linac-based FELs:

- **Lecture 5** *SRF system requirements and challenges*





Types of SRF accelerators

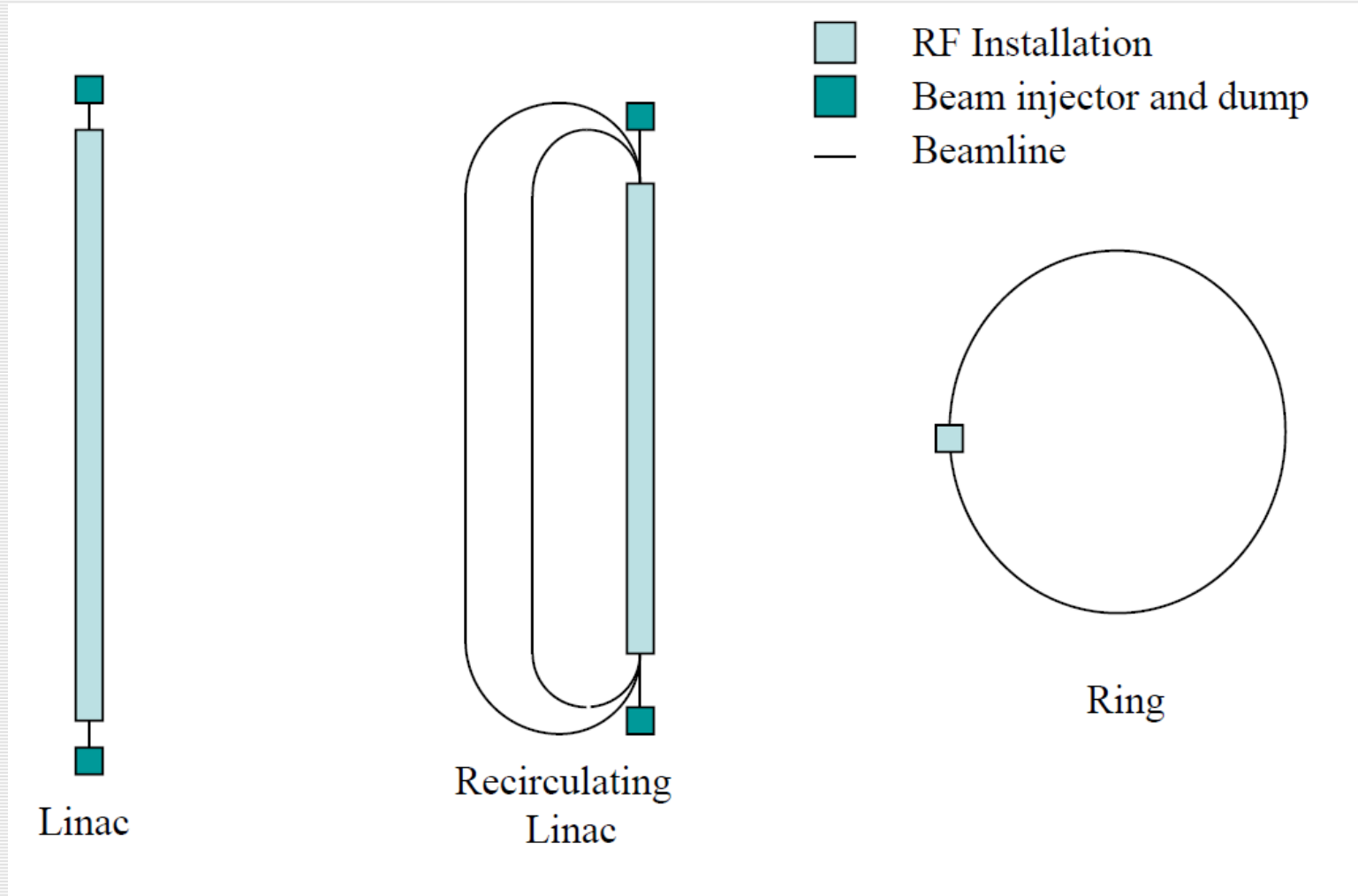



Typical requirements

	Examples	Accelerating gradient	RF power	HOM damping
Pulsed linacs	XFEL	High (> 20 MV/m)	High peak (> 250 kW), low average (~ 5 kW)	Moderate ($Q = 10^4 \dots 10^6$)
Low-current CW linacs	JLab FEL, ELBE	Moderate to low ($8 \dots 20$ MV/m)	Low ($5 \dots 15$ kW)	Relaxed
High-current ERLs	Cornell ERL, Electron cooler for RHIC	Moderate ($15 \dots 20$ MV/m)	Low (few kW)	Strong ($Q = 10^2 \dots 10^4$)
High-current ERL injectors	Cornell ERL injector, JLab FEL 100 mA injector	Moderate to low ($5 \dots 15$ MV/m)	High ($50 \dots 500$ kW)	Strong ($Q = 10^2 \dots 10^4$)
High-current storage rings	CESR, KEKB, LHC, CLS, TLS, BEPC-II, SOLEIL, DIAMOND, SRRF	Low ($5 \dots 10$ MV/m)	High (up to 400 kW)	Strong ($Q \sim 10^2$)

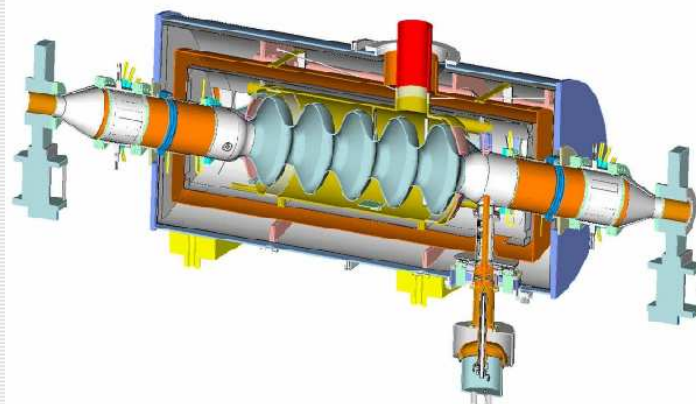



Storage rings

- A storage ring is a type of circular accelerator in which a particle beam with high average current may be kept circulating for a long period of time, up to many hours. Technically speaking, a storage ring is a type of synchrotron. However, a conventional synchrotron serves to accelerate particles from a low to a high energy with the aid of radio-frequency accelerating cavities; a storage ring, as the name suggests, keeps particles stored at a constant energy, and radio-frequency cavities are only used to replace energy lost through synchrotron radiation and other processes.
- The most common application of storage rings nowadays is to store electrons which then radiate synchrotron radiation. There are over 50 facilities based on electron storage rings in the world today, used for a variety of studies in chemistry, biology and material sciences.
- The original and still best known application of storage rings is their use in particle colliders, in which two counter-rotating beams of stored particles are brought into collision at discrete locations, the results of the subatomic interactions being studied in a surrounding particle detector. Examples of such facilities are CESR, KEKB, LHC, LEP, PEP-II, RHIC, Tevatron and HERA.

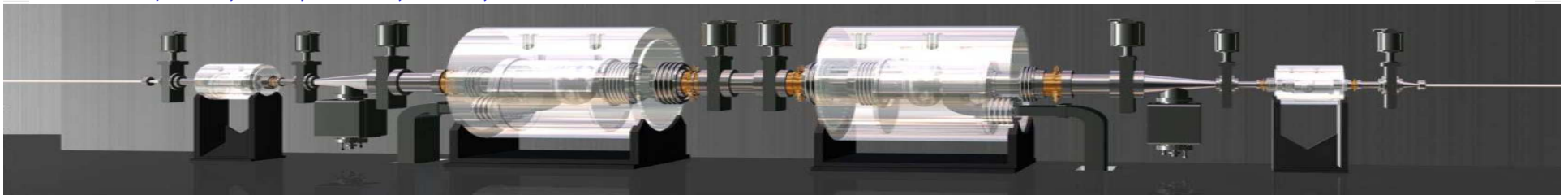
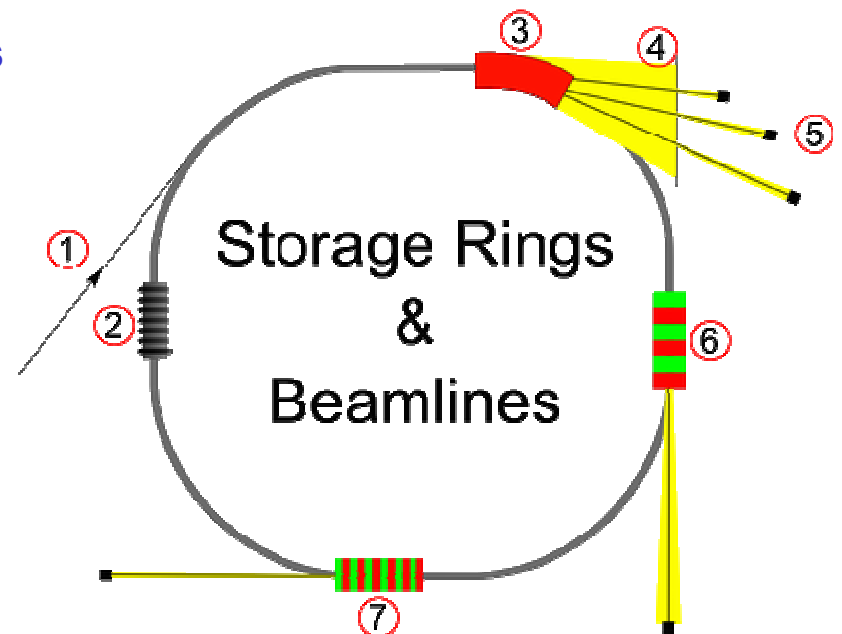



- Deliver RF power to a high-current beam(s).
- Provide high voltage for high synchrotron tune and short bunch length (colliders).
- Provide enough voltage for good quantum lifetime.
- Provide voltage for good energy acceptance.
- Suppress parasitic interaction of a beam with higher-order modes (HOMs) by providing good HOM damping (concept of so-called HOM-damped, HOM-free or single-mode cavity).

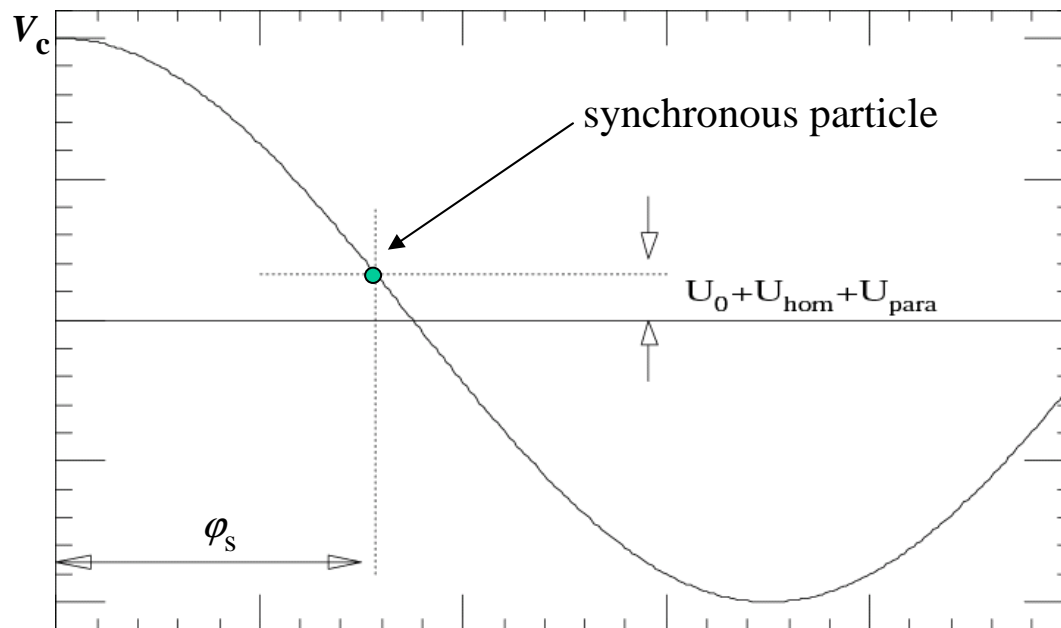

$$P_{\text{beam}} = I_{\text{beam}} \cdot (U_0 + U_{\text{hom}} + U_{\text{para}})$$

$$f_s = f_{\text{rev}} \sqrt{\frac{\alpha \cdot h \cdot V_c \sin \varphi_s}{2\pi E/e}}$$

$$\sigma_z = \frac{c \cdot \alpha}{\omega_s} \cdot \frac{\sigma_E}{E}$$



- CW operation at higher gradients (≤ 10 MV/m) \rightarrow fewer cavities \rightarrow save space. Gradients in normal conducting cavities are limited by heat dissipation in the cavity walls.
- High wall-plug-to-beam power conversion efficiency.
- Can transfer a lot of RF power to the beam (demonstrated up to 400 kW per input coupler at KEK-B).
- As there is no hard limit on power dissipation, we gain freedom to adapt design better suited to the accelerator requirements. This allows, for example, the beam-tube size to be increased.
- Large beam aperture reduces interaction of the beam with the cavity \rightarrow low impedance for high-bunch-charge beams.
- Easier HOM damping ($Q \sim 10^2$) \rightarrow higher bunched beam instability thresholds. HOM power is absorbed either in beam-line ferrite absorbers or coupled outside via coaxial loop couplers.
- Conclusion: superconducting HOM-damped, single-cell cavities are ideal for storage rungs.

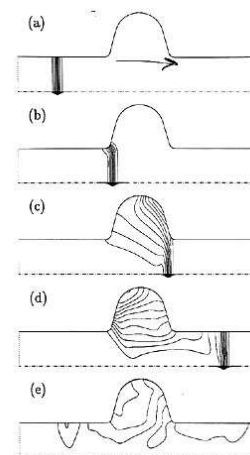
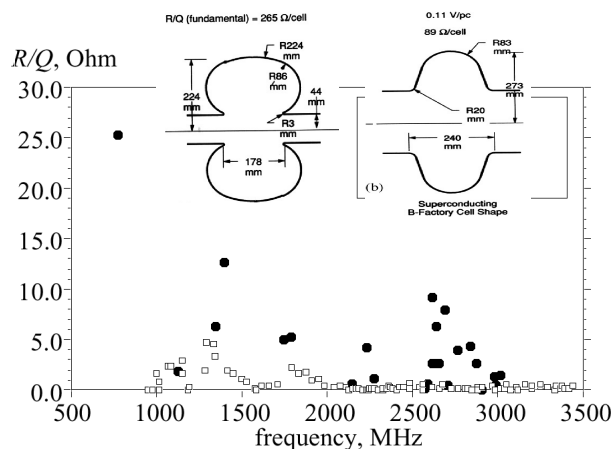



Example: RF options for a 3rd generation light source

Suppose we are designing a third generation X-ray light source based on an electron storage ring. RF system is required to provide the total accelerating voltage of 2.4 MV and deliver 300 kW of RF power to beam. Let us compare two state-of-the-art 500 MHz RF systems: normal conducting PEP-II cavity and superconducting CESR-B cavity, operating at 4.5 K.

Parameter	PEP-II cavity	CESR-B cavity
Frequency	500 MHz	500 MHz
Number of cavities	3	1
R/Q	230 Ohm	89 Ohm
Q_0	3×10^4	1×10^9
Acc. voltage per cavity	0.8 MV	2.4 MV
Cavity wall power dissipation	278 kW	65 W
Total RF power	578 kW	300 kW
RF efficiency	0.5	0.5
Refrigeration efficiency	-	5×10^{-3}
Total AC power	1156 kW	613 kW





- During the last decade a qualitative change has happened: with successful and reliable operation of HOM damped cavities at CESR and KEKB and the technology transfer to industry, SRF has become the readily available technology of choice for new and small labs with no prior SRF experience.
- Proliferation of superconducting insertion devices made having a cryogenic plant the necessity for every contemporary light source thus providing infrastructure for SRF as well.
- The light sources are user facilities → hence there is emphasis on reliable operation.
- Thus SRF has become a “workhorse” application.
- There are two modes of operation used in SR: active (fundamental RF systems) and passive (3rd harmonic cavities for bunch lengthening).

Fundamental RF systems

- Moderate (by SRF standards) accelerating gradients of 4...8 MV/m
- Relatively low frequency 352...500 MHz, hence operation at ~4.5 K
- $Q_0 \approx 10^9$
- Single-cell cavities with strong HOM dampers ($Q_{\text{HOM}} = 10^2 \dots 10^3$)
- High average RF power per coupler

Decision Making for the SRF Project at NSRRC (1997-2005)

- **Guarantee the photon light stability at a higher beam current** by using a HOM-free SRF cavity – SC cavity is better than conventional one;
 - Transverse feedback system is absolutely required to stabilize the photon beam;
- **Doubling the photon intensity by operating at 500 mA in decay mode**
 - Doubling of photon intensity has been achieved at a beam current less than 280 mA in top-up mode.
- **Reduce the cavity occupied-length** for installing one more insertion device – One cavity for SRF option but two for conventional cavity;
 - Superconducting wiggler is installed in down-stream of the same straight section.
- **Simplify the configuration of RF plant** by using one cavity, one klystron, and one low level rf system;
 - Low-level rf system is challenged for operation with heavy beam loading.
- **Increase the Touschek lifetime** by enlarging the RF gap voltage (from currently 0.8 MV) to its optimal value, i.e. 1.6 MV
- Build-up the **application of SRF technology to accelerators in Taiwan**.
 - We are still in the learning stage...



SRF for bunch length manipulation

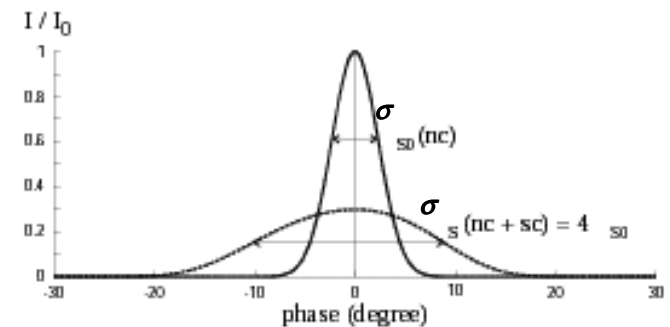
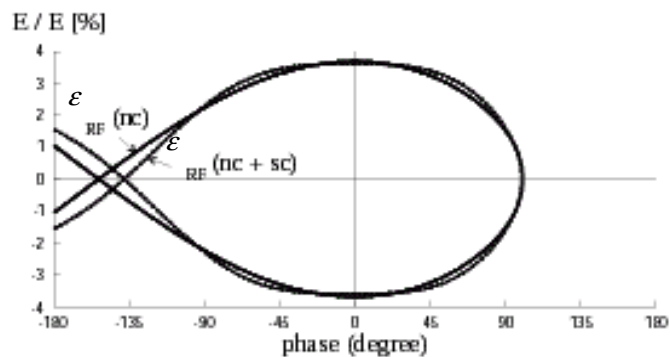
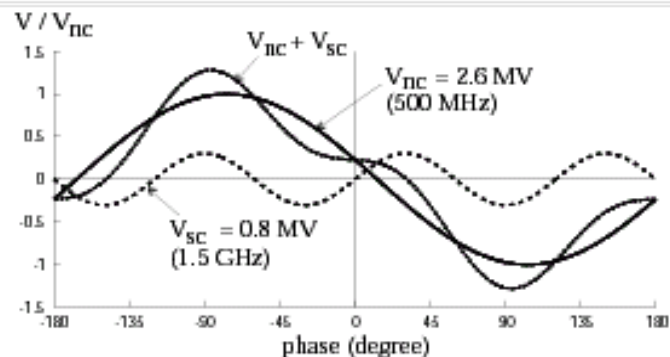

- Bunch shortening to enhance luminosity (colliders).
- Bunch lengthening to improve the Touschek beam lifetime (light sources).
- Added benefit: improved beam stability due to Landau damping.
- Typically 3rd harmonic beam-driven (passive) cavities are used.

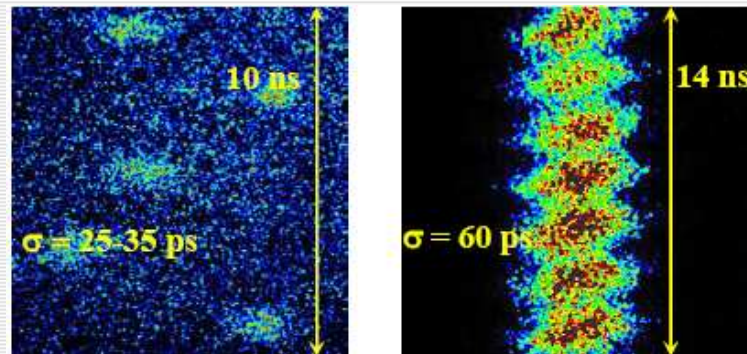
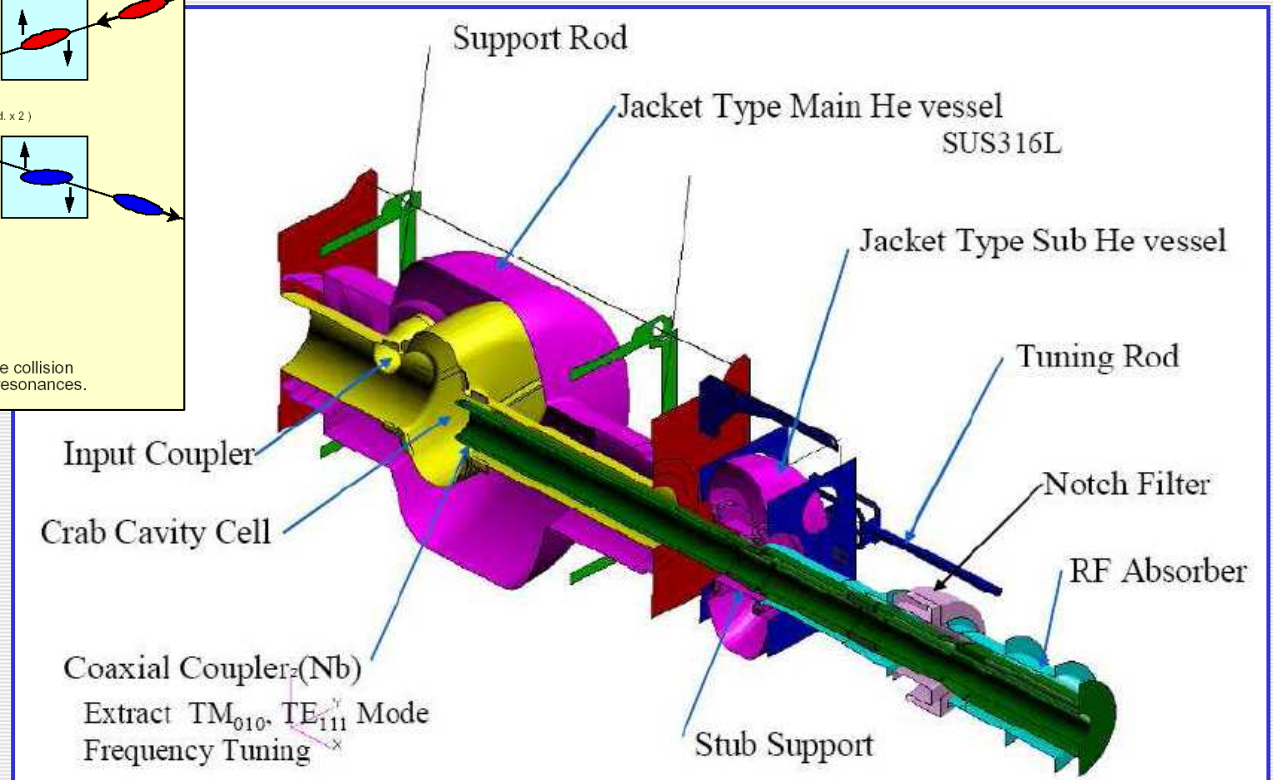
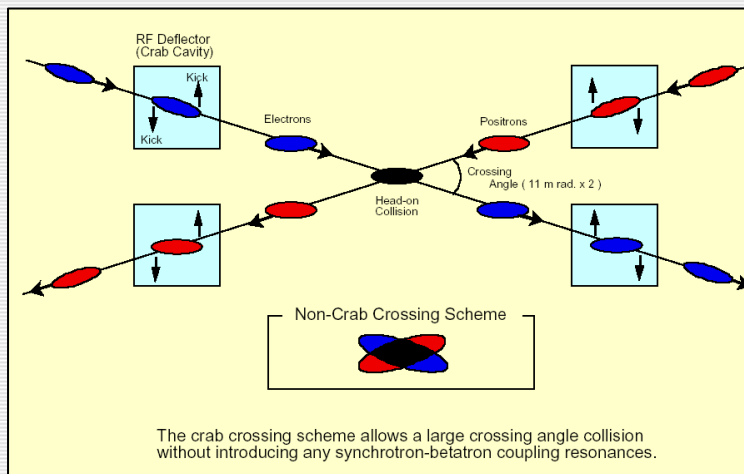

Figure 5: 250 mA, 2.0 GeV, streak camera images. On the left S3HC detuned, longitudinal oscillations present; on the right S3HC tuned, stable beam. Theoretical σ without S3HC is 18 ps.



Crab cavities

- These cavities are used in colliders (KEKB) to reduce synchro-betatron oscillations coupling in a scheme with collisions at large crossing angles.
- A crab cavity provides a transverse kick to bunches so that they collide head-on.
- Its operating mode is TM_{110} deflecting mode.





SRF cavities for storage rings



KEKB crab cavity



SOLEIL cavity

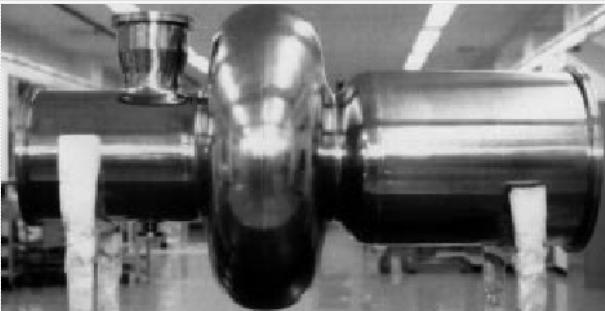

KEKB fundamental RF cavity



CESR cavities





Limitations of SR light sources

- The characteristics of x-rays are determined by the qualities of electron beams.
- In a storage ring, beam properties are determined by an equilibrium between radiation damping and quantum fluctuations with the emission of SR.
- In existing 3rd generation rings, beam characteristics are near limits: storage ring technology is at the point of diminishing returns
- Future improvements will come at enormous cost with larger rings.

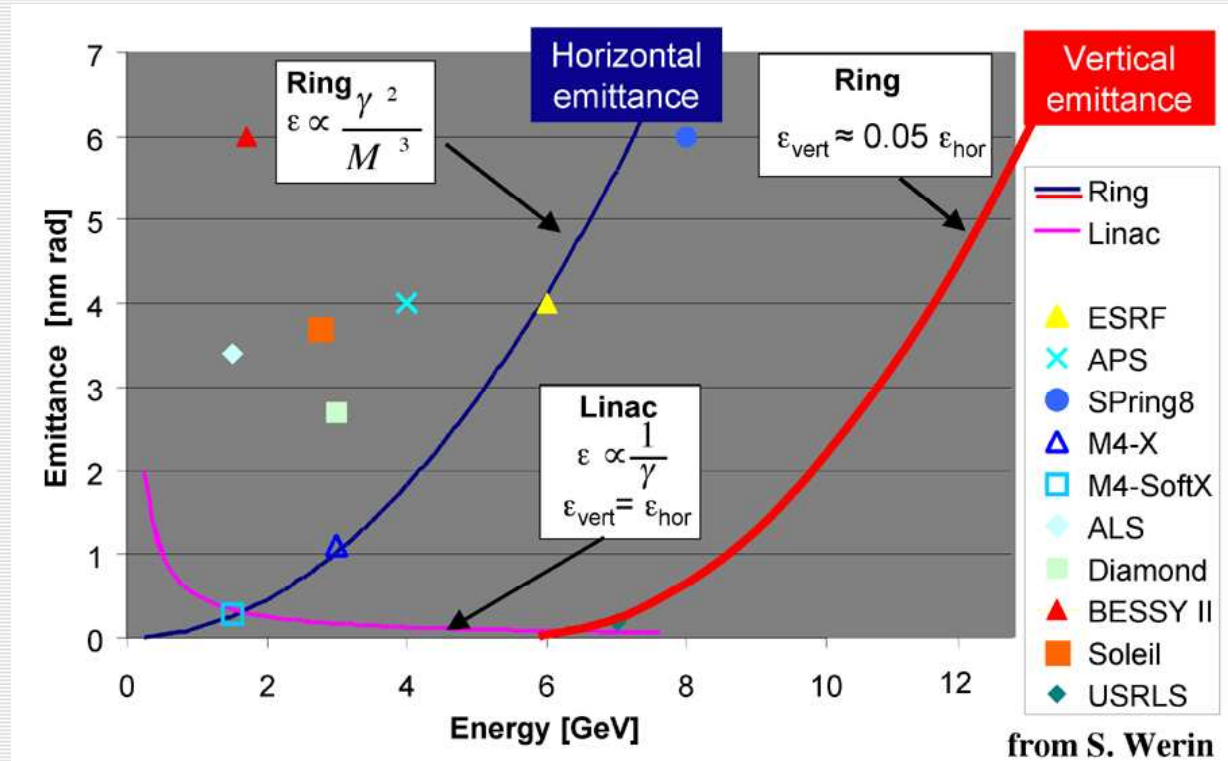



Energy Recovery Linacs

- In the Energy Recovery Linac (ERL) electrons are not stored, so constraints of beam equilibrium never become a limit.
- A CW superconducting linac accelerates bunches to high energy, while preserving the salient beam characteristics. Multicell cavities are used to reduce the footprint of the facility.
- High-gradient, low-impedance SRF structures allow the preservation of the exceptional beam quality produced by the injector.
- After acceleration bunches pass through undulators to produce SR beams with unprecedented characteristics.
- **The problem is that the beam currents required for high radiation flux carry enormous power.**
- For example, a 5 GeV, 100 mA electron beam carries 500 MW of beam power!
- ERLs resolve the power dilemma by reusing the beam energy.
- After producing SR, the electrons re-enter the linac, but 180° out of accelerating phase.
- The bunches decelerate and yield their energy back to the electromagnetic field in the linac.
- Bunches emerging from the linac with the low injector energy are sent to a beam dump.
- The energy recovered by the linac accelerates new electrons.
- For the best stability, CW operation is a must.

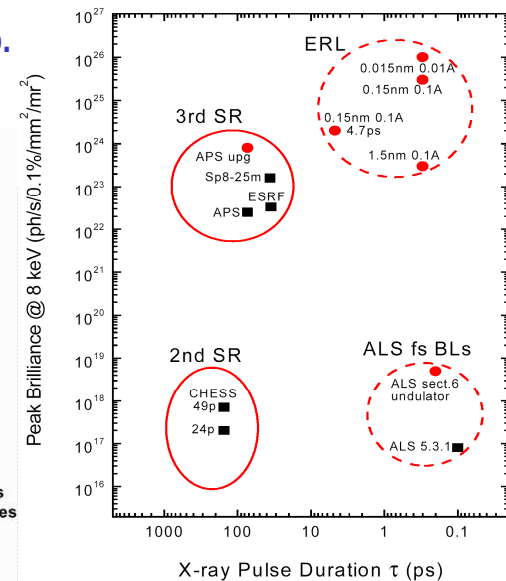
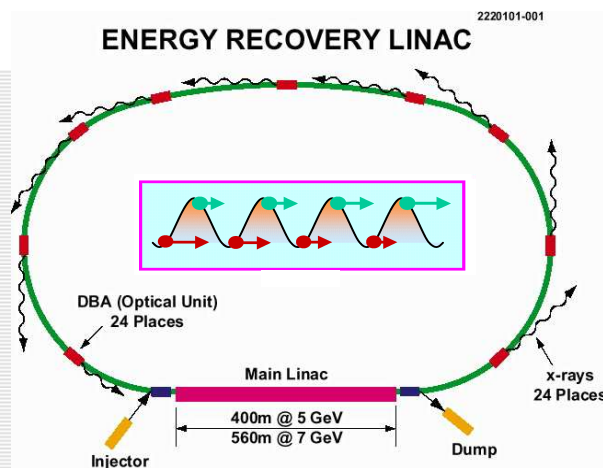



- Better electron beam gives better X-ray source
- Difference between storage ring and linac:

Storage Ring

- Beam goes around billion times
- ⇒ Bunches expand over time (fundamental physics effects) until they reach equilibrium after about 10,000 turns

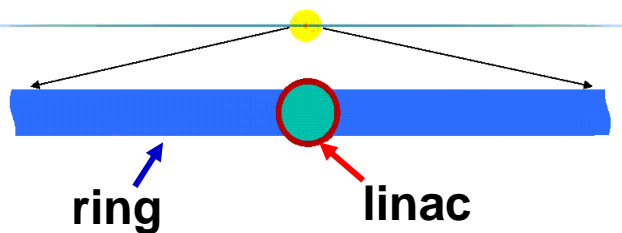

⇒ Smaller beams

Linac

- Beam goes around only once
- ⇒ No equilibrium effects
- ⇒ Beam size & pulse length limited by injector

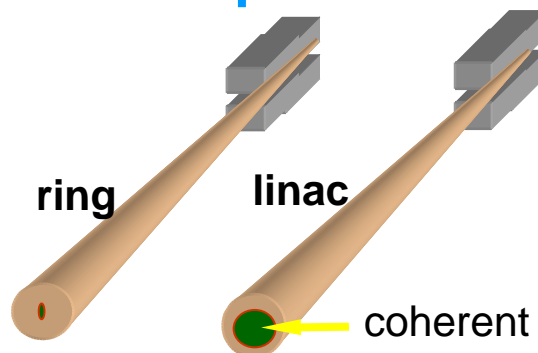

Much higher coherence fraction

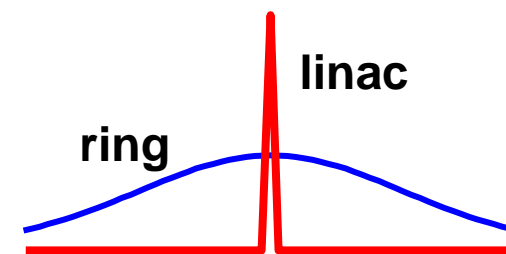

Shorter bunches



ERL beams, in addition to generation of X-rays from insertion devices, can be used for:

- Free-Electron Lasers, tunable sources of coherent radiation
- Electron cooling of ion beams
- Electron-ion collisions

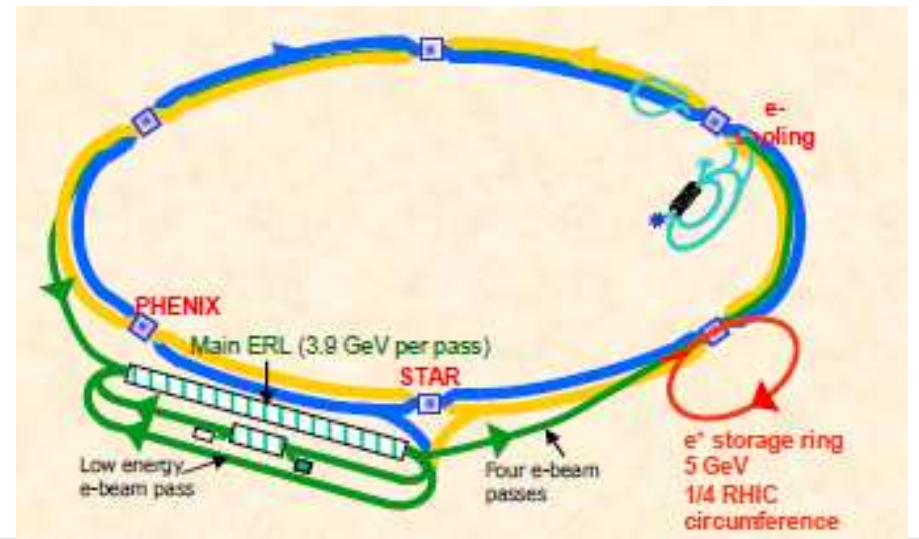
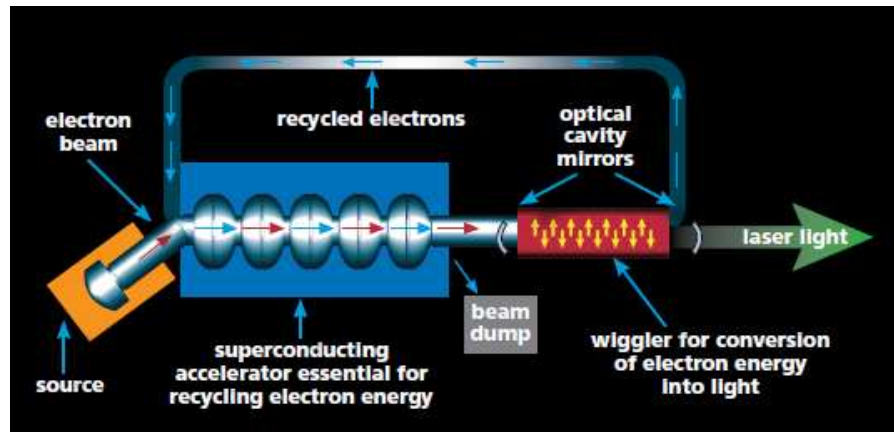
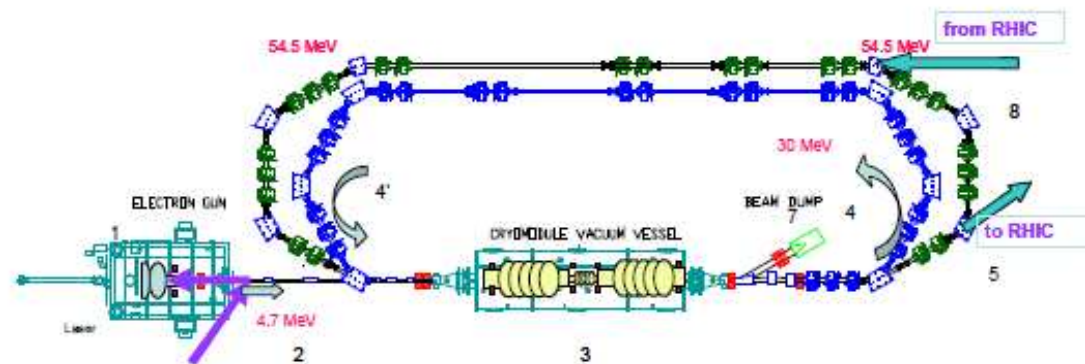



Features:

- With the exception of the injector, the required RF power is nearly independent of beam current: increased overall system efficiency; reduced RF capital cost.
- The electron beam power to be disposed of at beam dumps is reduced by ratio of E_{max}/E_{inj} : thermal design of beam dumps is simplified; if the beam is dumped below the neutron production threshold, then the induced radioactivity (shielding problem) will be reduced.

Challenges:

- Multipass Beam Breakup (BBU) due to interaction with dipole HOMs.
- BBU is the major limitation of the beam current in ERLs.
- Strong damping of HOMs in multi-cell cavities.
- HOM power dissipation may be high.
- Very tight requirements to RF amplitude/phase stability at high Q_L .
- High Q_0 is necessary to reduce cryogenic power.



Linac-based FELs

- SRF straight linacs have to operate in pulsed mode if high energies are needed. Otherwise operating cost will be too high.
- Higher gradients (≥ 25 MV/m) are desirable and can be achieved than in CW mode.
- HOM damping requirements are relaxed compared to ERLs.
- Self-Amplified Spontaneous Emission (SASE) process is used at ultra-short wavelengths, where mirrors are not available.
- Examples: FLASH and XFEL facilities at DESY.

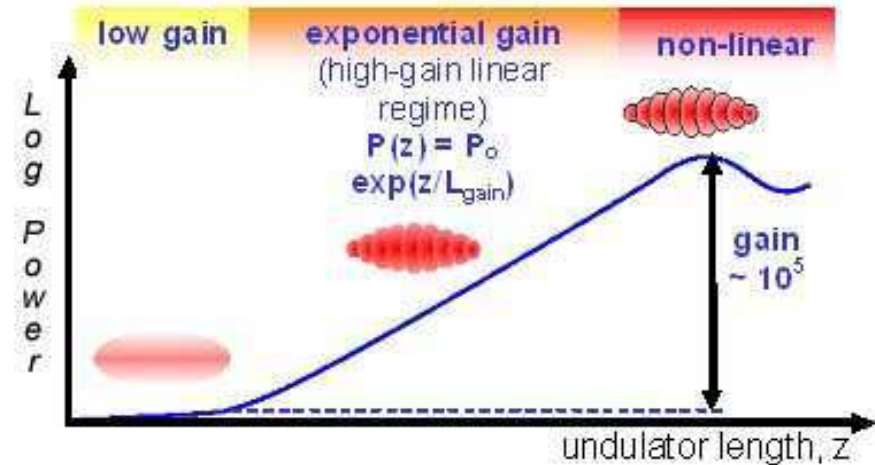
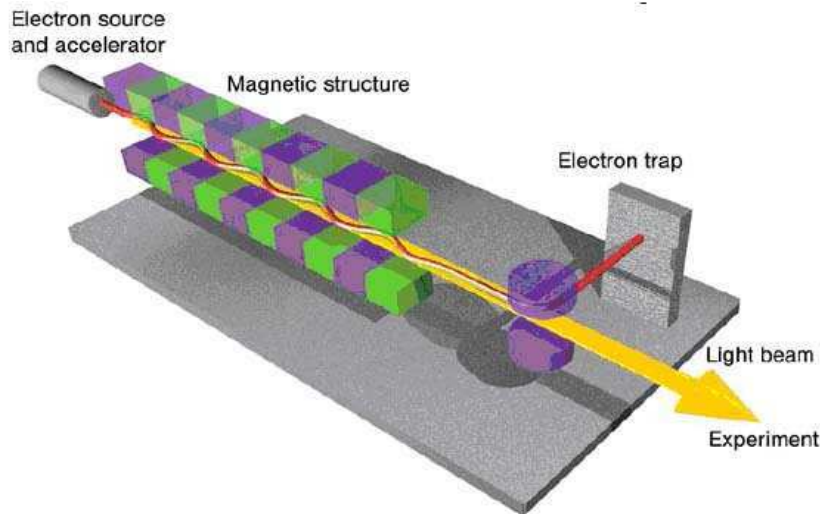



What have we learned?

- Single-cell SRF cavities are used in storage rings: limitation is usually due to capability of an input coupler to deliver RF power.
- Strong damping of HOMs is critical for the ring operation (coupled-bunch instabilities).
- SRF cavities are also used for bunch length manipulation and as crab cavities.
- Multi-cell cavities have to be used in ERLs and linacs to reduce the facility footprint.
- BBU is the major limiting factor for the average beam current in ERLs, hence strong HOM damping is required.
- RF amplitude and phase stability requirements are very tight in ERLs.

★ We will discuss beam-cavity interaction issues in the next lecture.