

Lecture 4

- **Boundary Conditions**
- **Poynting Vector**
- **Transmission Line**

A. Nassiri



Proof of boundary conditions - \underline{D}_n

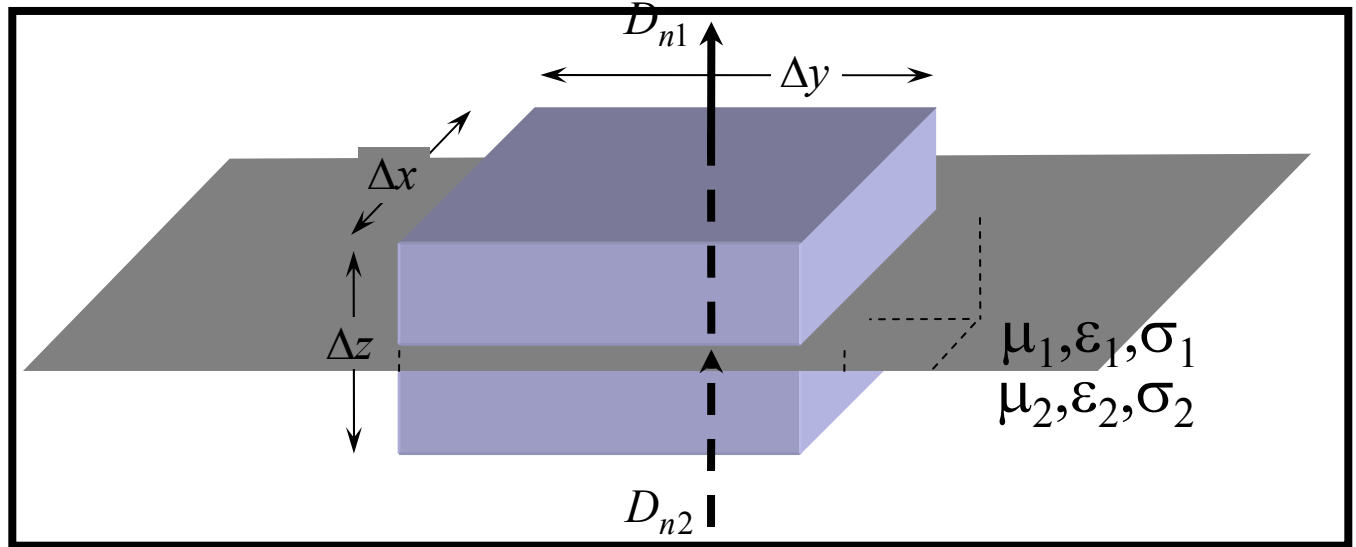

- The integral form of Gauss' law for electrostatics is:

$$\oiint \mathbf{D} \cdot d\mathbf{A} = \iiint_V \rho dV$$

applied to the box gives

$$D_{n1} \Delta x \Delta y - D_{n2} \Delta x \Delta y + \Psi_{\text{edge}} = \rho_s \Delta x \Delta y$$

As $dz \rightarrow 0, \Psi_{\text{edge}} \rightarrow 0$ hence

$$D_{n1} - D_{n2} = \rho_s$$

The change in the normal component of \mathbf{D} at a boundary is equal to the surface charge density

Proof of boundary conditions - $\underline{\mathbf{B}}_n$

- Proof follows same argument as for D_n
- The integral form of Gauss' law for magnetostatics is

$$\oiint \mathbf{B} \cdot d\mathbf{A} = 0$$

– there are no isolated magnetic poles

$$B_{n1}\Delta x\Delta y - B_{n2}\Delta x\Delta y + \Psi_{\text{edge}} = 0$$

\Rightarrow

$$B_{n1} = B_{n2}$$

The normal component of \mathbf{B} at a boundary is always continuous at a boundary



Conditions at a perfect conductor

- In a perfect conductor σ is infinite
- Practical conductors (copper, aluminium silver) have very large σ and field solutions assuming infinite σ can be accurate enough for many applications
 - Finite values of conductivity are important in calculating Ohmic loss
- For a conducting medium
 - $\mathbf{J} = \sigma \mathbf{E}$
 - infinite $\sigma \Rightarrow$ infinite \mathbf{J}
 - More practically, σ is very large, \mathbf{E} is very small (≈ 0) and \mathbf{J} is finite



Conditions at a perfect conductor

- It will be shown that at high frequencies \mathbf{J} is confined to a surface layer with a depth known as the *skin depth*
- With increasing frequency and conductivity the skin depth, δx becomes thinner

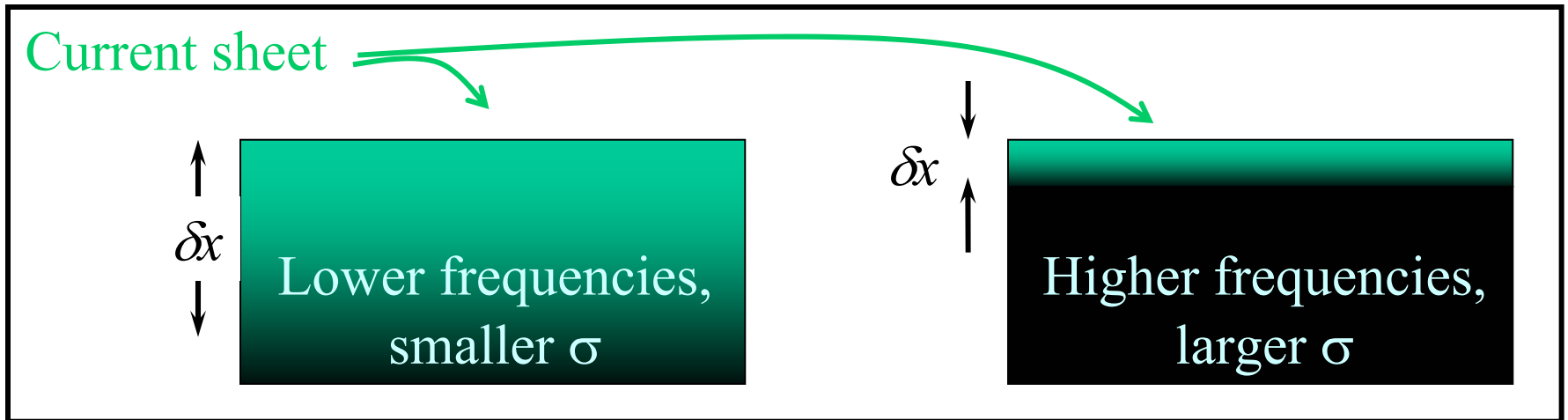

- It becomes more appropriate to consider the current density in terms of current per unit width with:

$$\lim_{\delta x \rightarrow 0} \mathbf{J} \delta x = \mathbf{J}_s \text{ A/m}$$

Conditions at a perfect conductor cont.

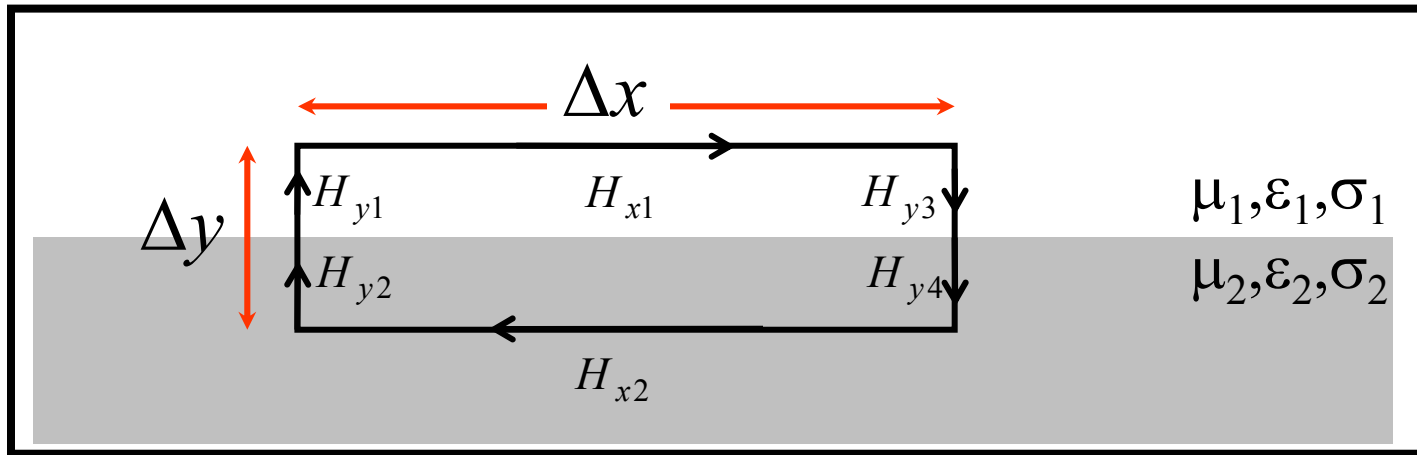

- Ampere's law:

$$\oint \mathbf{H} \cdot d\mathbf{s} = \iint_A \left(\frac{\partial \mathbf{D}}{\partial t} + \mathbf{J} \right) \cdot d\mathbf{A}$$

$$H_{y2} \frac{\Delta y}{2} + H_{y1} \frac{\Delta y}{2} + H_{x1} \Delta x - H_{y3} \frac{\Delta y}{2} - H_{y4} \frac{\Delta y}{2} - H_{x2} \Delta x = \left(\frac{\partial D_z}{\partial t} + J_z \right) \Delta x \Delta y$$

As $\Delta y \rightarrow 0$, $\frac{\partial D_z}{\partial t} \Delta x \Delta y \rightarrow 0$, $J_z \Delta x \Delta y \rightarrow \Delta x J_{sz}$

$$H_{x1} - H_{x2} = J_{sz}$$

That is, the tangential component of \mathbf{H} is discontinuous by an amount equal to the surface current density

Summary of Boundary conditions

At a boundary between non-conducting media

$$E_{t1} = E_{t2}$$

$$H_{t1} = H_{t2}$$

$$D_{n1} = D_{n2}$$

$$B_{n1} = B_{n2}$$

\equiv

$$n \times (\mathbf{E}_1 - \mathbf{E}_2) = 0$$

$$n \times (\mathbf{H}_1 - \mathbf{H}_2) = 0$$

$$n \cdot (\mathbf{D}_1 - \mathbf{D}_2) = 0$$

$$n \cdot (\mathbf{B}_1 - \mathbf{B}_2) = 0$$

At a metallic boundary (large σ)

$$n \times (\mathbf{E}_1 - \mathbf{E}_2) = 0$$

$$n \times (\mathbf{H}_1 - \mathbf{H}_2) = 0$$

$$n \cdot (\mathbf{D}_1 - \mathbf{D}_2) = \rho_s$$

$$n \cdot (\mathbf{B}_1 - \mathbf{B}_2) = 0$$

At a perfectly conducting boundary

$$n \times \mathbf{E}_1 = 0$$

$$n \times \mathbf{H}_1 = \mathbf{J}_s$$

$$n \cdot \mathbf{D}_1 = \rho_s$$

$$n \cdot \mathbf{B}_1 = 0$$



Reflection and refraction of plane waves

- At a discontinuity the change in μ , ϵ and σ results in partial reflection and transmission of a wave
- For example, consider normal incidence:

$$\text{Incident wave} = E_i e^{j(\omega t - \beta z)}$$

$$\text{Reflected wave} = E_r e^{j(\omega t + \beta z)}$$

- Where E_r is a complex number determined by the boundary conditions



Reflection at a perfect conductor

- Tangential \mathbf{E} is continuous across the boundary
- For a perfect conductor \mathbf{E} just inside the surface is zero
 - E just outside the conductor must be zero

$$E_i + E_r = 0$$
$$\Rightarrow E_i = -E_r$$

- Amplitude of reflected wave is equal to amplitude of incident wave, but reversed in phase



Standing waves

- Resultant wave at a distance $-z$ from the interface is the sum of the incident and reflected waves

$$\begin{aligned} E_T(z, t) &= \text{incident wave} + \text{reflected wave} \\ &= E_i e^{j(\omega t - \beta z)} + E_r e^{j(\omega t + \beta z)} \\ &= E_i \left(e^{-j\beta z} - e^{j\beta z} \right) e^{j\omega t} \\ &= -2jE_i \sin \beta z e^{j\omega t} \end{aligned}$$

$$\sin \phi = \frac{e^{j\phi} - e^{-j\phi}}{2j}$$

and if E_i is chosen to be real

$$\begin{aligned} E_T(z, t) &= \text{Re} \left\{ -2jE_i \sin \beta z (\cos \omega t + j \sin \omega t) \right\} \\ &= 2E_i \sin \beta z \sin \omega t \end{aligned}$$



Standing waves cont...

$$E_T(z, t) = 2E_i \sin \beta z \sin \omega t$$

- Incident and reflected wave combine to produce a standing wave whose amplitude varies as a function ($\sin \beta z$) of displacement from the interface
- Maximum amplitude is twice that of incident fields



Reflection from a perfect conductor

- resultant wave
- >--- incident wave
- < reflected wave
- transmitted wave

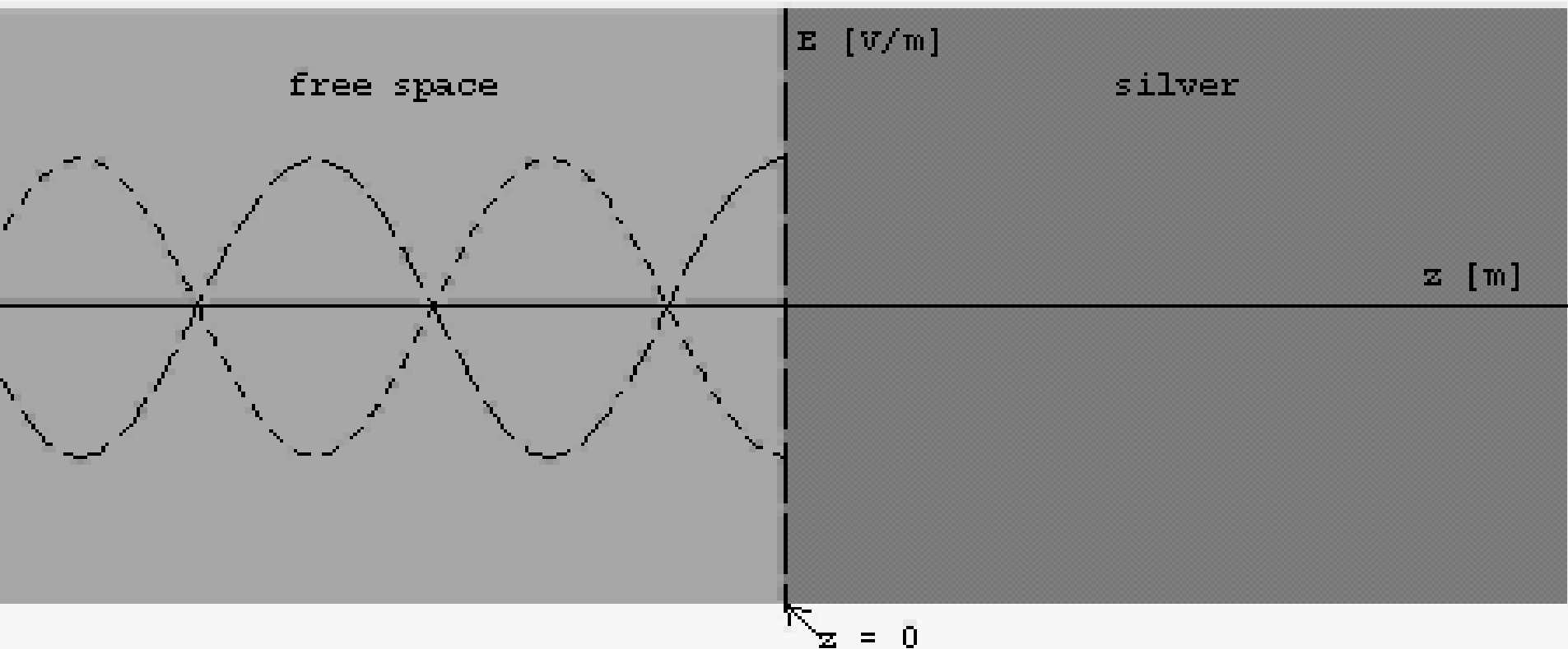

Reflection from a perfect conductor

- Direction of propagation is given by $\mathbf{E} \times \mathbf{H}$

If the incident wave is polarised along the y axis:

$$E_i = \mathbf{a}_y E_{yi}$$

$$\Rightarrow H_i = -\mathbf{a}_x H_{xi}$$

then
$$\mathbf{E} \times \mathbf{H} = (-\mathbf{a}_y \times \mathbf{a}_x) E_{yi} H_{xi}$$
$$= +\mathbf{a}_z E_{yi} H_{xi}$$

That is, a z -directed wave.

For the reflected wave $\mathbf{E} \times \mathbf{H} = -\mathbf{a}_z E_{yi} H_{xi}$ and $E_r = -\mathbf{a}_y E_{yi}$

So $H_r = -\mathbf{a}_x H_{xi} = H_i$ and the magnetic field is reflected without change in phase



Reflection from a perfect conductor

- Given that $\cos \phi = \frac{e^{j\phi} + e^{-j\phi}}{2}$

$$\begin{aligned}H_T(z, t) &= H_i e^{j(\omega t - \beta z)} + H_r e^{j(\omega t + \beta z)} \\&= H_i \left(e^{j\beta z} + e^{-j\beta z} \right) e^{j\omega t} \\&= 2H_i \cos \beta z e^{j\omega t}\end{aligned}$$

As for E_i , H_i is real (they are in phase), therefore

$$H_T(z, t) = \text{Re}\{2H_i \cos \beta z (\cos \omega t + j \sin \omega t)\} = 2H_i \cos \beta z \cos \omega t$$



Reflection from a perfect conductor

$$H_T(z, t) = 2H_i \cos \beta z \cos \omega t$$

- Resultant magnetic field strength also has a standing-wave distribution
- In contrast to \mathbf{E} , \mathbf{H} has a maximum at the surface and zeros at $(2n+1)\lambda/4$ from the surface:

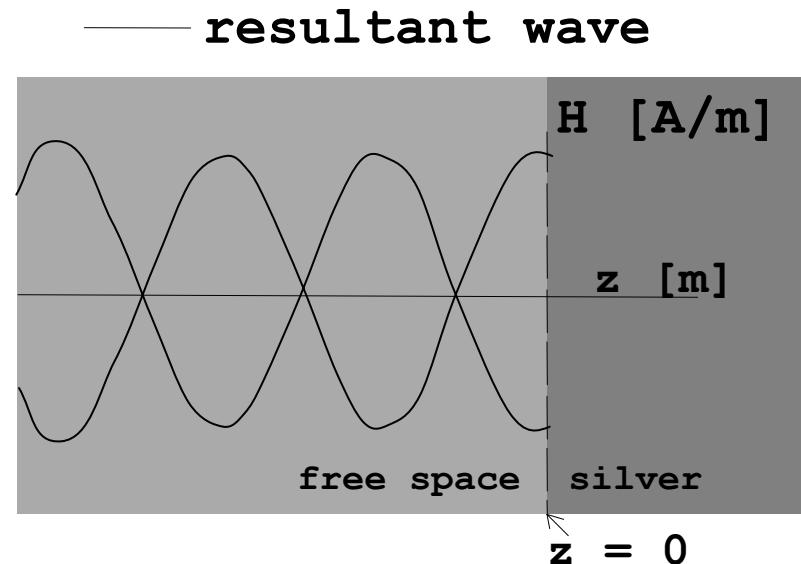
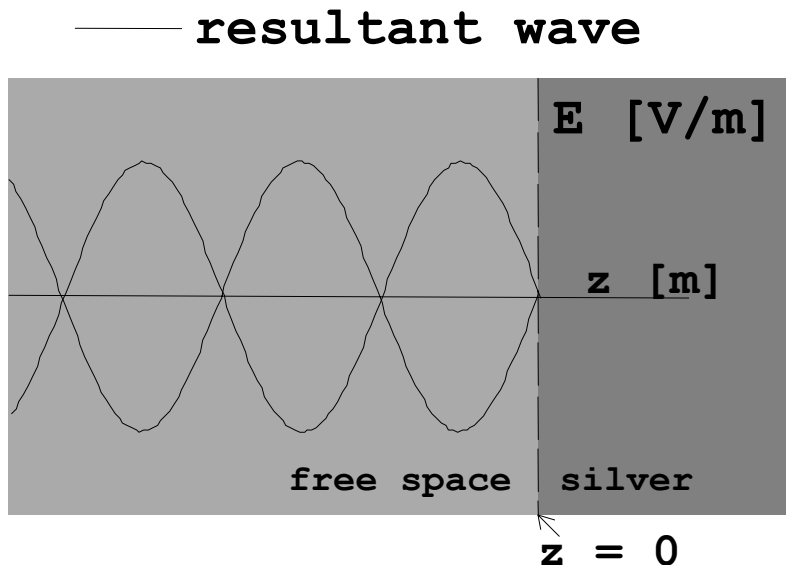

Reflection from a perfect conductor

$$E_T(z, t) = 2E_i \sin \beta z \sin \omega t$$

$$H_T(z, t) = 2H_i \cos \beta z \cos \omega t$$

- E_T and H_T are $\pi/2$ out of phase ($\sin \omega t = \cos(\omega t - \pi / 2)$)
- No net power flow as expected
 - power flow in $+z$ direction is equal to power flow in $-z$ direction



Reflection by a perfect dielectric

- Reflection by a perfect dielectric ($\mathbf{J}=\sigma\mathbf{E}=\mathbf{0}$)
 - no loss
- Wave is incident normally
 - \mathbf{E} and \mathbf{H} parallel to surface
- There are incident, reflected (in medium 1) and transmitted waves (in medium 2):



Reflection from a lossless dielectric

- resultant wave
- --- incident wave
- < reflected wave
- transmitted wave

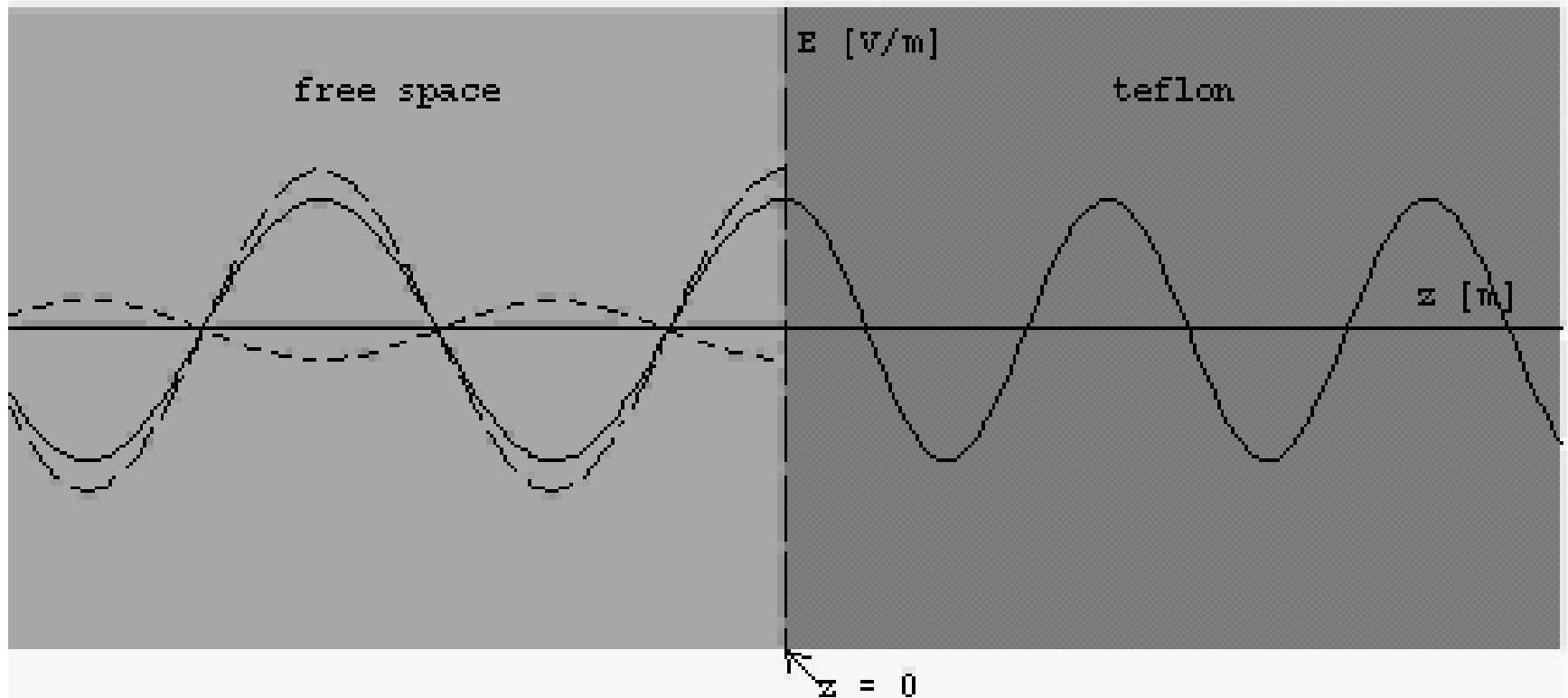

Reflection by a lossless dielectric

$$\begin{aligned}E_i &= \eta_1 H_i \\E_r &= -\eta_1 H_r \\E_t &= \eta_2 H_t\end{aligned}$$

$$\eta = \sqrt{\frac{j\omega\mu}{\sigma + j\omega\epsilon_0\epsilon_r}} = \sqrt{\frac{\mu}{\epsilon}}$$

- Continuity of E and H at boundary requires:

$$E_i + E_r = E_t$$

$$H_i + H_r = H_t$$

Which can be combined to give

$$H_i + H_r = \frac{1}{\eta_1}(E_i - E_r) = H_t = \frac{1}{\eta_2}E_t = \frac{1}{\eta_2}(E_i + E_r)$$

$$\frac{1}{\eta_1}(E_i - E_r) = \frac{1}{\eta_2}(E_i + E_r)$$

\Rightarrow

$$\rho_E = \frac{E_r}{E_i} = \frac{\eta_2 - \eta_1}{\eta_2 + \eta_1}$$

$$\Rightarrow \eta_2(E_i - E_r) = \eta_1(E_i + E_r)$$

$$\Rightarrow E_i(\eta_2 - \eta_1) = E_r(\eta_2 + \eta_1)$$

The reflection coefficient



Reflection by a lossless dielectric

$$E_i + E_r = E_t$$
$$H_i + H_r = H_t$$

- Similarly

$$\tau_E = \frac{E_t}{E_i} = \frac{E_r + E_i}{E_i} = \frac{E_r}{E_i} + 1 = \frac{\eta_2 - \eta_1}{\eta_2 + \eta_1} + \frac{\eta_2 + \eta_1}{\eta_2 + \eta_1} = \frac{2\eta_2}{\eta_2 + \eta_1}$$

$$\tau_E = \frac{2\eta_2}{\eta_2 + \eta_1}$$

The transmission coefficient



Reflection by a lossless dielectric

- Furthermore:

$$\frac{H_r}{H_i} = -\frac{E_r}{E_i} = \rho_H$$
$$\frac{H_t}{H_i} = \frac{\eta_1 E_t}{\eta_2 E_i} = \frac{\eta_1}{\eta_2} \frac{2\eta_2}{\eta_2 + \eta_1} = \frac{2\eta_1}{\eta_2 + \eta_1} \tau_H$$

And because $\mu = \mu_0$ for all low-loss dielectrics

$$\rho_E = \frac{E_r}{E_i} = \frac{\sqrt{\epsilon_1} - \sqrt{\epsilon_2}}{\sqrt{\epsilon_1} + \sqrt{\epsilon_2}} = \frac{n_1 - n_2}{n_1 + n_2} = -\rho_H$$
$$\tau_E = \frac{E_r}{E_i} = \frac{2\sqrt{\epsilon_1}}{\sqrt{\epsilon_1} + \sqrt{\epsilon_2}} = \frac{2n_1}{n_1 + n_2}$$
$$\tau_H = \frac{2\sqrt{\epsilon_2}}{\sqrt{\epsilon_1} + \sqrt{\epsilon_2}} = \frac{2n_2}{n_1 + n_2}$$



Energy Transport - Poynting Vector

Electric and Magnetic Energy Density:

For an electromagnetic plane wave

$$\bar{E}_y(x, t) = \bar{E}_0 \sin(kx - \omega t)$$

$$\bar{B}_z(x, t) = \bar{B}_0 \sin(kx - \omega t)$$

where $B_0 = E_0 / c$

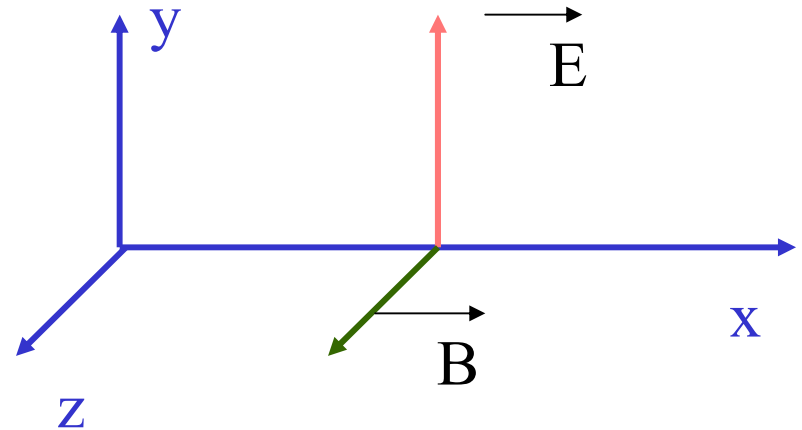

The electric energy density is given by

$$u_E = \frac{1}{2} \epsilon_0 E^2 = \frac{1}{2} \epsilon_0 \bar{E}_0^2 \sin^2(kx - \omega t) \text{ and the magnetic energy is}$$

$$u_B = \frac{1}{2\mu_0} B^2 = \frac{1}{2\mu_0 c} \bar{E}^2 = u_E$$

Note: I used $\bar{E} = c\bar{B}$

Energy Transport - Poynting Vector cont.

Thus, for light the electric and the magnetic field energy densities are equal and the total energy density is

$$u_{total} = u_E + u_B = \epsilon_0 E^2 = \frac{1}{\mu_0} B^2 = \epsilon_0 \bar{E}_0^2 \sin^2(kx - \omega t)$$

Poynting Vector $\left(\vec{S} = \frac{1}{\mu_0} \vec{E} \times \vec{B} \right)$:

The direction of the Poynting Vector is the direction of energy flow and the magnitude

$$\left(S = \frac{1}{\mu_0} EB = \frac{E^2}{\mu_0 c} = \frac{1}{A} \frac{dU}{dt} \right)$$

Is the energy per unit time per unit area (units of Watts/m²).

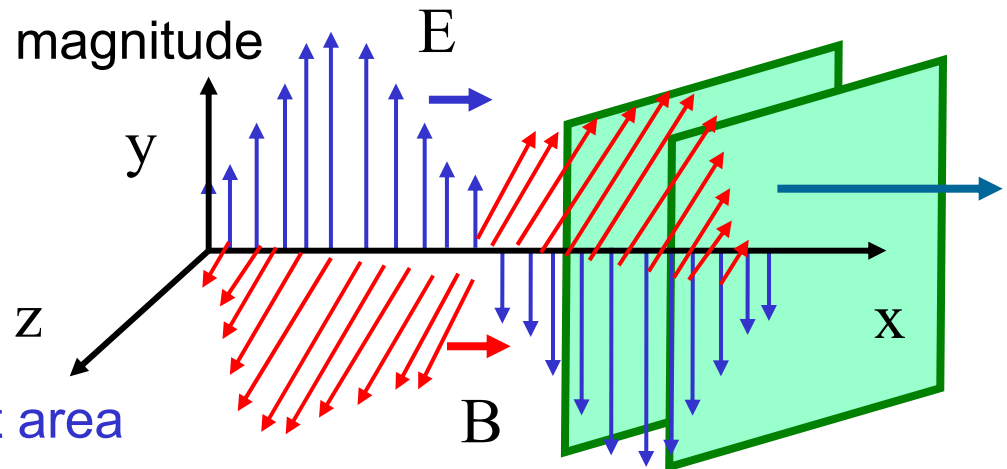

Energy Transport - Poynting Vector cont.

Proof:

$$dU_{total} = u_{total}V = \epsilon_0 E^2 Acdt \text{ so}$$

$$S = \frac{1}{A} \frac{dU}{dt} = \epsilon_0 c E^2 = \frac{E^2}{\mu_0 c} = \frac{E_0^2}{\mu_0 c} \sin^2(kx - \omega t)$$

Intensity of the Radiation (Watts/m²):

The intensity, I , is the average of S as follows:

$$I = \bar{S} = \frac{1}{A} \frac{d\bar{U}}{dt} = \frac{E_0^2}{\mu_0 c} \left\langle \sin^2(kx - \omega t) \right\rangle = \frac{E^2}{2\mu_0 c}.$$



✚ Ohm's law

$$\bar{J} = \sigma \bar{E}$$

✚ Skin depth

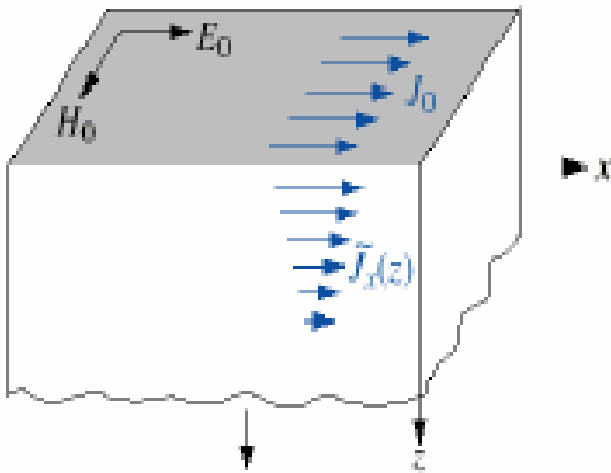

Current density decays exponentially from the surface into the interior of the conductor

Phasors

Fictitious way of dealing with AC circuits

$$i(t) = \text{Re} \left\{ I e^{j\omega t} \right\}$$

$$I = \frac{V_s}{R + j\omega L}$$

Measurable quantity

Phasor (not real)

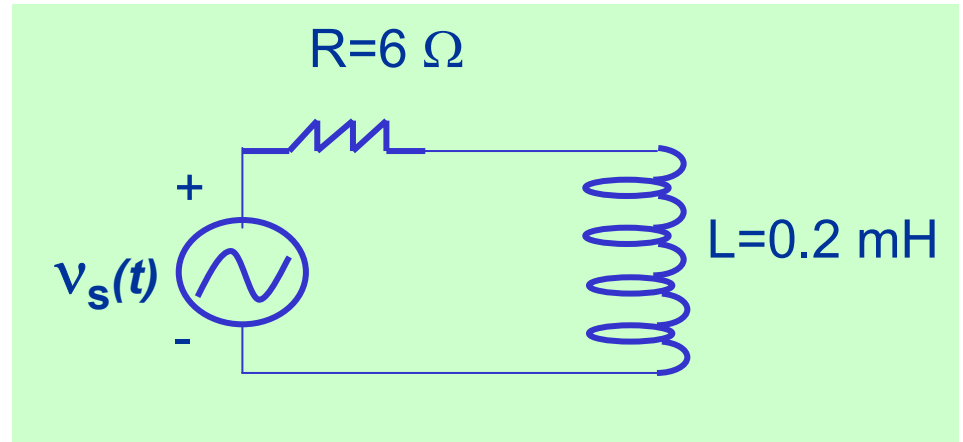

Phasors cont.

- ✚ Phasors in lumped circuit analysis have no space components
- ✚ Phasors in distributed circuit analysis (RF) have a space component because they act as waves

$$v(x, t) = \text{Re}\{V_0 e^{\pm j\beta x} e^{j\omega t}\} = V_0 \cos(\omega t \pm \beta x)$$



Displacement Current

Observe that the vector field $\frac{1}{c} \frac{\partial E}{\partial t}$ appears to form a continuation of the conduction current distribution. Maxwell called it the displacement current, and the name has stuck although it no longer seems very appropriate.

We can define a displacement current density J_d , to be distinguished from the conduction current density J , by writing

$$\text{curl } B = \frac{4\pi}{c} (J + J_d)$$

and define

$$J_d = \frac{1}{4\pi} \frac{\partial E}{\partial t}$$

It turns out that physical displacement currents lead to small magnetic fields that are difficult to detect. To see this effect, we need rapidly changing fields (Hertz experiment).



Displacement Current

Example: $I = I_d$ in a circuit branch having a capacitor

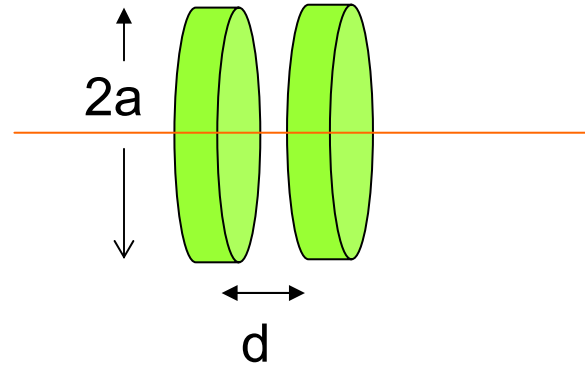
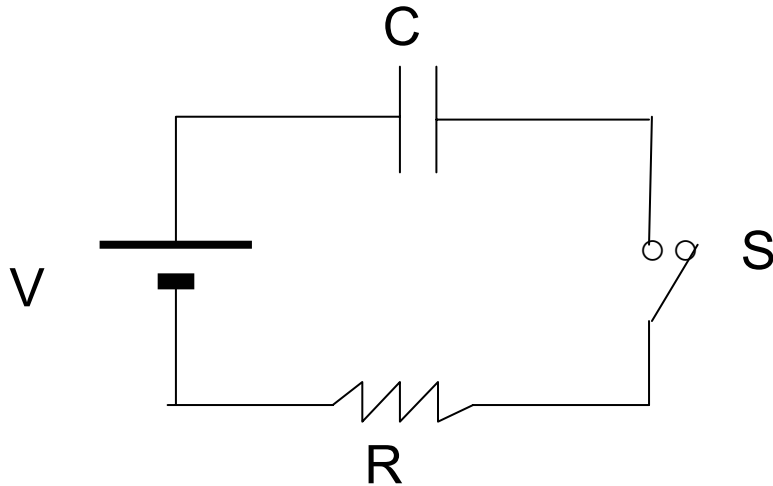

$$E(t) = \frac{V(t)}{d} = \frac{Q(t)}{Cd}$$

The displacement current density is given by

$$J_d = \frac{1}{4\pi} \frac{\partial E(t)}{\partial t} = \frac{1}{4\pi Cd} \frac{\partial Q(t)}{\partial t} = \frac{I(t)}{4\pi Cd}$$

Displacement Current

The direction of the displacement current is in the direction of the current.
The total current of the displacement current is

$$I_d = A \cdot J_d = \frac{A \cdot I}{4\pi C \cdot d} = I$$

Thus the current flowing in the wire and the displacement current flowing in the condenser are the same.

How about the magnetic field inside the capacitor? Since there is no real current in the capacitor,

$$\text{curl } B = \frac{1}{c} \frac{\partial E}{\partial t}$$

Integrating over a circular area of radius r ,

$$\int_{S(r)} \text{curl } B \cdot da = \frac{1}{c} \int_{S(r)} \frac{\partial E}{\partial t} \cdot da$$



Displacement Current

$$l.h.s = \int_{S(r)} \text{curl} B \cdot da = \int_{C(r)} B \cdot ds = 2\pi B \cdot r$$

$$\begin{aligned} r.h.s &= \frac{1}{c} \frac{\partial}{\partial t} \int_{S(r)} E \cdot da = \frac{\pi r^2}{c} \frac{\partial E}{\partial t} \\ &= \frac{\pi r^2}{cd} \frac{\partial V}{\partial t} = \frac{\pi r^2}{cd} \frac{1}{C} \frac{\partial Q}{\partial t} = \frac{\pi r^2}{cd} \frac{I}{C} = \frac{4\pi I}{c} \frac{r^2}{a^2} \end{aligned}$$

Thus the magnetic field in the capacitor is

$$2\pi B \cdot r = \frac{4\pi I}{c} \frac{r^2}{a^2} \rightarrow B(r) = \frac{2Ir}{ca^2}$$

$$2\pi B \cdot r = \frac{4\pi I}{c} \rightarrow B(r) = \frac{2I}{cr} \quad (\text{at the edge of the capacitor})$$

This is the same as that produced by a current flowing in an infinitely long wire.



Wave in Elastic Medium

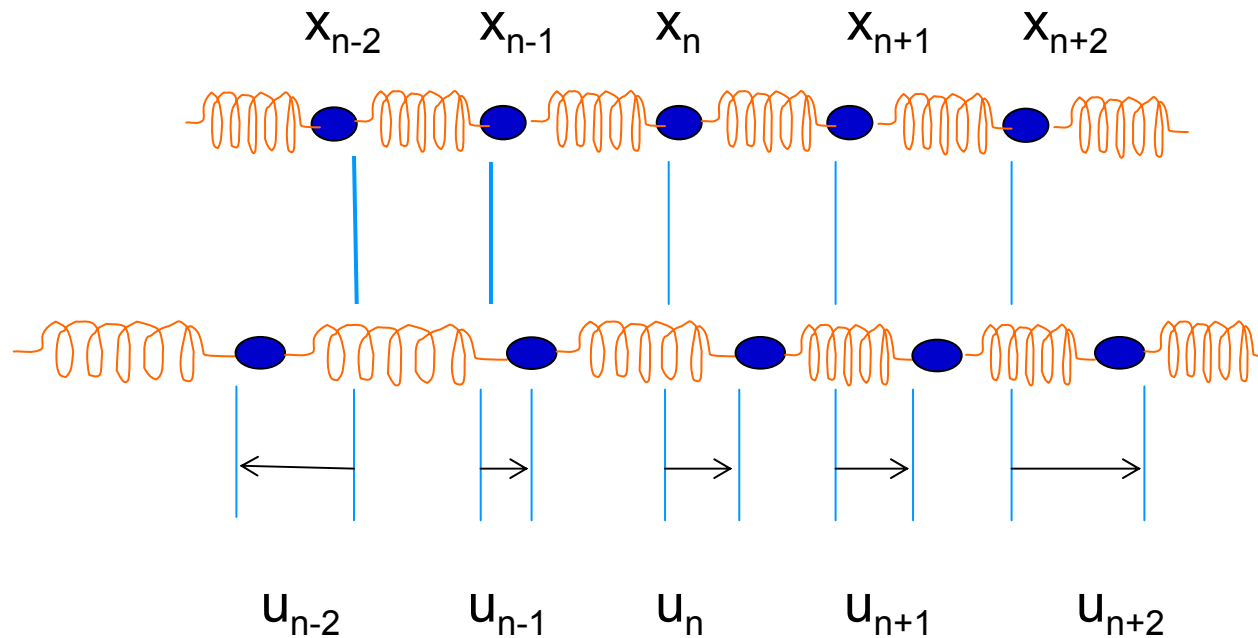

The equation of motion for n^{th} mass is

$$m \frac{\partial^2 u_n}{\partial t^2} = -k(u_n - u_{n-1}) + k(u_{n+1} - u_n) = k(u_{n-1} - 2u_n + u_{n+1})$$

By expanding the displacement $u_{n\pm 1}(t) = u(x_{n\pm 1}, t)$ around x_n , we can convert the equation into a DE with variable x and t .

Wave in Elastic Medium

$$u_{n\pm 1}(t) = u(x_n \pm \Delta x, t) = u(x_n, t) + \frac{\partial u(x_n, t)}{\partial x_n} (\pm \Delta x) + \frac{1}{2} \frac{\partial^2 u(x_n, t)}{\partial x_n^2} (\pm \Delta x)^2 + \dots$$

$$m \frac{\partial^2 u(x_n, t)}{\partial t^2} = k \Delta x^2 \frac{\partial^2 u(x_n, t)}{\partial x_n^2} \rightarrow \frac{m}{\Delta x} \frac{\partial^2 u(x_n, t)}{\partial t^2} = k \Delta x \frac{\partial^2 u(x_n, t)}{\partial x_n^2}$$

Define $K \equiv k \Delta x$ as the elastic modulus of the medium and $\rho = m / \Delta x$ is the mass density. In continuous medium limit $\Delta x \longrightarrow 0$, we can take out n .

$$\rho \frac{\partial^2 u(x, t)}{\partial t^2} = K \frac{\partial^2 u(x, t)}{\partial x^2}$$

We examine a wave equation in three dimensions. Consider a physical quantity that depends only on z and time t .



Wave along z-axis

$$\frac{\partial^2 \Psi(z,t)}{\partial t^2} = v^2 \frac{\partial^2 \Psi(z,t)}{\partial z^2}$$

We prove that the general solution of this DE is given by

$$\Psi(z,t) = f(z - vt) + g(z + vt)$$

f and g are arbitrary functions.

Insert a set of new variables,

$$\xi = z - vt \quad \text{and} \quad \eta = z + vt$$

Then

$$\frac{\partial}{\partial z} = \frac{\partial \xi}{\partial z} \frac{\partial}{\partial \xi} + \frac{\partial \eta}{\partial z} \frac{\partial}{\partial \eta} = \frac{\partial}{\partial \xi} + \frac{\partial}{\partial \eta}$$

and

$$\frac{\partial}{\partial t} = \frac{\partial \xi}{\partial t} \frac{\partial}{\partial \xi} + \frac{\partial \eta}{\partial t} \frac{\partial}{\partial \eta} = -v \frac{\partial}{\partial \xi} + v \frac{\partial}{\partial \eta}$$



Wave along z-axis

$$\longrightarrow \left(\frac{\partial}{\partial \xi} + \frac{\partial}{\partial \eta} \right)^2 \Psi = \left(\frac{\partial}{\partial \xi} - \frac{\partial}{\partial \eta} \right)^2 \Psi$$

thus
$$\frac{\partial^2}{\partial \eta \partial \xi} \Psi = 0$$

From this equation:

$$\frac{\partial}{\partial \eta} \frac{\partial \Psi}{\partial \xi} = 0 \rightarrow \frac{\partial \Psi}{\partial \xi} = F(\xi)$$

$$\frac{\partial \Psi}{\partial \xi} = F(\xi) \rightarrow \Psi = \int F(\xi) d\xi + g(\eta) \equiv f(\xi) + g(\eta)$$

Thus

$$\Psi(z, t) = f(z - vt) + g(z + vt)$$



Radiation

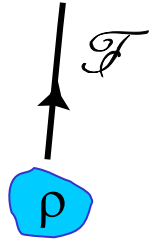

Charges and currents

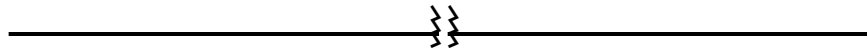

Great Distance

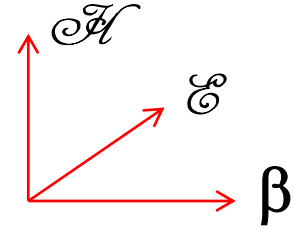

Approximate plane waves

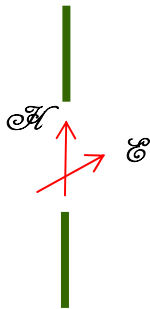

Aperture fields

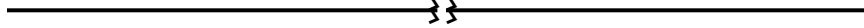

Great Distance

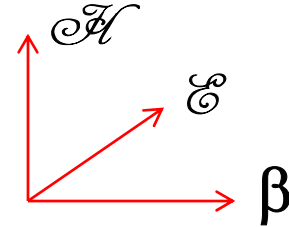

Approximate plane waves

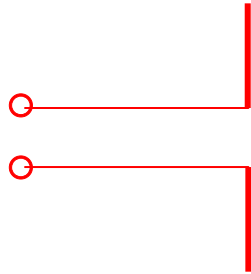

Transmission line fed dipole

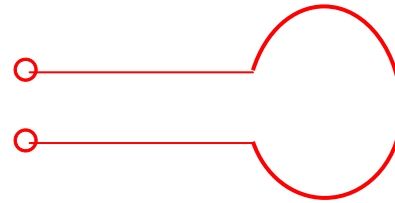

Transmission line fed current loop

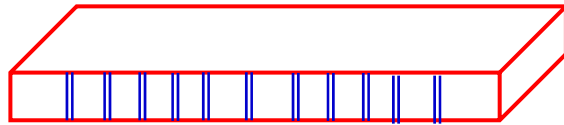

Slots in waveguide

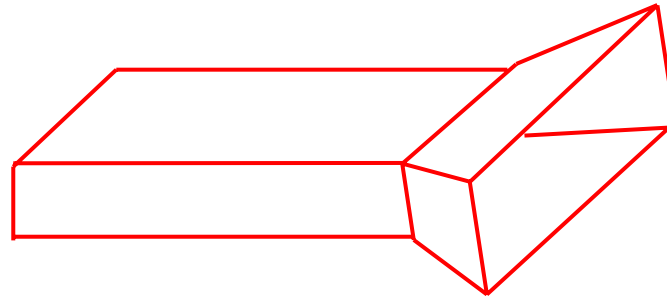

Waveguide fed horn

Radiation

In the time domain the electric scalar potential $\phi(r_2, t)$ and the magnetic vector potential $A(r_2, t)$ produced at time t at a point r_2 by charge and current distribution $\rho(r_1)$ and $J(r_1)$ are given by

$$\phi(r_2, t) = \frac{1}{4\pi\epsilon_0} \int_v \frac{\rho(r_1, t - r_{12}/c)}{r_{12}} dv$$

and

$$A(r_2, t) = \frac{\mu_0}{4\pi} \int_v \frac{J(r_1, t - r_{12}/c)}{r_{12}} dv$$

Sinusoidal steady state

$$\phi(r_2) = \frac{1}{4\pi\epsilon_0} \int_v \frac{\rho(r_1) e^{-j\beta r_{12}}}{r_{12}} dv$$

$e^{-j\beta r_{12}}$ is the phase retardation factor

$$A(r_2) = \frac{\mu_0}{4\pi} \int_v \frac{J(r_1) e^{-j\beta r_{12}}}{r_{12}} dv$$



We start with

$$B = \text{curl } A \quad \text{and} \quad E = -\text{grad } \phi - j\omega A$$

Charge conservation:

$$\text{div } J + \frac{\partial \rho}{\partial t} = 0 \quad \xrightarrow{\text{Sinusoidal steady state}} \quad \text{div } J + j\omega \rho = 0$$

Because ρ and J are related by the charge conservation equation, ϕ and A are also related. In the time domain,

$$\text{div } A + \mu_0 \epsilon_0 \frac{\partial \phi}{\partial t} = 0 \quad \xrightarrow{\text{Sinusoidal steady state}} \quad \text{div } A + j\omega \mu_0 \epsilon_0 \phi = 0$$

With $\omega \neq 0$

$$\phi = -\frac{\text{div } A}{j\omega \mu_0 \epsilon_0}$$

Substituting for ϕ :

$$\begin{aligned} H &= \frac{1}{\mu_0} \text{curl } A \\ E &= \frac{1}{j\omega \mu_0 \epsilon_0} \text{grad div } A - j\omega A \\ &= -\frac{j\omega}{\beta^2} \text{grad div } A - j\omega A \end{aligned}$$

$$c = \frac{1}{\sqrt{\mu_0 \epsilon_0}} \quad \omega = c\beta$$



Near and far fields

We consider the transmission characteristics of a particular antenna in the form of a straight wire, carrying an oscillatory current whose length is much less than the electromagnetic wavelength at the operating frequency. Such antenna is called a *short electric dipole*.

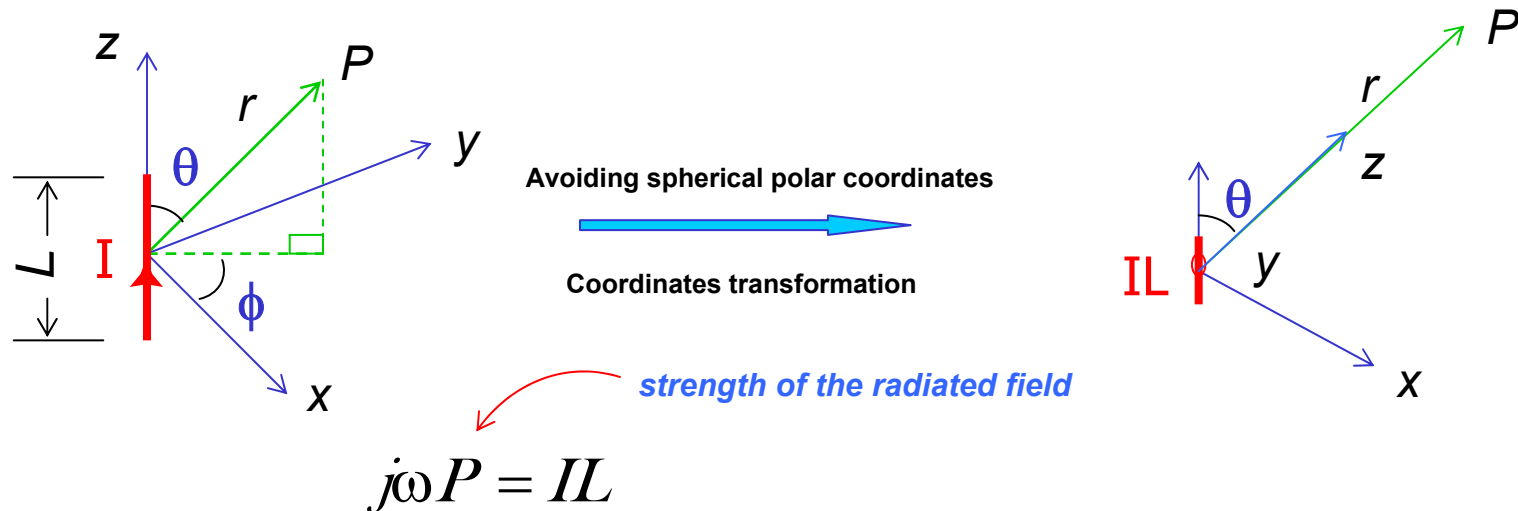

The components of the dipole vector in these coordinates are

$$P = \begin{bmatrix} p_x \\ 0 \\ p_z \end{bmatrix} = \begin{bmatrix} -p \sin \theta \\ 0 \\ p \cos \theta \end{bmatrix}$$

Dipole radiation

The retarded vector potential is then

$$A = \frac{\mu_0}{4\pi} \int_v \frac{J e^{-\beta z}}{z} dv$$

Where we used $\beta = \frac{\omega}{c}$. We also replace $\int_v J dv$ by $IL = j\omega P$ and obtain

$$A = \frac{\mu_0}{4\pi} (j\omega P) \frac{e^{-\beta z}}{z}$$

$$\text{curl } A \approx \frac{j\omega\mu_0}{4\pi z} \begin{vmatrix} i & j & k \\ \partial & \partial & \partial \\ \partial x & \partial y & \partial z \\ P_x e^{-\beta z} & 0 & P_z e^{-\beta z} \end{vmatrix} = \frac{j\omega\mu_0}{4\pi z} \begin{bmatrix} 0 \\ j\beta P_x e^{-\beta z} \\ 0 \end{bmatrix}$$

Thus the radiation component of the magnetic field has a y component only given by

$$H_y = -j\beta j\omega \frac{P_x e^{-\beta z}}{4\pi z}$$



Dipole radiation

Electric field:

We start with

$$\text{div}A \approx \frac{\partial A_z}{\partial z} = \frac{j\omega\mu_0 P_z (-j\beta)e^{-j\beta z}}{4\pi z}$$

then

$$\text{grad div}A = \frac{\mu_0 j\omega P_z (-j\beta)}{4\pi z} \begin{bmatrix} 0 \\ 0 \\ (-j\beta)e^{-j\beta z} \end{bmatrix}$$

The first term we require for the electric field is simply

$$\frac{-j\omega}{\beta^2} \text{grad div}A = \frac{-\omega^2 \mu_0 e^{-j\beta z}}{4\pi z} \begin{bmatrix} 0 \\ 0 \\ P_z \end{bmatrix}$$

The second term we require for the electric field is

$$-j\omega A = \frac{-\omega^2 \mu_0 e^{-j\beta z}}{4\pi z} \begin{bmatrix} -P_x \\ 0 \\ -P_z \end{bmatrix}$$



Dipole radiation

Electric field:

The electric field is the sum of these two terms. It may be seen that the z components cancel, and we are left with only x component of field given by

$$E_x = \frac{\omega^2 \mu_0 M_x e^{-j\beta z}}{4\pi z}$$

Note that this expression also fits our expectation of an approximately uniform plane wave. The ratio of electric to magnetic field amplitudes is

$$\frac{E_x}{H_y} = \frac{\mu_0 \omega^2}{\beta \omega} = \mu_0 \frac{\omega}{\beta} = \mu_0 c = \mu_0 \sqrt{\frac{1}{\mu_0 \epsilon_0}} = \sqrt{\frac{\mu_0}{\epsilon_0}} = \eta$$

as expected for a uniform plane wave.



Dipole radiation

We will now translate the field components into the spherical polar coordinates.

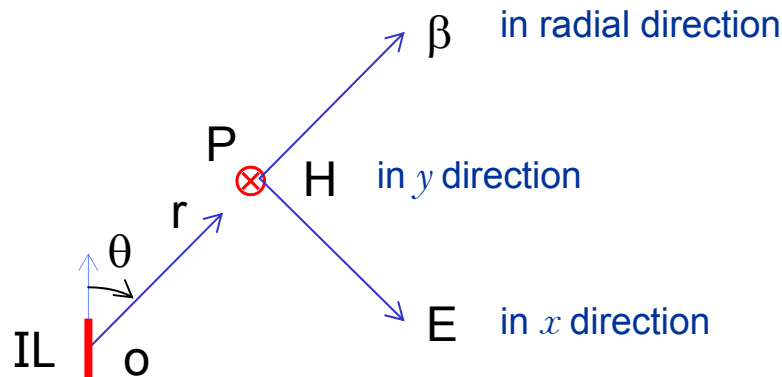

since $P_x = -P \sin \theta$ we have

$$E_\theta = E_x = \frac{\omega^2 \mu_0 P \sin \theta e^{-\beta r}}{4\pi r} \quad \text{and} \quad H_\phi = H_y = \frac{-\omega \beta P \sin \theta e^{-\beta r}}{4\pi r}$$

The Poynting vector $\frac{1}{2}(\bar{E} \times \bar{H}^*)$ is in r direction and has the value

$$S_r = S_z = \frac{\mu_0 \omega^3 \beta |P|^2 \sin^2 \theta}{2(4\pi r)^2}$$

This vector (real) gives the real power per unit area flowing across an element of area \perp to r at a great distance.

Radiation pattern

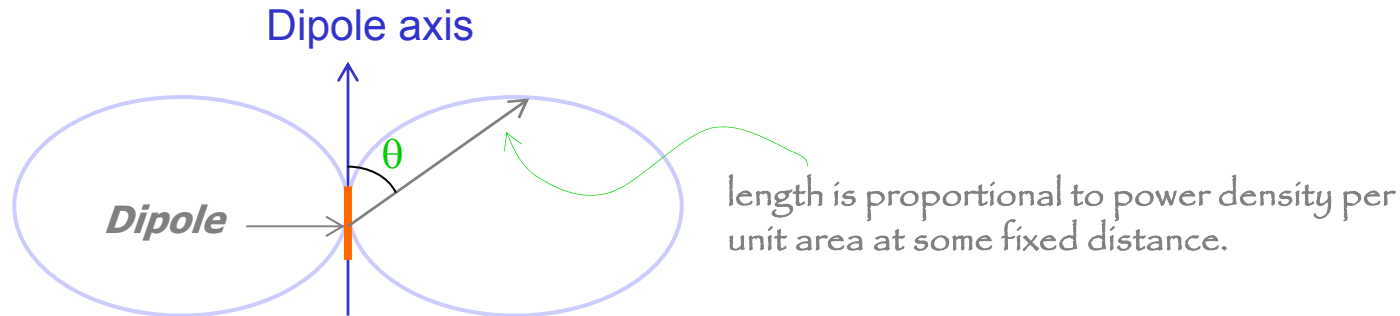

Note: No radiation takes place along the dipole axis, and the radiation pattern has axial symmetry, with maximum radiation being in the equatorial plane.

Because of the non-uniform nature of the pattern we have the concept of antenna gain, which for a lossless antenna is the power flow per unit area for the antenna in the most efficient direction over the power flow per unit area we would obtain if the energy were uniformly radiated in all directions. The total radiated power is

$$W = \int_{\theta=0}^{\pi} \int_{\phi=0}^{2\pi} \Re\{S_r\} (r^2 \sin\theta d\theta d\phi) = \frac{\mu_0 \omega^3 \beta |P|^2}{32\pi^2} \int_{\theta=0}^{\pi} \sin^3 \theta d\theta \int_{\phi=0}^{2\pi} d\phi$$

$$= \frac{\mu_0 \omega^3 \beta |P|^2}{12\pi^2}$$

The average radiated power per unit area is

$$\frac{W}{4\pi r^2} = \frac{\mu_0 \omega^3 \beta |P|^2}{48\pi^2 r^2}$$

Hence the antenna gain, g defined by

$$g = \frac{\text{radiated power/unit area in the most efficient direction}}{\text{average radiated power/unit area over a large sphere}}$$

becomes

$$g = \frac{\omega^3 \beta |P|^2}{32\pi^2 r^2} \frac{48\pi^2 r^2}{\omega^3 \beta |P|^2} = \frac{3}{2}$$

This result is the gain of a small dipole.



Radiation resistance

Recall

$$W = \frac{\mu_0 \omega^3 \beta |P|^2}{12\pi} = \frac{\mu_0 \omega \beta |I|^2 L^2}{12\pi}$$

The radiation resistance R_r is defined as the equivalent resistance which would absorb the same power W from the same current I , i.e.

$$W = \frac{R_r |I|^2}{2}$$

Combining these results we obtain

$$R_r = \frac{\mu_0 \omega \beta L^2}{6\pi}$$

Using $\omega = c\beta$, $\beta = 2\pi/\lambda$, $c = 1/\sqrt{\mu_0 \epsilon_0}$ and $\eta = \sqrt{\mu_0/\epsilon_0}$, we find

$$R_r = \frac{\eta}{6\pi} (\beta L)^2 = \left(\frac{2\pi}{3}\right) \eta \left(\frac{L}{\lambda}\right)^2 \quad \longrightarrow \quad R_r \approx 20(\beta L)^2 \Omega \quad (\eta \approx 120\pi \Omega)$$



Consider an arbitrary system of radiating currents

We start with the vector potential

$$A(r_2) = \frac{\mu_0}{4\pi} \int_v \frac{J(r_1) e^{-j\beta r_{12}}}{r_{12}} dv$$

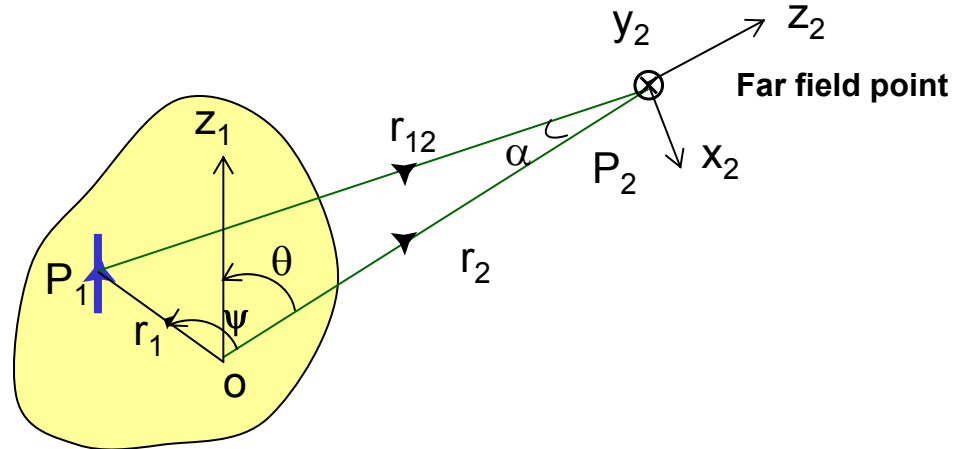

We will regard r_{12} fixed. For P_2 a distance point, we replace r_{12} with r_2

So

$$A(r_2) = \frac{\mu_0}{4\pi r_2} \int_v J(r_1) e^{-j\beta r_{12}} dv$$

Approximations for r_{12} in $e^{-j\beta r_{12}}$ require more care, since phase differences in radiation effects are crucial. We use the following approximation

$$r_2 = r_1 + r_{12}$$

$$r_2 \approx r_1 \cos \psi + r_{12}$$

$$r_{12} \approx r_2 - r_1 \cos \psi$$

$$\Rightarrow A(r_2) = \frac{\mu_0 e^{-j\beta r_2}}{4\pi r_2} \int_v J(r_1) e^{+j\beta r_1 \cos \psi} dv$$

factor $e^{+j\beta r_1 \cos \psi}$ **expresses the phase advance of the radiation from the element at P_1 relative to the phase at the origin.**



We have

$$A(r_2) = \frac{\mu_0 e^{-\beta r_2}}{4\pi r_2} \mathfrak{R}$$

where

$$\mathfrak{R} = \int_V J(r_1) e^{\beta r_1 \cos \psi} dV$$

\mathfrak{R} is called the **radiation vector**. It depends on the **internal geometrical distribution** of the currents and on the **direction of P_2 from the origin O** , but not on the **distance**.

The factor $\frac{\mu_0 e^{-\beta r_2}}{4\pi r_2}$ depends only on the distance from the origin O to the field point P_2 but not on the internal distribution of the currents in the antenna.

The radiation vector \mathfrak{R} can be regarded as an **effective dipole** equal to the sum of the individual dipole elements JdV , each weighted by phase factor $e^{\beta r_1 \cos \psi}$, which depends on the **phase advance** $\beta r_1 \cos \psi$ of the element in relation to the origin, and direction OP_2 .

$$H_\theta = \beta \frac{e^{-\beta r}}{4\pi r} \mathfrak{R}_\phi \quad \text{and} \quad H_\phi = -\beta \frac{e^{-\beta r}}{4\pi r} \mathfrak{R}_\theta$$

$$E_\theta = \eta H_\phi \quad \text{and} \quad E_\phi = -\eta H_\theta$$



Small circular loop

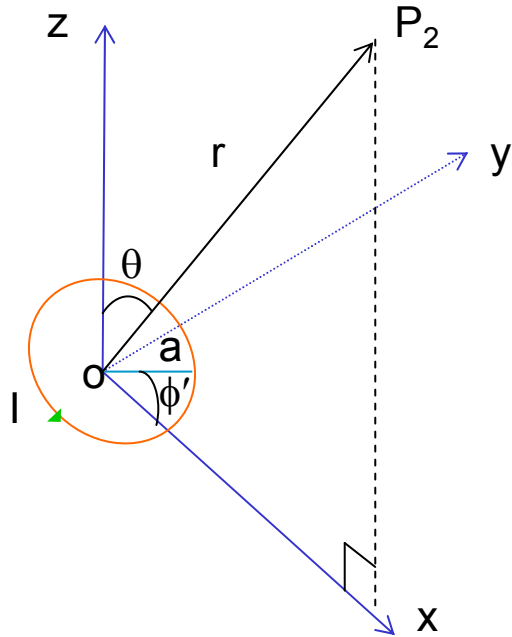

Calculate the radiated fields and power at large distance.

Using the symmetry the results will be independent of the azimuth coordinate ϕ .

The spherical polar coordinates of a point P_1 at a general position on the loop are $(a, \pi/2, \phi')$.

ψ being the angle between OP_1 and OP_2 with a unit vector in the direction of OP_1 $(\cos \phi', \sin \phi', 0)$ and a unit vector in the direction of OP_2 $(\sin \theta, 0, \cos \theta)$:

We have $\cos \psi = \sin \theta \cos \phi'$

The radiation vector is then given by

$$\mathfrak{R}(\theta, 0) = \int J(r_1) \cdot \hat{u}_\phi e^{j\beta a \sin \theta \cos \phi'} dv \xrightarrow{\text{filamentary current}} \mathfrak{R}(\theta, 0) = \int I dr_1 \cdot \hat{u}_\phi e^{j\beta a \sin \theta \cos \phi'}$$

$$\mathfrak{R}(\theta, 0) = \int_0^{2\pi} I a e^{j\beta a \sin \theta \cos \phi'} \cos \phi' d\phi' \xrightarrow{\quad} \mathfrak{R}(\theta, 0) \approx I a \int_0^{2\pi} (1 + j\beta a \sin \theta \cos \phi') \cos \phi' d\phi'$$

$$\mathfrak{R}_\phi(\theta, 0) = j\beta \pi I a^2 \sin \theta$$



Electric and magnetic fields

$$H_{\theta} = \frac{j\beta e^{-j\beta r}}{4\pi r} \mathfrak{R}_{\phi} = \frac{-(\beta a)^2 I \sin \theta}{4r} e^{-j\beta r} \quad \text{and} \quad E_{\phi} = -\eta H_{\theta} = \frac{(\beta a)^2 \eta I \sin \theta}{4r} e^{-j\beta r}$$

Poynting vector

$$S_r = -\frac{1}{2} E_{\phi} H_{\theta}^* = \frac{(\beta a)^4 \eta I^2 \sin^2 \theta}{32r^2}$$

Total power radiated

$$W = \int_{\phi=0}^{2\pi} \int_{\theta=0}^{\pi} S_r r \sin \theta d\phi r d\theta \quad \text{Substituting for } S_r \text{ and using } \sin^3 \theta = \frac{1}{4}(3 \sin \theta - \sin 3\theta)$$

$$W = \frac{\pi \eta |I|^2 (\beta a)^4}{12}$$

Radiation resistance

$$W = \frac{1}{2} \mathfrak{R}_r |I|^2 \quad \longrightarrow \quad \mathfrak{R}_r = \frac{\pi \eta}{6} (\beta a)^4 \quad \longrightarrow \quad \mathfrak{R}_r = 20\pi^2 (\beta a)^4 \Omega \quad (\eta = 120\pi \Omega)$$

